

SVENBOX

OFFICE SOLUTIONS

cennik 2015

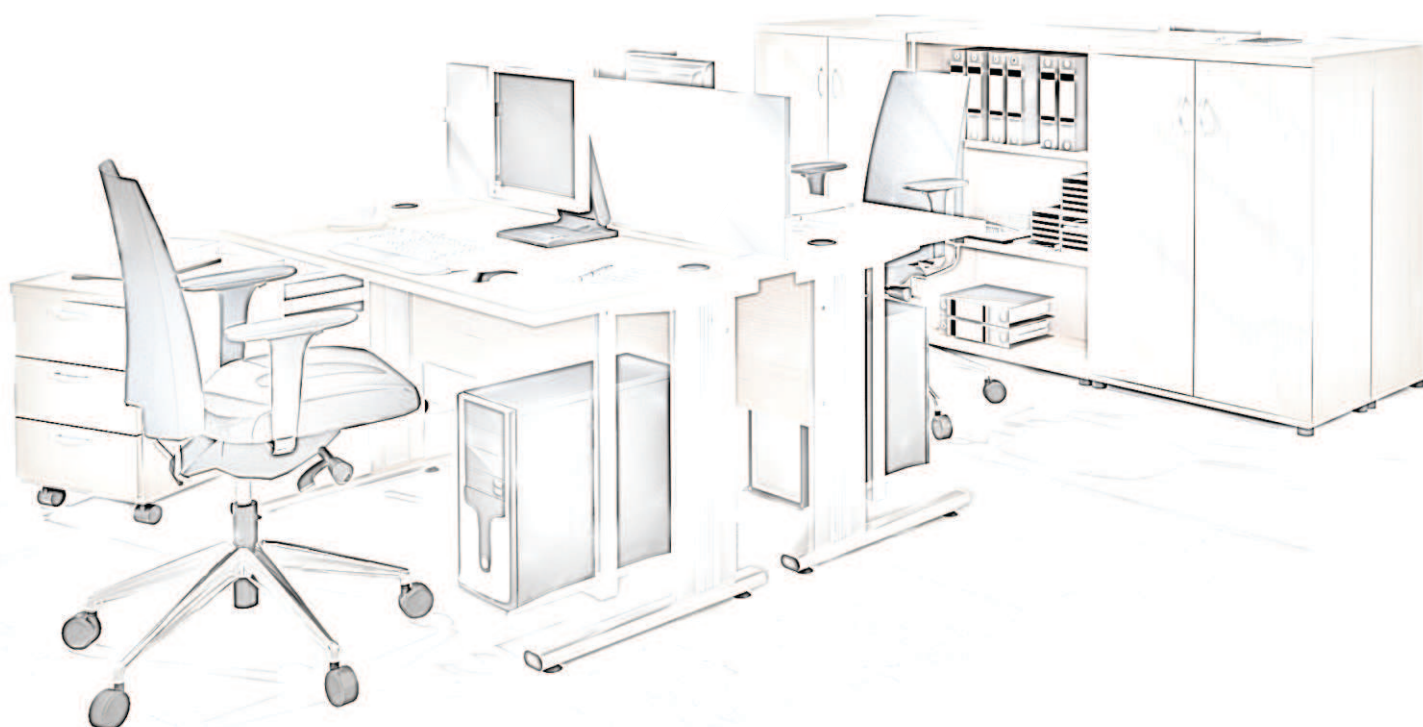

SVENBOX CLASSIC	4
SVENBOX INVEST	28
ECHO	54
LADA SVEN	62
LADA VEROVA	66

► SVENBOX CLASSIC

ELEMENTY PŁYTOWE

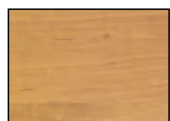

28 - OLCHA



29 - CALVADOS

BIURKA / PRZYSTAWKI
- blat
- osłona płytowa
- nogi płytowe

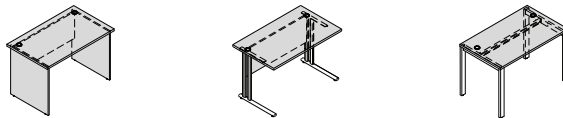

SZAFY / KONTENERY
- wieniec górny
- wieniec dolny
- font płytowy



UKŁADY WIELOSTANOWISKOWE / STOŁY KONFERENCYJNE / STOLIKI
- blat
- nogi płytowe
- blenda płytowa

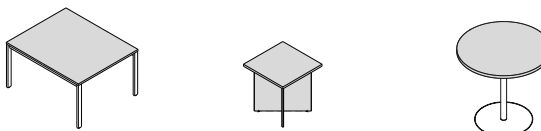

ELEMENTY PŁYTOWE



84 - POPIEL

PANELE PŁYTOWE

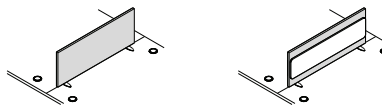

SZAFKA ŻALUZJOWA
- wieniec górny
- wieniec dolny
- korpus

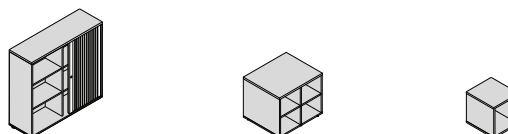

ELEMENTY DODATKOWE

ELEMENTY METALOWE



09 - ALUMINIUM

BIURKA / PRZYSTAWKI
- stelaż metalowy
- noga podpierająca

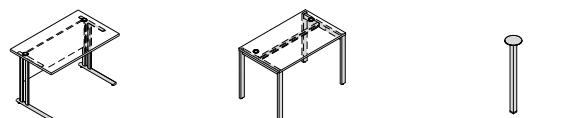

UKŁADY WIELOSTANOWISKOWE / STOŁY KONFERENCYJNE (bez stołu PSC06)
- stelaż metalowy

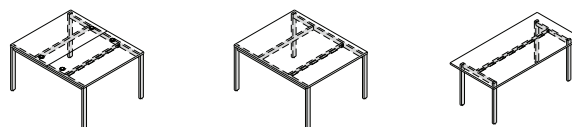

OSŁONA RASTROWA

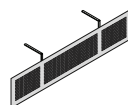

09 - ALUMINIUM



15 - BIAŁY POŁYSK

KOLUMNA



ELEMENTY TKANINOWE



NX2 - BEŻOWY



NX3 - POMARAŃCZ



NX5 - CZERWONY

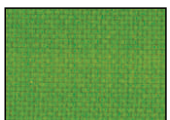

NX9 - ZIELONY



NX10 - SZARY



NX15 - GRANATOWY

PODUSZKA TKANINOWA

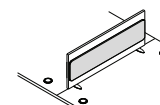

1. BIURKA

1.1 BLAT

plyta melaminowana 28mm, obrzeże PVC 2mm

STANDARD - blat z przelotami kablowymi $\varnothing 60$

biurka proste

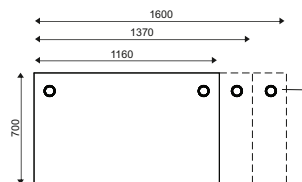
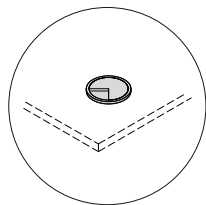
przelot kablowy $\varnothing 60$
kolor: 09 ALUMINIUM

biurka kształtowe

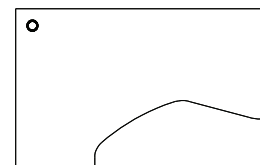
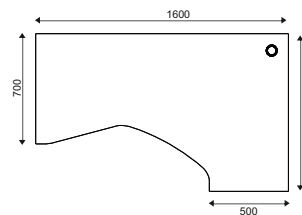
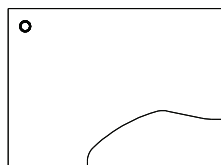
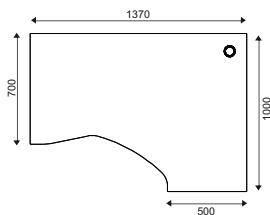

1. BIURKA

1.2 PODSTAWA

EKO_C

nogi płytowe - płyta melaminowana 18mm
blenda - płyta melaminowana 18mm

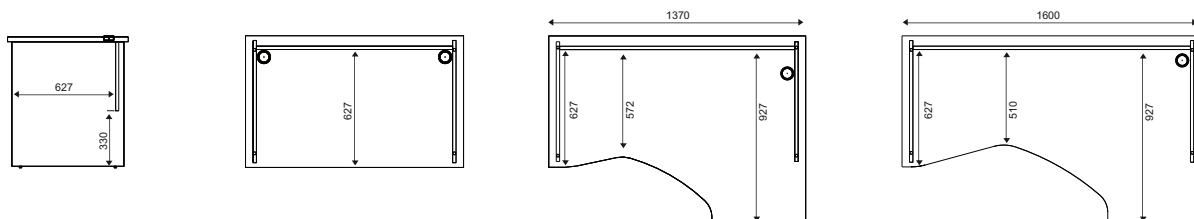
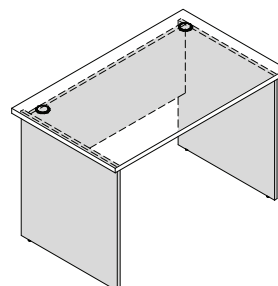

VIK_C

nogi metalowe - metal malowany proszkowo
blenda - płyta melaminowana 18mm

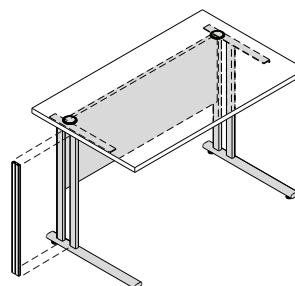

ELEMENT DODATKOWY
kanał kablowy BM01 (2 szt.)

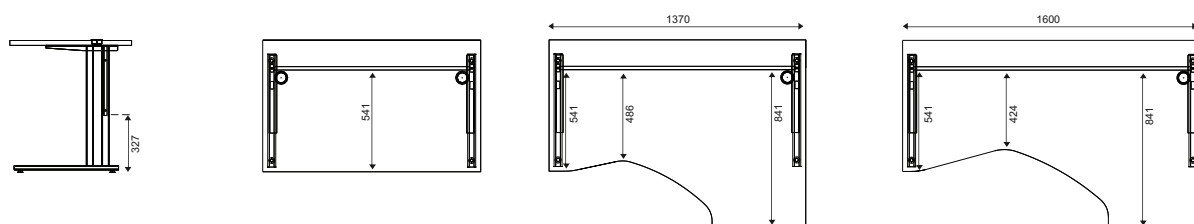

ART_C

stelaż - metal malowany proszkowo
profil 30x60

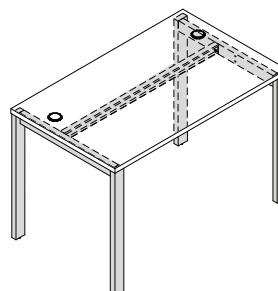

2. UKŁADY WIELOSTANOWISKOWE

2.1 BLAT

plyta melaminowana 28mm, obrzeże PVC 2mm

STANDARD

blat z przelotami kablowymi $\varnothing 60$

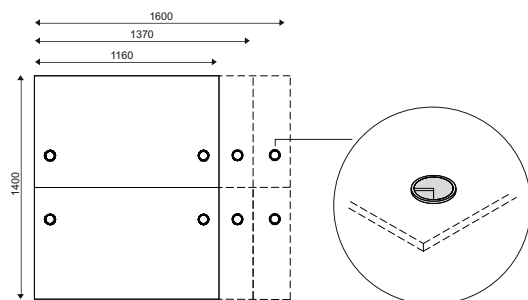

2.2 STELAŻ

metal malowany proszkowo
profil 30x60

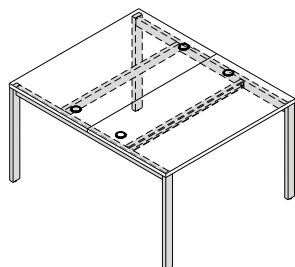

2.3 TWORZENIE UKŁADÓW WIELOSTANOWISKOWYCH

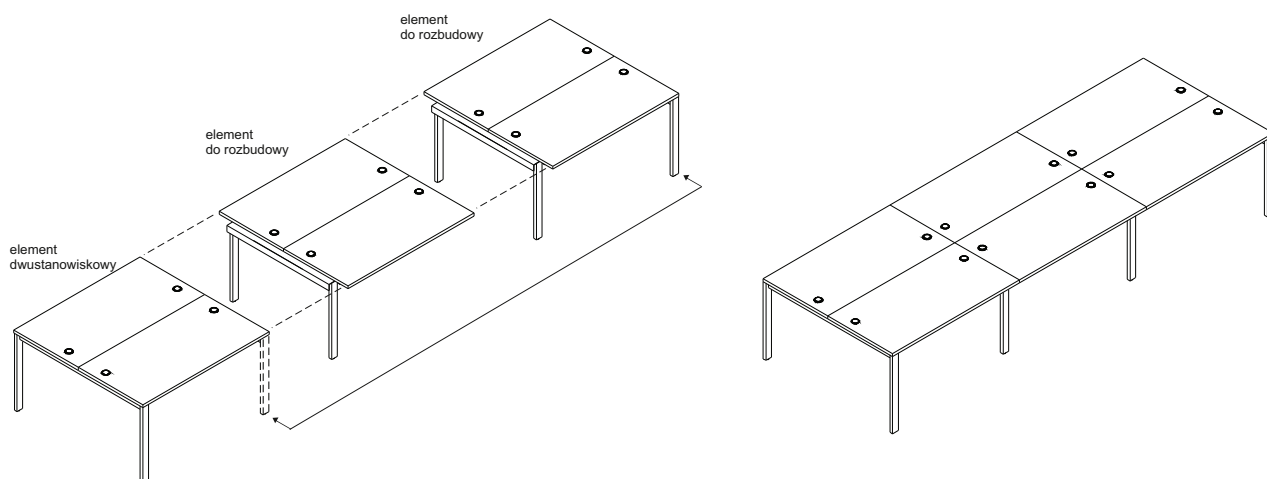

3. STOŁY KONFERENCYJNE

3.1 BLAT

plyta melaminowana 28mm, obrzeże PVC 2mm

STANDARD blat prosty

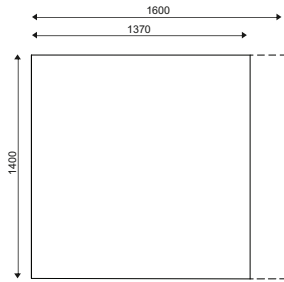

OPCJA blat prosty TOP ACCESS M05

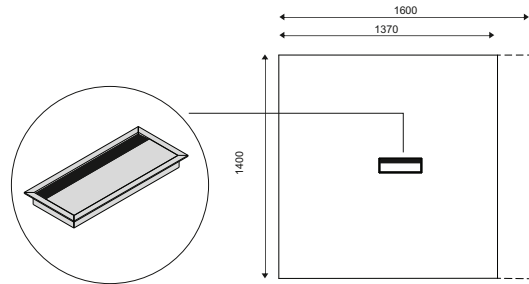

3.2 STELAŻ

metal malowany proszkowo
profil 30x60

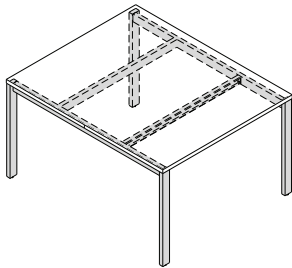

3.3 ROZBUDOWA STOŁU KONFERENCYJNEGO

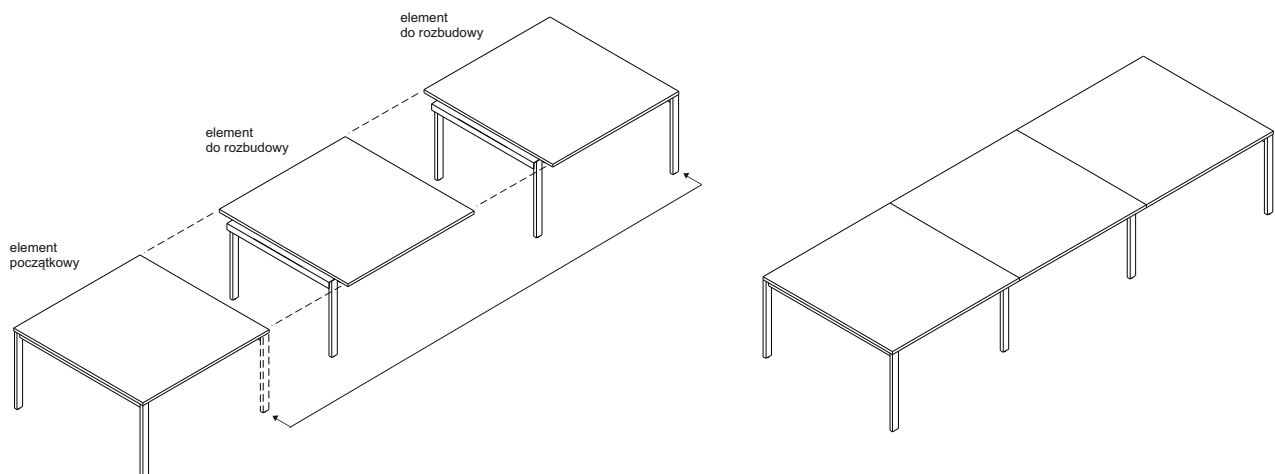

4. PANELE DO UKŁADÓW WIELOSTANOWISKORZYCH

PANELE PŁYTOWE

plyta melaminowana 18mm

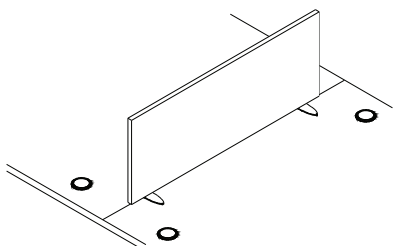
PANELE PŁYTOWE
Z PODUSZKAMI TKANINOWYMI

plyta melaminowana 18mm

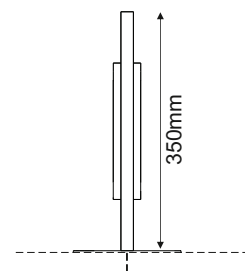
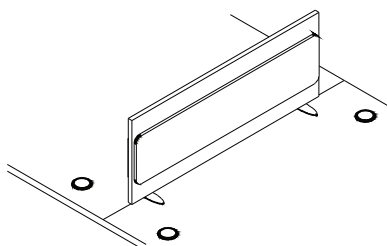

5. PRZYSTAWKI

5.1 BLAT

plyta melaminowana 28mm, obrzeże PVC 2mm

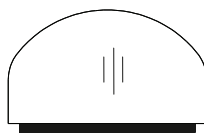
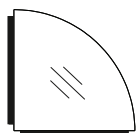

5.2 NOGA PODPIERAJĄCA

metal malowany proszkowo

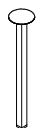
 profil 40x40 mm

6. STOŁY KONFERENCYJNE

6.1 BLAT

plyta melaminowana 28mm, obrzeże PVC 2mm

6.1 STELAŻ

PSC07 stół składany

stelaż - chrom

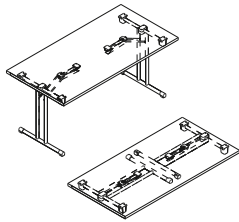
**CST08**

blat - ø800

talerz - stal nierdzewna, ø500

kolumna - metal malowany proszkowo, ø60

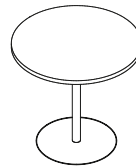
**PH62 PH64**

podstawa - płyta melaminowana 18mm

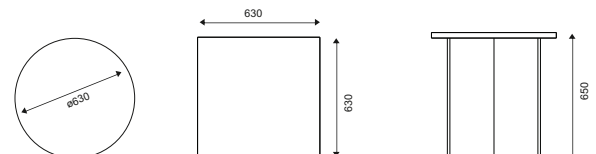
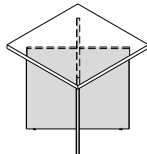
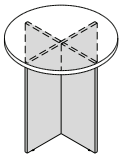
**PH53**

podstawa - płyta melaminowana 18mm

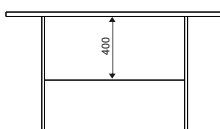
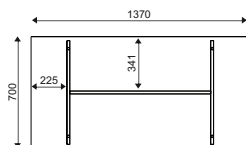
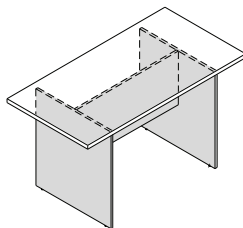
**PH56**

stelaż - metal malowany proszkowo
profil - 30x60 mm

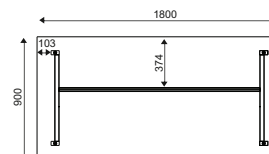
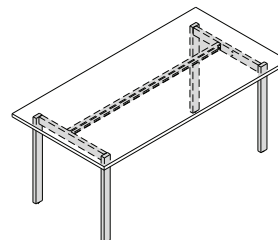

7. SZAFY I REGAŁY

7.1 WIENIEC GÓRNY

plyta melaminowana 28mm, obrzeże PVC 2mm

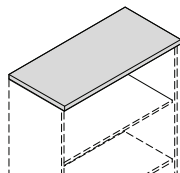

7.2 KORPUS

plyta melaminowana 18mm

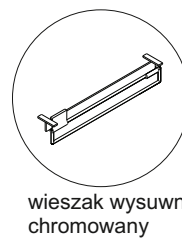
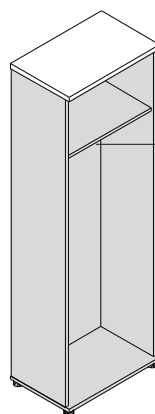
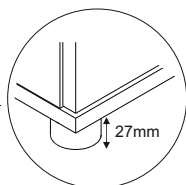
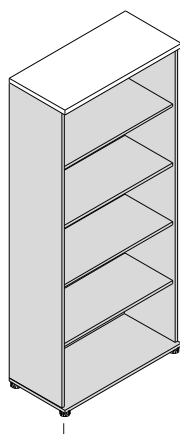

wieszak wysuwny chromowany

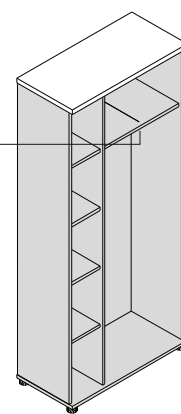

H62
szafa ubraniowa bez zamka

H52
szafa ubraniowo-aktowa bez zamka

7.3 FRONT DO SZAF I REGAŁÓW

drzwi płytowe
- płyta melaminowana 18mm
- zamek patentowy

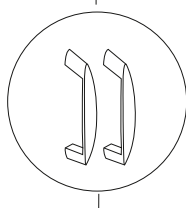
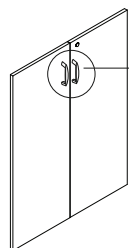

drzwi szklane(2szt.) 3OH,
- szkło hartowane bezbarwne
- bez zamka

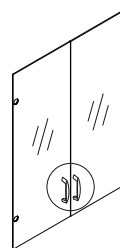

drzwi szklane(2szt.) 3OH
- ramka aluminiowa
- szkło hartowane mleczne
- bez zamka

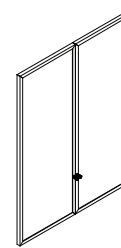

8. SZAFKA ŻALUZYJOWA

WIENIEC GÓRNY

plyta melaminowana 28mm,
obrzeże PVC 2mm

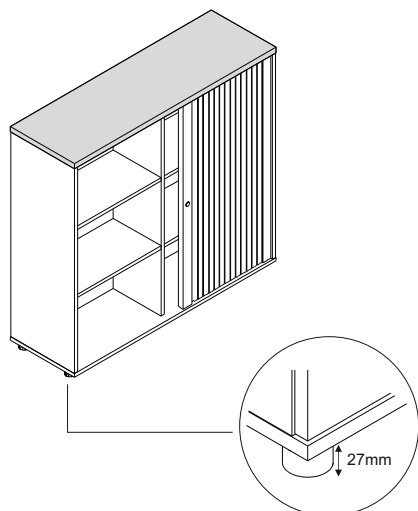

KORPUS

plyta melaminowana 18mm,
obrzeże PVC 2mm

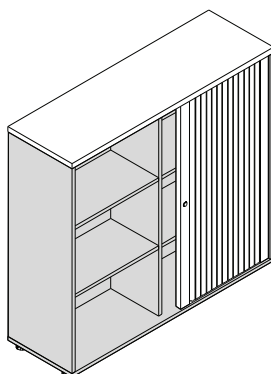

FRONT

żaluzja 09 - aluminium

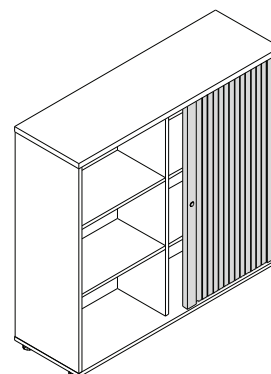

9. KONTENERY

KH13

WIENIEC GÓRNY

plyta melaminowana 28mm,
obrzeże PVC 2mm

KORPUS

plyta melaminowana 18mm

FRONT

plyta melaminowana 18mm
zamek centralny

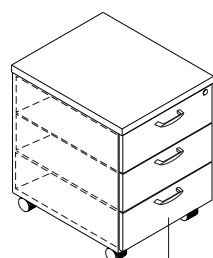

KH23

KORPUS

plyta melaminowana 18mm

FRONT

plyta melaminowana 18mm
uniwersalny L/P bez zamka

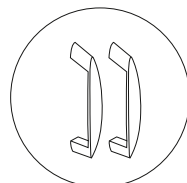
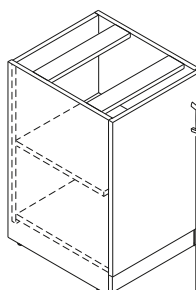

KH26



KORPUS

plyta melaminowana 18mm

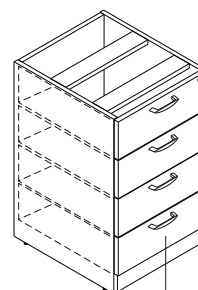

FRONT

plyta melaminowana 18mm
zamek centralny



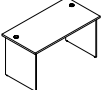

WIDOK i RZUT OBIEKTU	WYMIARY [mm]			SYMBOL	CENA NETTO PLN				UWAGI
	SZEROKOŚĆ	GLĘBOKOŚĆ	WYSOKOŚĆ			kg	m3	szt	

BIURKA PROSTE

	1160	700	758	BH071	250,-	29.7	0.073	3	
	1370	700	758	BH073	275,-	32.9	0.081	3	
	1600	700	758	BH076	295,-	37.2	0.088	3	

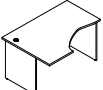
BIURKA KSZTAŁTOWE

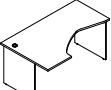

	1370	1000	758	BH025	395,-	35.8	0.102	3	
	1370	1000	758	BH026	395,-	36.4	0.109	3	
	1600	1000	758	BH047	430,-	42.0	0.113	3	
	1600	1000	758	BH048	430,-	42.3	0.113	3	

LEGENDA:



 - WAGA NETTO

 - OBJĘTOŚĆ





 - ILOŚĆ PACZEK

WIDOK i RZUT OBIEKTU	WYMIARY [mm]			SYMBOL	CENA NETTO PLN				UWAGI
	SZEROKOŚĆ	GLĘBOKOŚĆ	WYSOKOŚĆ			kg	m3	szt	

BIURKA PROSTE

	1160	700	758	BM071	335,-	27.7	0.081	3	
	1370	700	758	BM073	365,-	30.9	0.088	3	
	1600	700	758	BM076	390,-	35.1	0.096	3	

BIURKA KSZTAŁTOWE

	1370	1000	758	BM025	490,-	33.7	0.109	3	
	1370	1000	758	BM026	490,-	34.4	0.116	3	
	1600	1000	758	BM047	510,-	39.9	0.121	3	
	1600	1000	758	BM048	510,-	40.3	0.121	3	

AKCESORIA



	682	50	30	BM01	40,-	0.5	0.004	1	kanal kablowy KPL (2szt)
---	-----	----	----	-------------	------	-----	-------	---	--------------------------

LEGENDA:



 - WAGA NETTO

 - OBJĘTOŚĆ



 - ILOŚĆ PACZEK

WIDOK i RZUT OBIEKTU	WYMIARY [mm]			SYMBOL	CENA NETTO PLN				UWAGI
	SZEROKOŚĆ	GLĘBOKOŚĆ	WYSOKOŚĆ			kg	m3	szt	

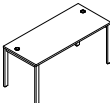
BIURKA PROSTE

	1160	700	758	BG071	400,-	28.1	0.087	4	
	1370	700	758	BG073	420,-	32.1	0.092	4	
	1600	700	758	BG076	440,-	35.1	0.098	4	

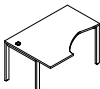
BIURKA KSZTAŁTOWE

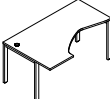

	1370	1000	758	BG025	540,-	34.1	0.107	4	
	1370	1000	758	BG026	540,-	34.1	0.107	4	
	1600	1000	758	BG047	560,-	39.1	0.118	4	
	1600	1000	758	BG048	560,-	39.1	0.118	4	

LEGENDA:

 - WAGA NETTO

 - OBJĘTOŚĆ

 - ILOŚĆ PACZEK

WIDOK i RZUT OBIEKTU	WYMIARY [mm]			SYMBOL	CENA NETTO PLN				UWAGI
	SZEROKOŚĆ	GLĘBOKOŚĆ	WYSOKOŚĆ			kg	m3	szt	

UKŁADY WIELOSTANOWISKOWE

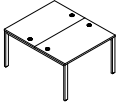
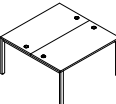
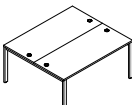
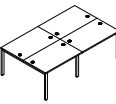
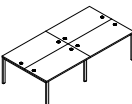
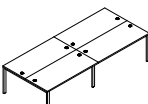
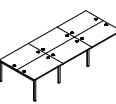
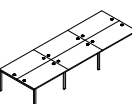
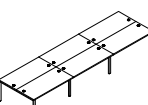

	1160	1400	758	BG021	800,-	51.5	0.258	8	układ dwustanowiskowy
	1370	1400	758	BG023	840,-	54.9	0.267	8	układ dwustanowiskowy
	1600	1400	758	BG024	880,-	62.8	0.269	8	układ dwustanowiskowy
	2320	1400	758	BG041	1 600,-	95.5	0.412	15	układ czterostanowiskowy
	2740	1400	758	BG043	1 680,-	102.3	0.430	15	układ czterostanowiskowy
	3200	1400	758	BG044	1 760,-	118.1	0.435	15	układ czterostanowiskowy
	3480	1400	758	BG061	2 400,-	139.5	0.566	22	układ szesciostanowiskowy
	4110	1400	758	BG063	2 520,-	149.7	0.594	22	układ szesciostanowiskowy
	4800	1400	758	BG064	2 640,-	173.4	0.601	22	układ szesciostanowiskowy

LEGENDA:

 - WAGA NETTO

 - OBJĘTOŚĆ

 - ILOŚĆ PACZEK

WIDOK i RZUT OBIEKTU	WYMIARY [mm]			SYMBOL	CENA NETTO PLN				UWAGI
	SZEROKOŚĆ	GLĘBOKOŚĆ	WYSOKOŚĆ			kg	m3	szt	

ELEMENTY DO ROZBUDOWY UKŁADÓW

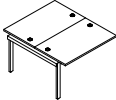
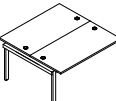
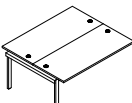
	1160	1400	758	BG011	700,-	44.0	0.154	7	element do rozbudowy układów
	1370	1400	758	BG013	800,-	47.4	0.164	7	element do rozbudowy układów
	1600	1400	758	BG014	840,-	55.3	0.166	7	element do rozbudowy układów

LEGENDA:

 - WAGA NETTO

 - OBJĘTOŚĆ

 - ILOŚĆ PACZEK

WIDOK i RZUT OBIEKTU	WYMIARY [mm]			SYMBOL	CENA NETTO PLN				UWAGI
	SZEROKOŚĆ	GLĘBOKOŚĆ	WYSOKOŚĆ			kg	m3	szt	

STOŁY KONFERENCYJNE

	1370	1400	758	BG123	820,-	90.4	0.319	7	
	1600	1400	758	BG124	860,-	102.4	0.343	7	
	2740	1400	758	BG143	1 660,-	173.3	0.535	13	
	3200	1400	758	BG144	1 740,-	197.3	0.582	13	
	1370	1400	758	BG113	780,-	82.9	0.216	6	element do rozbudowy układów
	1600	1400	758	BG114	820,-	94.9	0.240	6	element do rozbudowy układów

DODATKOWA DOPLATA DO CECHY



CECHA	SYMBOL										UWAGI
	BG123	BG124	BG143	BG144	BG113	BG114	kg	m3	szt		
TOP ACCESS M05	150,-	150,-	300,-	300,-	150,-	150,-	0.9	0.0070	1		

LEGENDA:







- WAGA NETTO

- OBJĘTOŚĆ

- ILOŚĆ PACZEK

WIDOK i RZUT OBIEKTU	WYMIARY [mm]			SYMBOL	CENA NETTO PLN				UWAGI
	SZEROKOŚĆ	GLĘBOKOŚĆ	WYSOKOŚĆ			kg	m3	szt	

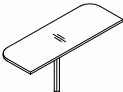
PRZYSTAWKI DO BIUREK

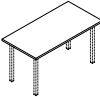
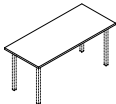
	700	700	28	PH77	130,-	12.5	0.018	1	
	500	500	28	TH10	60,-	5.3	0.011	1	
	500	700	28	TH09	70,-	7.3	0.015	1	
	500	900	28	TH11	85,-	8.5	0.018	1	
	1400	500	758	PH71	220,-	14.0	0.043	2	
	400	700	758	PH72	140,-	7.7	0.029	2	
	700	700	28	TH12	75,-	9.0	0.019	1	w cenę nie wliczono nóg podpierających (4szt.)
	1370	700	28	TH15	120,-	17.2	0.038	1	w cenę nie wliczono nóg podpierających (4szt.)
	1600	700	28	TH14	130,-	22.0	0.041	1	w cenę nie wliczono nóg podpierających (4szt.)

NOGI PODPIERAJĄCE

	40	40	730	NH44	65,-	2.0	0.017	1	noga kwadratowa
---	----	----	-----	------	------	-----	-------	---	-----------------

OSŁONY PRZEDNIE DO BIUREK - RASTROWE

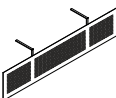

	1400	15	300	CUR15	286,-	3.1	0.009	1	
---	------	----	-----	-------	-------	-----	-------	---	--

LEGENDA:

 - WAGA NETTO

 - OBJĘTOŚĆ

 - ILOŚĆ PACZEK

WIDOK i RZUT OBIEKTU	WYMIARY [mm]			SYMBOL	CENA NETTO PLN				UWAGI
	SZEROKOŚĆ	GLĘBOKOŚĆ	WYSOKOŚĆ			kg	m3	szt	

PANELE PŁYTOWE

	650	18	350	RH070	110,-	3.0	0.016	1	
	900	18	350	RH090	145,-	4.0	0.022	1	
	1300	18	350	RH130	165,-	6.8	0.041	1	

PANELE PŁYTOWE Z PODUSZKAMI TKANINOWYMI



	650	45	350	RH070P	350,-	9.0	0.016	1	
	900	45	350	RH090P	390,-	12.0	0.022	1	
	1300	45	350	RH130P	435,-	17.0	0.032	1	

LEGENDA:











 - WAGA NETTO

 - OBJĘTOŚĆ

 - ILOŚĆ PACZEK

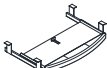
WIDOK i RZUT OBIEKTU	WYMIARY [mm]			SYMBOL	CENA NETTO PLN				UWAGI
	SZEROKOŚĆ	GLĘBOKOŚĆ	WYSOKOŚĆ			kg	m3	szt	

AKCESORIA



	140	70	750	S81SI	125,-	1.1	0.008	1	
	1000	70	35	S82SI	65,-	1.0	0.005	1	
	212	460	617	S83SI	130,-	2.7	0.027	1	kolor: 09 - aluminium
				AK3SI	30,-	0.2	0.000	1	
	470	220	148	S73SI	140,-	3.2	0.002	1	kolor: 84 - popiel
	470	256	146	CH11	80,-	2.5	0.012	1	kolor: 84 - popiel
	362	167	23	CH21	30,-	0.5	0.003	1	piórnik nakładany, czarny
	610	400	85	C01SI	125,-	0.5	0.010	1	półka pod klawiaturę - tworzywo szare
	560	372	110	CH01	80,-	4.9	0.028	1	półka pod klawiaturę, kolor: 84 - popiel
	300			S86SI	15,-	0.2	0.002	1	wieszak wysuwny w kolorze chrom
	580	162	123	S69SI	75,-	1.0	0.015	1	kolor: 09 - aluminium

LEGENDA:

 - WAGA NETTO

 - OBJĘTOŚĆ

 - ILOŚĆ PACZEK

WIDOK i RZUT OBIEKTU	WYMIARY [mm]			SYMBOL	CENA NETTO PLN				UWAGI
	SZEROKOŚĆ	GLĘBOKOŚĆ	WYSOKOŚĆ			kg	m3	szt	

AKCESORIA

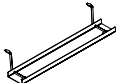







	460	110	121	E64	65,-	0.0	0.000	0	kanal kablowy 09-aluminium
---	-----	-----	-----	------------	------	-----	-------	---	----------------------------

LEGENDA:

 - WAGA NETTO

 - OBJĘTOŚĆ

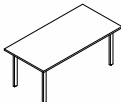
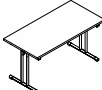
 - ILOŚĆ PACZEK

WIDOK i RZUT OBIEKTU	WYMIARY [mm]			SYMBOL	CENA NETTO PLN				UWAGI
	SZEROKOŚĆ	GLĘBOKOŚĆ	WYSOKOŚĆ			kg	m3	szt	
	630	630	650	PH62	225,-	15.0	0.035	1	
	630	630	650	PH64	215,-	17.0	0.037	1	
	1370	700	758	PH53	285,-	31.6	0.073	1	
	1800	900	758	PH56	580,-	44.7	0.111	3	
	1390	695	725	PSC07	590,-	23.0	0.112	2	stół składany - stelaż w kolorze chrom
	800	800	730	CST08	790,-	21.0	0.218	2	

LEGENDA:

 - WAGA NETTO

 - OBJĘTOŚĆ

 - ILOŚĆ PACZEK



WIDOK i RZUT OBIEKTU	WYMIARY [mm]			SYMBOL	CENA NETTO PLN				UWAGI
	SZEROKOŚĆ	GLĘBOKOŚĆ	WYSOKOŚĆ			kg	m3	szt	

KONTENERY

	435	525	590	KH13	370,-	24.9	0.114	1	
	428	495	730	KH23	230,-	19.3	0.044	1	
	428	495	730	KH26	420,-	24.3	0.180	1	

LEGENDA:

- WAGA NETTO

- OBJĘTOŚĆ

- ILOŚĆ PACZEK



WIDOK i RZUT OBIEKTU	WYMIARY [mm]			SYMBOL	CENA NETTO PLN					UWAGI
	SZEROKOŚĆ	GLĘBOKOŚĆ	WYSOKOŚĆ			kg	m3	szt		

SZAFY I REGAŁY

	802	385	2185	H61	620,-	67.4	0.137	3		
	602	385	1833	H62	410,-	41.0	0.132	3		- szafa ubraniowa bez zamka
	602	385	1833	H65	295,-	32.9	0.095	2		
	802	802	1833	H05	620,-	68.0	0.213	2		
	802	385	1833	H51	490,-	56.6	0.137	3		
	802	385	1833	H52	580,-	56.1	0.133	3		- szafa ubraniowo-aktowa, bez zamka
	802	385	1833	H54	420,-	47.0	0.116	3		
	802	385	1833	H55	330,-	40.1	0.096	2		
	802	385	1129	H31	380,-	36.6	0.088	3		
	802	385	1129	H34	340,-	31.8	0.083	3		
	802	385	1129	H35	240,-	24.9	0.063	2		

LEGENDA:

- WAGA NETTO

- OBJĘTOŚĆ

- ILOŚĆ PACZEK



WIDOK i RZUT OBIEKTU	WYMIARY [mm]			SYMBOL	CENA NETTO PLN					UWAGI
	SZEROKOŚĆ	GLĘBOKOŚĆ	WYSOKOŚĆ			kg	m3	szt		

SZAFY UNIWERSALNE

	802	385	777	H11	320,-	25.9	0.065	3		do zastosowania jako nadstawka, dostawka do biuka lub szafa wolnostojąca
	802	385	777	H12	210,-	19.0	0.044	2		do zastosowania jako nadstawka, dostawka do biuka lub szafa wolnostojąca
	602	385	777	H10	195,-	17.6	0.045	2		do zastosowania jako nadstawka, dostawka do biuka lub szafa wolnostojąca

SZAFĄ ŻALUZJOWA

	1200	385	1129	SK3Z06	1 250,-	64.0	0.600	1		cała w kolorze 84- popiel
--	------	-----	------	--------	---------	------	-------	---	--	---------------------------

ELEMENTY DODATKOWE

	710	600	600	S85SI	290,-	32.0	0.066	1		szafka pod ksero, cała w kolorze 84-popiel
	350	385	370	SH351	120,-	6.0	0.016	1		organizer - cały w kolorze 84-popiel

LEGENDA:

- WAGA NETTO

- OBJĘTOŚĆ

- ILOŚĆ PACZEK



WIDOK I RZUT OBIEKTU	WYMIARY [mm]			SYMBOL	CENA NETTO PLN					UWAGI
	SZEROKOŚĆ	GLĘBOKOŚĆ	WYSOKOŚĆ			kg	m3	szt		

ELEMENTY DODATKOWE DO SZAF

	796	18	1754	H51D	175,-	16.5	0.042	1		
	596	18	1754	H62D	125,-	14.3	0.059	1		drzwi uniwersalne(lewe i prawe) bez zamka
	796	18	1050	H31D	150,-	11.8	0.025	1		
	796	18	699	H11D	125,-	6.9	0.020	1		
	596	18	699	H10D	100,-	5.0	0.026	1		drzwi uniwersalne(lewe i prawe) bez zamka
	796	5	1050	HS23	230,-	11.0	0.040	1		drzwi szklane(2szt.)3OH, szkło hartowane bezbarwne, bez zamka
	794	20	1050	HS300	640,-	10.3	0.037	1		drzwi szklane(2szt.)3OH z ramka aluminiowa, uniwersalne, szkło hartowane mleczne, bez zamka

LEGENDA:

- WAGA NETTO

- OBJĘTOŚĆ

- ILOŚĆ PACZEK

► **SVENBOX INVEST**

ELEMENTY PŁYTOWE



14 - BUK



78 -

**BIURKA /
PRZYSTAWKI**
- blat

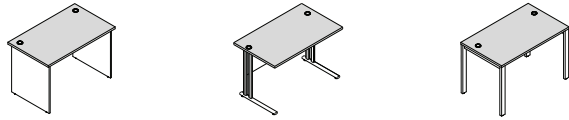

**SZAFY /
KONTENERY**
- front płytowy
- wieniec górny
- wieniec dolny



**UKŁADY WIELOSTANOWISKOWE /
STÓŁY KONFERENCYJNE /
STOLIKI**
- blat

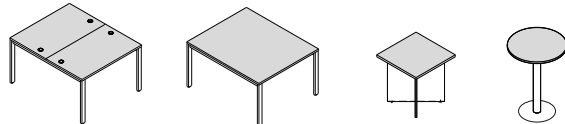

ELEMENTY PŁYTOWE



84-POPIEL

BIURKA
- nogi płytowe
- osłony płytowe

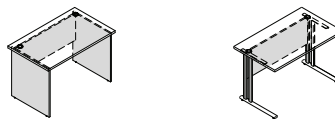

**SZAFY /
KONTENERY**
- korpus

SZAFKA ŻALUZJOWA
- wieniec górny
- wieniec dolny
- korpus

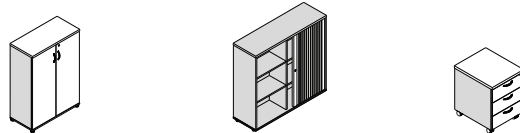

**STÓŁY KONFERENCYJNE /
STOLIKI**
- nogi płytowe
- blenda płytowa

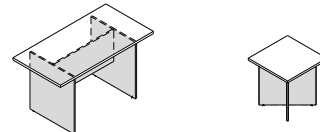

PANELE PŁYTOWE
ELEMENTY DODATKOWE

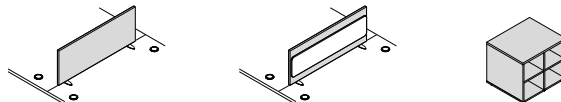

ELEMENTY METALOWE



09 - ALUMINIUM

**BIURKA /
PRZYSTAWKI**
- stelaż metalowy
- noga podpierająca

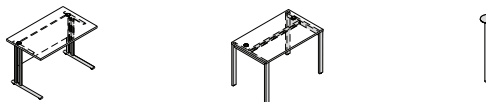

UKŁADY WIELOSTANOWISKOWE
STÓŁY KONFERENCYJNE
(bez stołu PSC06)

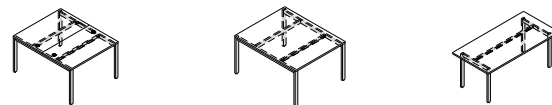

OSŁONA RASTROWA

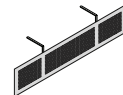

09 - ALUMINIUM



15 - BIAŁY POŁYSK

STELAŻ



► SVENBOX INVEST

ELEMENTY TKANINOWE

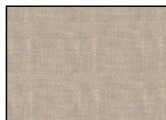

NX2 - BEŻOWY



NX3 - POMARAŃCZ



NX5 - CZERWONY

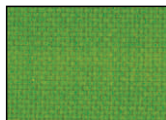

NX9 - ZIELONY



Nx10 - SZARY



NX15-GRANATOWY

PODUSZKA TKANINOWA

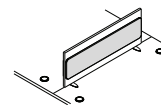

1. BIURKA

1.1 BLAT

kolor - 14 buk : płyta melaminowana 28mm, obrzeże PVC 2mm

kolor - 78 klon jersey : płyta melaminowana 25mm, obrzeże PVC 2mm

STANDARD - blat z przelotami kablowymi $\varnothing 60$

biurka proste

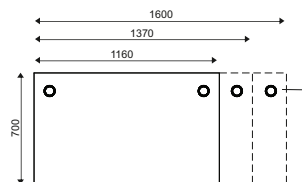

przelot kablowy $\varnothing 60$
kolor: 09 ALUMINIUM

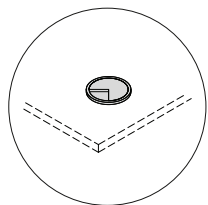

biurka kształtowe

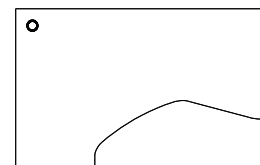
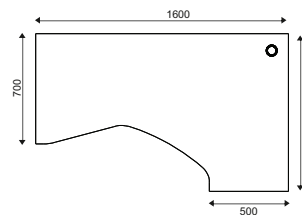
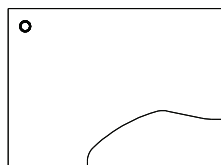
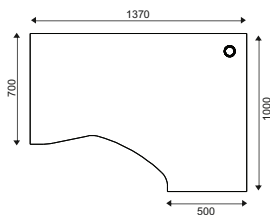

1.2 PODSTAWA

EKO_I

nogi płytowe - płyta melaminowana 18mm
blenda - płyta melaminowana 18mm

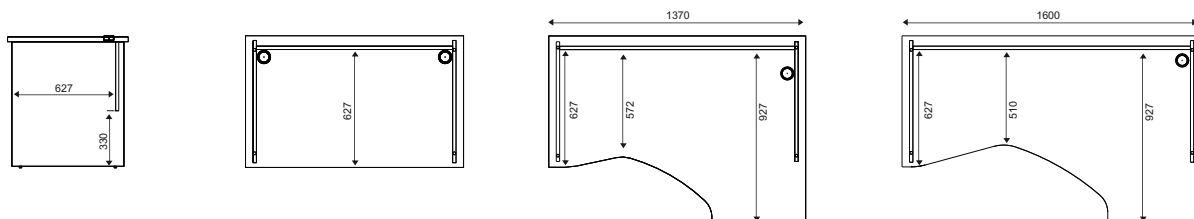
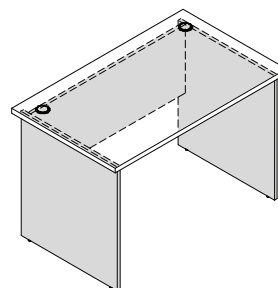

VIK_I

nogi metalowe - metal malowany proszkowo
blenda - płyta melaminowana 18mm

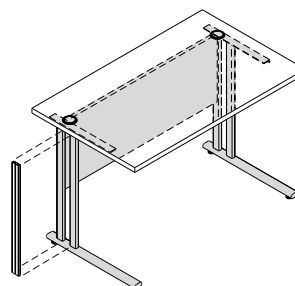

ELEMENT DODATKOWY
 kanał kablowy BM01 (2 szt.)

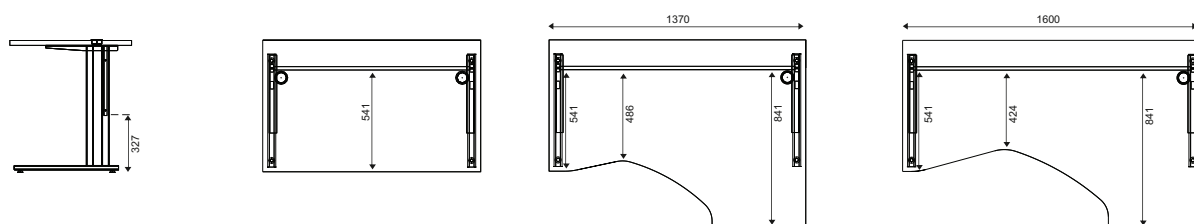

ART_I

stelaż - metal malowany proszkowo
 profil 30x60

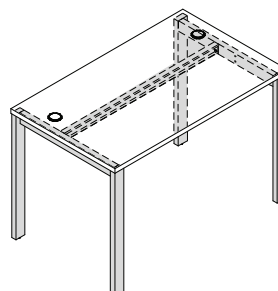

2. UKŁADY WIELOSTANOWISKOWE

2.1 BLAT

kolor - 14 buk : płyta melaminowana 28mm, obrzeże PVC 2mm
kolor - 78 klon jersey : płyta melaminowana 25mm, obrzeże PVC 2mm

STANDARD

blat z przelotami kablowymi $\varnothing 60$

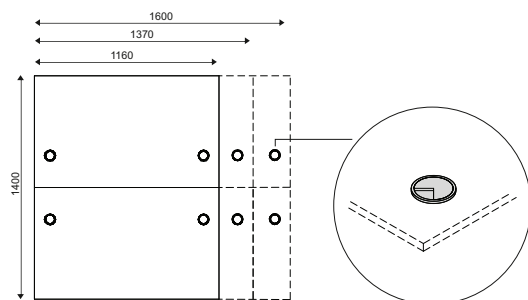

2.2 STELAŻ

metal malowany proszkowo
profil 30x60

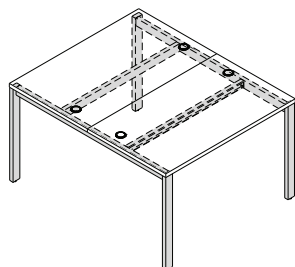

2.3 TWORZENIE UKŁADÓW WIELOSTANOWISKOWYCH

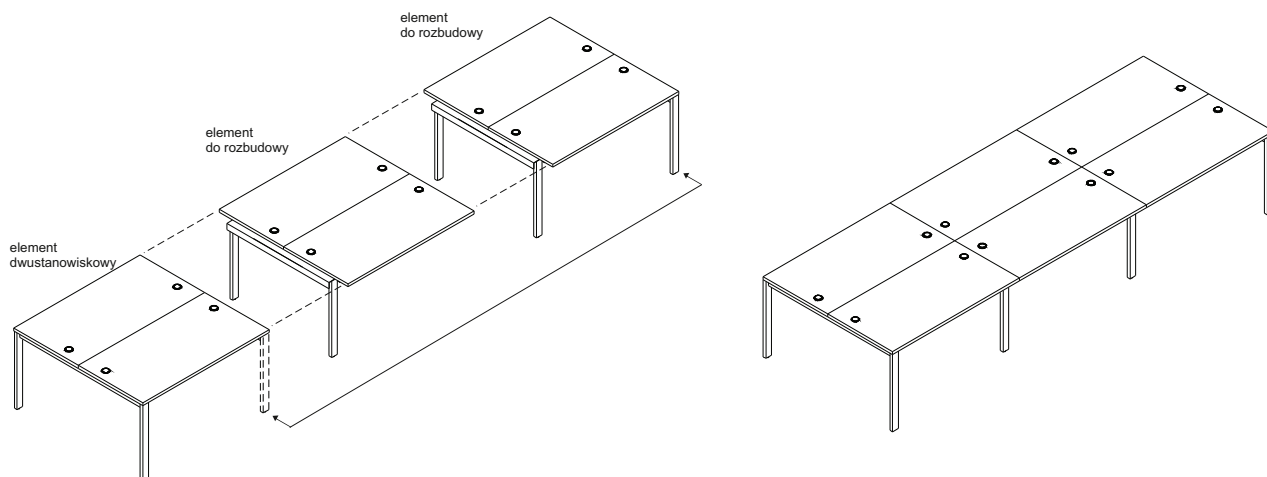

3. STOŁY KONFERENCYJNE

3.1 BLAT

kolor - 14 buk : płyta melaminowana 28mm, obrzeże PVC 2mm
kolor - 78 klon jersey : płyta melaminowana 25mm, obrzeże PVC 2mm

STANDARD

blat prosty

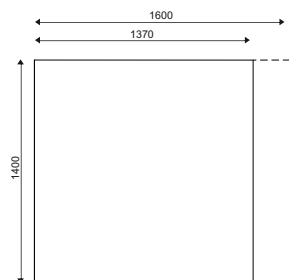

OPCJA

blat prosty TOP ACCESS M05

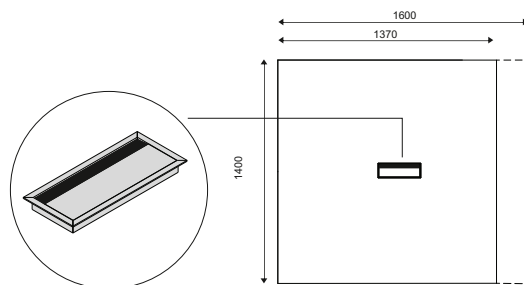

3.2 STELAŻ

metal malowany proszkowo
profil 30x60

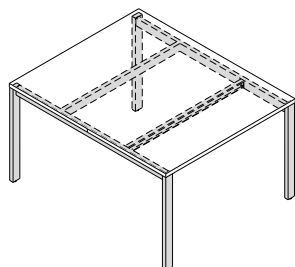

3.3 ROZBUDOWA STOŁU KONFERENCYJNEGO

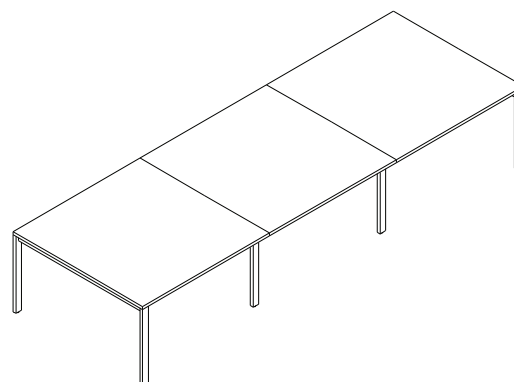
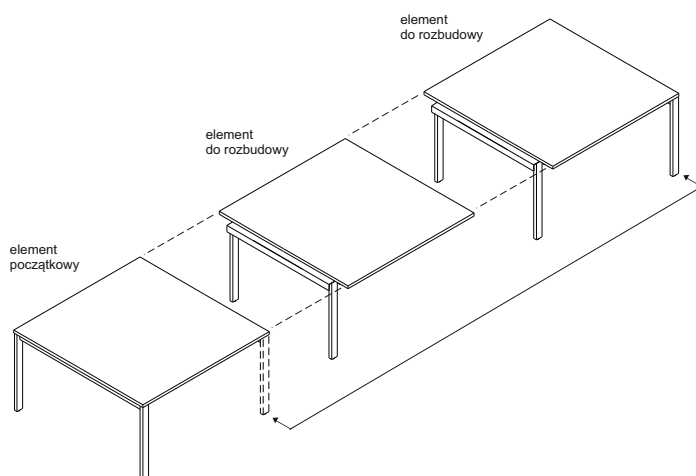

4. PANELE DO UKŁADÓW WIELOSTANOWISKORZYCH

PANELE PŁYTOWE

plyta melaminowana 18mm

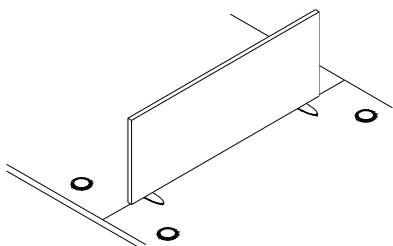

PANELE PŁYTOWE

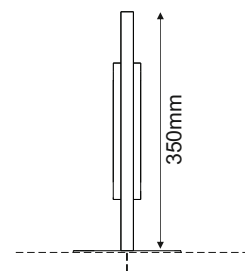
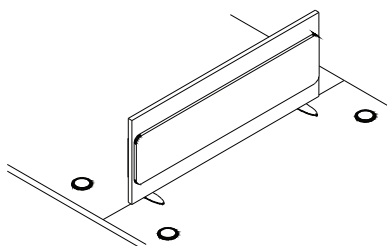
Z PODUSZKAMI TKANINOWYMI
plyta melaminowana 18mm

5. PRZYSTAWKI

5.1 BLAT

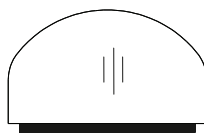
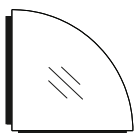

kolor - 14 buk : płyta melaminowana 28mm, obrzeże PVC 2mm

kolor - 78 klon jersey : płyta melaminowana 25mm, obrzeże PVC 2mm

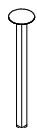

5.2 NOGA PODPIERAJĄCA

metal malowany proszkowo

 profil 40x40 mm

6. STOŁY KONFERENCYJNE

6.1 BLAT

kolor - 14 buk : płyta melaminowana 28mm, obrzeże PVC 2mm
kolor - 78 klon jersey : płyta melaminowana 25mm, obrzeże PVC 2mm

6.1 STELAŻ

VPSC07 stół składany

stelaż - chrom

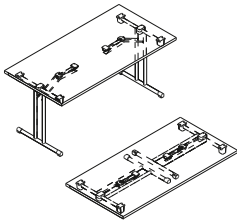
**VST08**

blat - ø800
talerz - stal nierdzewna, ø500
kolumna - metal malowany proszkowo, ø60

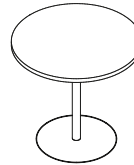
**VPH62 VPH64**

podstawa - płyta melaminowana 18mm

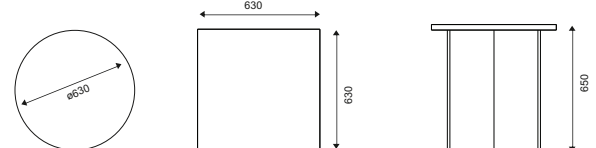
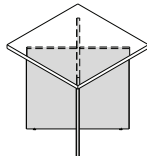
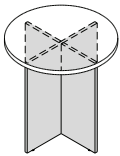
**VPH53**

podstawa - płyta melaminowana 18mm

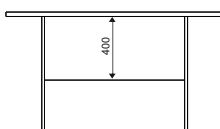
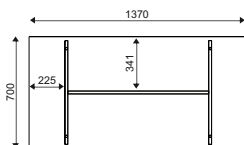
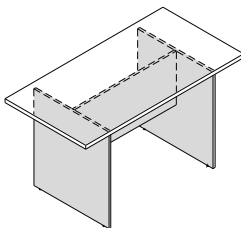
**VPH56**

stelaż - metal malowany proszkowo
profil - 30x60 mm

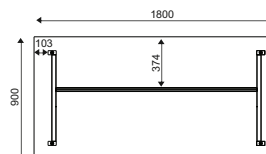
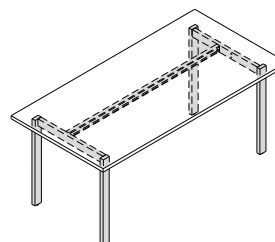

7. SZAFY I REGAŁY

7.1 WIENIEC GÓRNY

kolor - 14 buk : płyta melaminowana 28mm, obrzeże PVC 2mm
 kolor - 78 klon jersey : płyta melaminowana 25mm, obrzeże PVC 2mm

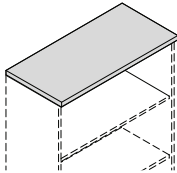

7.2 KORPUS

płyta melaminowana 18mm

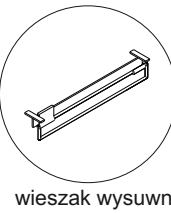
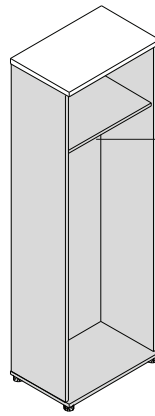
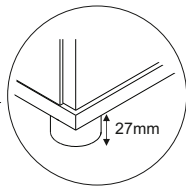
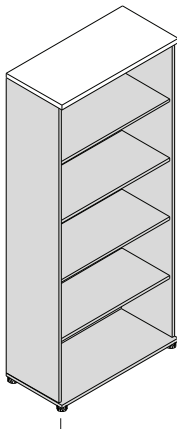

wieszak wysuwny

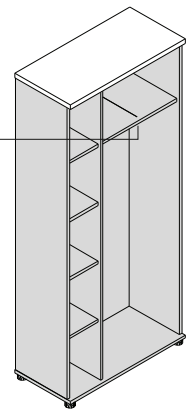

VH62
szafa ubraniowa bez zamka

Vh52
szafa ubraniowo-aktowa
bez zamka

7.3 FRONT DO SZAF I REGAŁÓW

drzwi płytowe
 - płyta melaminowana 18mm
 - zamek patentowy

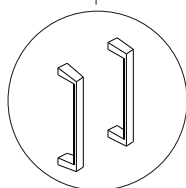
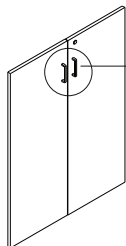

drzwi szklane(2szt.) 3OH,
 - szkło hartowane bezbarwne
 - bez zamka

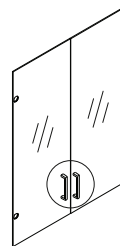

drzwi szklane(2szt.) 3OH
 - ramka aluminiowa
 - szkło hartowane mleczne
 - bez zamka

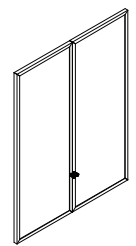

8. SZAFKA ŻALUZYJOWA

WIENIEC GÓRNY

plyta melaminowana 28mm,
obrzeże PVC 2mm

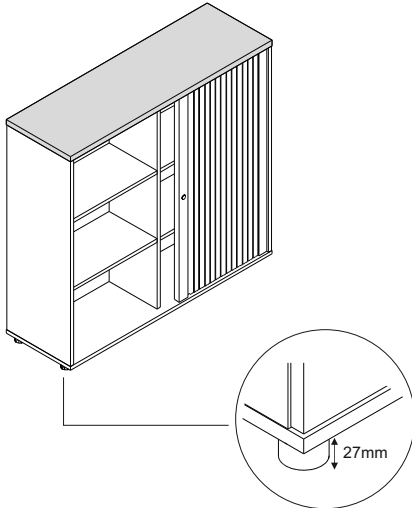
**KORPUS**

plyta melaminowana 18mm,
obrzeże PVC 2mm

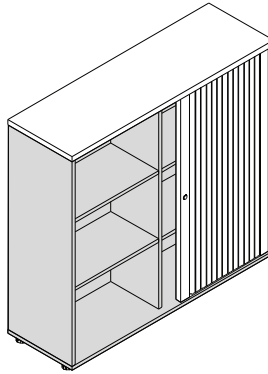
**FRONT**

żaluzja 09 - aluminium

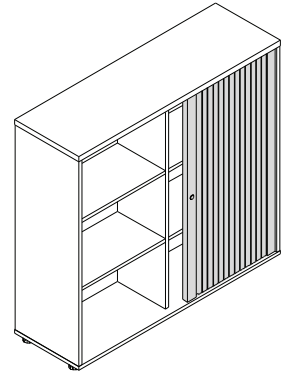

9. KONTENERY

VKH13**WIENIEC GÓRNY**

kolor - 14 buk :
plyta melaminowana 28mm,
obrzeże PVC 2mm

kolor - 78 klon jersey :
plyta melaminowana 25mm,
obrzeże PVC 2mm

KORPUS

plyta melaminowana 18mm

FRONT

plyta melaminowana 18mm
zamek centralny

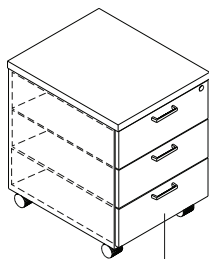
**VKH23****KORPUS**

plyta melaminowana 18mm

FRONT

plyta melaminowana 18mm
uniwersalny L/P bez zamka

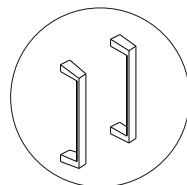
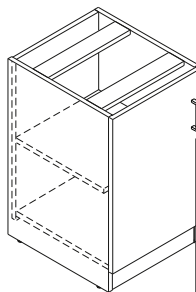

**VKH26****KORPUS**

plyta melaminowana 18mm

FRONT

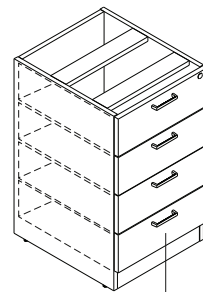
plyta melaminowana 18mm
zamek centralny



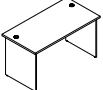
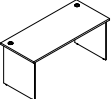

WIDOK i RZUT OBIEKTU	WYMIARY [mm]			SYMBOL	CENA NETTO PLN				UWAGI
	SZEROKOŚĆ	GLĘBOKOŚĆ	WYSOKOŚĆ			kg	m3	szt	

BIURKA PROSTE

	1160	700	758	VBH071	265,-	30.2	0.070	4	
	1370	700	758	VBH073	290,-	34.2	0.078	4	
	1600	700	758	VBH076	310,-	37.7	0.086	4	

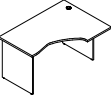
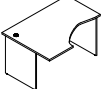
BIURKA KSZTAŁTOWE

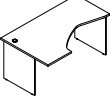

	1370	1000	758	VBH025	415,-	36.2	0.092	4	
	1370	1000	758	VBH026	415,-	36.2	0.092	4	
	1600	1000	758	VBH047	450,-	41.7	0.105	4	
	1600	1000	758	VBH048	450,-	41.7	0.105	4	

LEGENDA:

 - WAGA NETTO

 - OBJĘTOŚĆ

 - ILOŚĆ PACZEK

WIDOK i RZUT OBIEKTU	WYMIARY [mm]			SYMBOL	CENA NETTO PLN				UWAGI
	SZEROKOŚĆ	GLĘBOKOŚĆ	WYSOKOŚĆ			kg	m3	szt	

BIURKA PROSTE

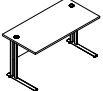
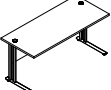
	1160	700	758	VBM071	350,-	27.9	0.075	3	
	1370	700	758	VBM073	385,-	31.9	0.083	3	
	1600	700	758	VBM076	410,-	35.4	0.091	3	

BIURKA KSZTAŁTOWE

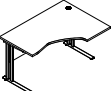
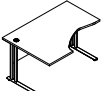
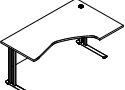
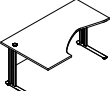
	1370	1000	758	VBM025	515,-	33.9	0.097	3	
	1370	1000	758	VBM026	515,-	33.9	0.097	3	
	1600	1000	758	VBM047	535,-	39.4	0.110	3	
	1600	1000	758	VBM048	535,-	39.4	0.110	3	

AKCESORIA



	682	50	30	BM01	40,-	0.5	0.004	1	kanal kablowy KPL (2szt)
---	-----	----	----	-------------	------	-----	-------	---	--------------------------

LEGENDA:



 - WAGA NETTO

 - OBJĘTOŚĆ



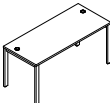

 - ILOŚĆ PACZEK

WIDOK i RZUT OBIEKTU	WYMIARY [mm]			SYMBOL	CENA NETTO PLN				UWAGI
	SZEROKOŚĆ	GLĘBOKOŚĆ	WYSOKOŚĆ			kg	m3	szt	

BIURKA PROSTE

	1160	700	758	VBG071	420,-	28.0	0.084	4	
	1370	700	758	VBG073	440,-	31.7	0.087	3	
	1600	700	758	VBG076	460,-	34.7	0.093	3	

BIURKA KSZTAŁTOWE



	1370	1000	758	VBG025	570,-	33.7	0.102	3	
	1370	1000	758	VBG026	570,-	33.7	0.102	3	
	1600	1000	758	VBG047	590,-	38.7	0.112	3	
	1600	1000	758	VBG048	590,-	39.0	0.115	4	

LEGENDA:

 - WAGA NETTO

 - OBJĘTOŚĆ

 - ILOŚĆ PACZEK

WIDOK i RZUT OBIEKTU	WYMIARY [mm]			SYMBOL	CENA NETTO PLN					UWAGI
	SZEROKOŚĆ	GLĘBOKOŚĆ	WYSOKOŚĆ			kg	m3	szt		

UKŁADY WIELOSTANOWISKOWE

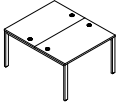
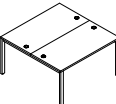
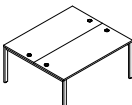
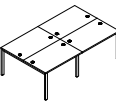
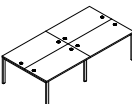
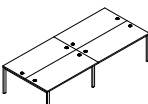
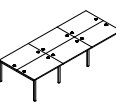
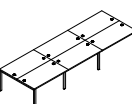
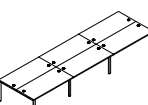

	1160	1400	758	VBG021	840,-	48.0	0.235	6		układ dwustanowiskowy
	1370	1400	758	VBG023	880,-	56.0	0.246	6		układ dwustanowiskowy
	1600	1400	758	VBG024	920,-	62.0	0.258	6		układ dwustanowiskowy
	2320	1400	758	VBG041	1 680,-	88.5	0.366	11		układ czterostanowiskowy
	2740	1400	758	VBG043	1 760,-	104.5	0.389	11		układ czterostanowiskowy
	3200	1400	758	VBG044	1 850,-	116.5	0.413	11		układ czterostanowiskowy
	3480	1400	758	VBG061	2 520,-	129.0	0.497	16		układ sześciostanowiskowy
	4110	1400	758	VBG063	2 650,-	153.0	0.531	16		układ sześciostanowiskowy
	4800	1400	758	VBG064	2 770,-	171.0	0.568	16		układ sześciostanowiskowy

LEGENDA:

 - WAGA NETTO

 - OBJĘTOŚĆ

 - ILOŚĆ PACZEK

WIDOK i RZUT OBIEKTU	WYMIARY [mm]			SYMBOL	CENA NETTO PLN				UWAGI
	SZEROKOŚĆ	GLĘBOKOŚĆ	WYSOKOŚĆ			kg	m3	szt	

ELEMENTY DO ROZBUDOWY UKŁADÓW

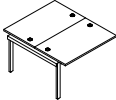
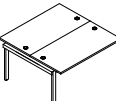
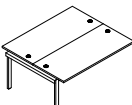

	1160	1400	758	VBG011	735,-	40.5	0.131	5	element do rozbudowy układów
	1370	1400	758	VBG013	840,-	48.5	0.143	5	element do rozbudowy układów
	1600	1400	758	VBG014	880,-	54.5	0.155	5	element do rozbudowy układów

LEGENDA:

 - WAGA NETTO

 - OBJĘTOŚĆ



 - ILOŚĆ PACZEK

WIDOK i RZUT OBIEKTU	WYMIARY [mm]			SYMBOL	CENA NETTO PLN				UWAGI
	SZEROKOŚĆ	GLĘBOKOŚĆ	WYSOKOŚĆ			kg	m3	szt	

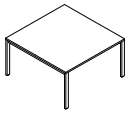
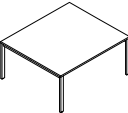
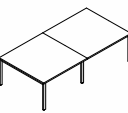
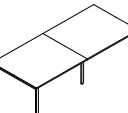
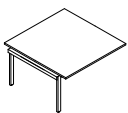
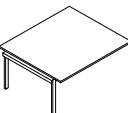
STOŁY KONFERENCYJNE

	1370	1400	758	VBG123	860,-	55.0	0.245	5	
	1600	1400	758	VBG124	900,-	62.0	0.257	5	
	2740	1400	758	VBG143	1 740,-	102.5	0.387	9	
	3200	1400	758	VBG144	1 830,-	116.5	0.411	9	
	1370	1400	758	VBG113	820,-	47.5	0.142	4	element do rozbudowy układów
	1600	1400	758	VBG114	860,-	54.5	0.154	4	element do rozbudowy układów

DODATKOWA DOPLATA DO CECHY



CECHA	SYMBOL										UWAGI
	VBG123	VBG124	VBG143	VBG144	VBG113	VBG114		kg	m3	szt	
TOP ACCESS M05	150,-	150,-	300,-	300,-	150,-	150,-		0.9	0.0070	1	

LEGENDA:









 - WAGA NETTO

 - OBJĘTOŚĆ

 - ILOŚĆ PACZEK

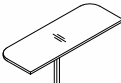
WIDOK i RZUT OBIEKTU	WYMIARY [mm]			SYMBOL	CENA NETTO PLN				UWAGI
	SZEROKOŚĆ	GLĘBOKOŚĆ	WYSOKOŚĆ			kg	m3	szt	

PRZYSTAWKI DO BIUREK

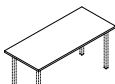
	700	700	28	VPH77	140,-	12.5	0.018	1	
	500	500	28	VTH10	65,-	5.3	0.011	1	
	500	700	28	VTH09	75,-	7.3	0.015	1	
	500	900	28	VTH11	90,-	8.5	0.018	1	
	1400	500	758	VPH71	230,-	14.0	0.043	2	
	400	700	758	VPH72	150,-	7.7	0.029	2	
	700	700	28	VTH12	80,-	9.0	0.019	1	w cenę nie wliczono nóg podpierających (4szt.)
	1370	700	28	VTH15	130,-	17.2	0.038	1	w cenę nie wliczono nóg podpierających (4szt.)
	1600	700	28	VTH14	140,-	22.0	0.041	1	w cenę nie wliczono nóg podpierających (4szt.)

NOGI PODPIERAJĄCE

	40	40	730	NH44	65,-	2.0	0.017	1	noga kwadratowa
---	----	----	-----	-------------	------	-----	-------	---	-----------------

OSŁONY PRZEDNIE DO BIUREK - RASTROWE

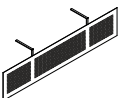

	1400	15	300	CUR15	286,-	3.1	0.009	1	
---	------	----	-----	--------------	-------	-----	-------	---	--

LEGENDA:

 - WAGA NETTO

 - OBJĘTOŚĆ

 - ILOŚĆ PACZEK

WIDOK i RZUT OBIEKTU	WYMIARY [mm]			SYMBOL	CENA NETTO PLN				UWAGI
	SZEROKOŚĆ	GLĘBOKOŚĆ	WYSOKOŚĆ			kg	m3	szt	

PANELE PŁYTOWE

	650	18	350	RH070	110,-	3.0	0.016	1	
	900	18	350	RH090	145,-	4.0	0.022	1	
	1300	18	350	RH130	165,-	6.8	0.041	1	

PANELE PŁYTOWE Z PODUSZKAMI TKANINOWYMI



	650	45	350	RH070P	350,-	9.0	0.016	1	
	900	45	350	RH090P	390,-	12.0	0.022	1	
	1300	45	350	RH130P	435,-	17.0	0.032	1	

LEGENDA:











 - WAGA NETTO

 - OBJĘTOŚĆ

 - ILOŚĆ PACZEK

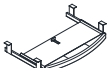
WIDOK i RZUT OBIEKTU	WYMIARY [mm]			SYMBOL	CENA NETTO PLN				UWAGI
	SZEROKOŚĆ	GLĘBOKOŚĆ	WYSOKOŚĆ			kg	m3	szt	

AKCESORIA



	140	70	750	S81SI	125,-	1.1	0.008	1	
	1000	70	35	S82SI	65,-	1.0	0.005	1	
	212	460	617	S83SI	130,-	2.7	0.027	1	kolor: 09 - aluminium
				AK3SI	30,-	0.2	0.000	1	
	470	220	148	S73SI	140,-	3.2	0.002	1	kolor: 84 - popiel
	470	256	146	CH11	80,-	2.5	0.012	1	kolor: 84 - popiel
	362	167	23	CH21	30,-	0.5	0.003	1	piórnik nakładany, czarny
	610	400	85	C01SI	125,-	0.5	0.010	1	półka pod klawiaturę - tworzywo szare
	560	372	110	CH01	80,-	4.9	0.028	1	półka pod klawiaturę, kolor: 84 - popiel
	300			S86SI	15,-	0.2	0.002	1	wieszak wysuwny w kolorze chrom
	580	162	123	S69SI	75,-	1.0	0.015	1	kolor: 09 - aluminium

LEGENDA:

 - WAGA NETTO

 - OBJĘTOŚĆ

 - ILOŚĆ PACZEK

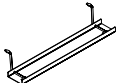







WIDOK i RZUT OBIEKTU	WYMIARY [mm]			SYMBOL	CENA NETTO PLN				UWAGI
	SZEROKOŚĆ	GLĘBOKOŚĆ	WYSOKOŚĆ			kg	m3	szt	
AKCESORIA									
	460	110	121	E64	65,-	0.0	0.000	0	kanal kablowy 09-aluminium

LEGENDA:

 - WAGA NETTO

 - OBJĘTOŚĆ

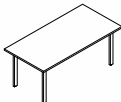
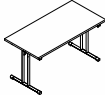
 - ILOŚĆ PACZEK

WIDOK i RZUT OBIEKTU	WYMIARY [mm]			SYMBOL	CENA NETTO PLN				UWAGI
	SZEROKOŚĆ	GLĘBOKOŚĆ	WYSOKOŚĆ			kg	m3	szt	
	630	630	650	VPH62	235,-	15.0	0.035	1	
	630	630	650	VPH64	225,-	17.0	0.037	1	
	1370	700	758	VPH53	300,-	31.6	0.073	1	
	1800	900	758	VPH56	610,-	44.7	0.111	3	
	1390	695	725	VPSC07	620,-	23.0	0.112	2	stół składany - stelaż w kolorze chrom
	800	800	730	VST08	830,-	21.0	0.218	2	

LEGENDA:

 - WAGA NETTO

 - OBJĘTOŚĆ

 - ILOŚĆ PACZEK



WIDOK i RZUT OBIEKTU	WYMIARY [mm]			SYMBOL	CENA NETTO PLN					UWAGI
	SZEROKOŚĆ	GLĘBOKOŚĆ	WYSOKOŚĆ			kg	m3	szt		

KONTENERY

	435	525	590	VKH13	390,-	26.2	0.139	1		
	428	495	730	VKH23	240,-	19.3	0.044	1		
	428	495	730	VKH26	440,-	25.5	0.180	1		

LEGENDA:

- WAGA NETTO

- OBJĘTOŚĆ

- ILOŚĆ PACZEK



WIDOK I RZUT OBIEKTU	WYMIARY [mm]			SYMBOL	CENA NETTO PLN					UWAGI
	SZEROKOŚĆ	GLĘBOKOŚĆ	WYSOKOŚĆ			kg	m ³	szt		

SZAFY I REGAŁY

	802	385	2185	VH61	650,-	67.4	0.137	3		
	602	385	1833	VH62	430,-	39.8	0.132	3		- szafa ubraniowa bez zamka
	602	385	1833	VH65	310,-	32.9	0.095	2		
	802	802	1833	VH05	650,-	68.0	0.213	2		
	802	385	1833	VH51	515,-	57.9	0.133	3		
	802	385	1833	VH52	610,-	56.1	0.133	3		- szafa ubraniow-aktowa, bez zamka
	802	385	1833	VH54	440,-	47.7	0.112	3		
	802	385	1833	VH55	350,-	40.1	0.096	2		
	802	385	1129	VH31	400,-	34.9	0.088	3		
	802	385	1129	VH34	360,-	32.5	0.079	3		
	802	385	1129	VH35	250,-	24.9	0.063	2		

LEGENDA:

- WAGA NETTO

- OBJĘTOŚĆ

- ILOŚĆ PACZEK



WIDOK i RZUT OBIEKTU	WYMIARY [mm]			SYMBOL	CENA NETTO PLN					UWAGI
	SZEROKOŚĆ	GLĘBOKOŚĆ	WYSOKOŚĆ			kg	m3	szt		

SZAFY UNIWERSALNE

	802	385	777	VH11	340,-	26.7	0.061	3		
	802	385	777	VH12	220,-	19.0	0.044	2		
	602	385	777	VH10	205,-	17.6	0.045	2		

SZAFĄ ŻALUZJOWA

	1200	385	1129	SK3Z06	1 250,-	64.0	0.600	1		cała w kolorze 84- popiel
--	------	-----	------	--------	---------	------	-------	---	--	---------------------------

ELEMENTY DODATKOWE

	710	600	600	S85SI	290,-	32.0	0.066	1		szafka pod ksero, cała w kolorze 84-popiel
	350	385	370	SH351	120,-	6.0	0.016	1		organizer - cały w kolorze 84-popiel

LEGENDA:

- WAGA NETTO

- OBJĘTOŚĆ

- ILOŚĆ PACZEK



WIDOK I RZUT OBIEKTU	WYMIARY [mm]			SYMBOL	CENA NETTO PLN					UWAGI
	SZEROKOŚĆ	GLĘBOKOŚĆ	WYSOKOŚĆ			kg	m3	szt		

ELEMENTY DODATKOWE DO SZAF

	796	18	1754	VH51D	185,-	16.5	0.042	1		
	596	18	1754	VH62D	130,-	14.3	0.059	1		drzwi uniwersalne(lewe i prawe) bez zamka
	796	18	1050	VH31D	160,-	11.8	0.025	1		
	796	18	699	VH11D	130,-	6.9	0.020	1		
	596	18	699	VH10D	105,-	5.0	0.026	1		drzwi uniwersalne(lewe i prawe) bez zamka
	1050	397	5	VHS23	240,-	11.0	0.040	1		drzwi szklane(2szt.)3OH, szkło hartowane bezbarwne, bez zamka
	794	20	1050	HS300	640,-	10.3	0.037	1		drzwi szklane(2szt.)3OH z ramka alumiuniowa, uniwersalne, szkło hartowane mleczne, bez zamka

LEGENDA:

- WAGA NETTO

- OBJĘTOŚĆ

- ILOŚĆ PACZEK

▶ ECHO

ELEMENTY PŁYTOWE

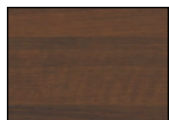

106 - ORZECH
NIZINNY

BIURKA
PRZYSTAWKI

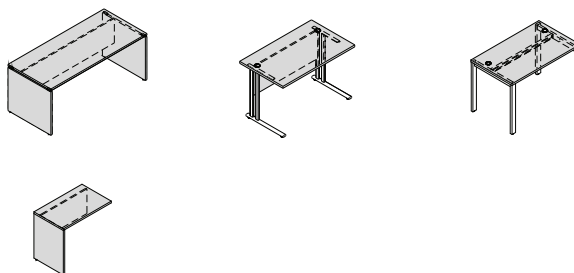

SZAFY
KONTENERY
OPCJONALNE TOPY DO SZAF



STOŁY KONFERENCYJNE
STOLIKI

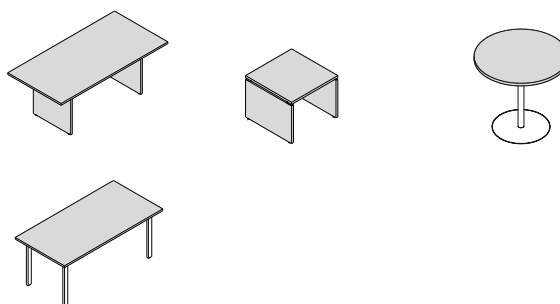

ELEMENTY METALOWE



09 - ALUMINIUM

BIURKA

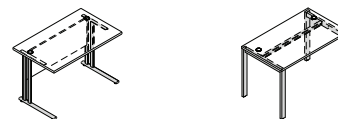

STOŁY KONFERENCYJNE
STOLIKI

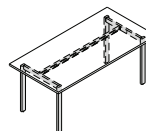

09 - ALUMINIUM

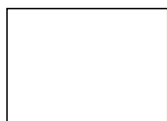

15 - BIAŁY POŁYSK

KOLUMNA

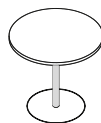

BLAT

plyta melaminowana 28mm, obrzeże PVC 2mm

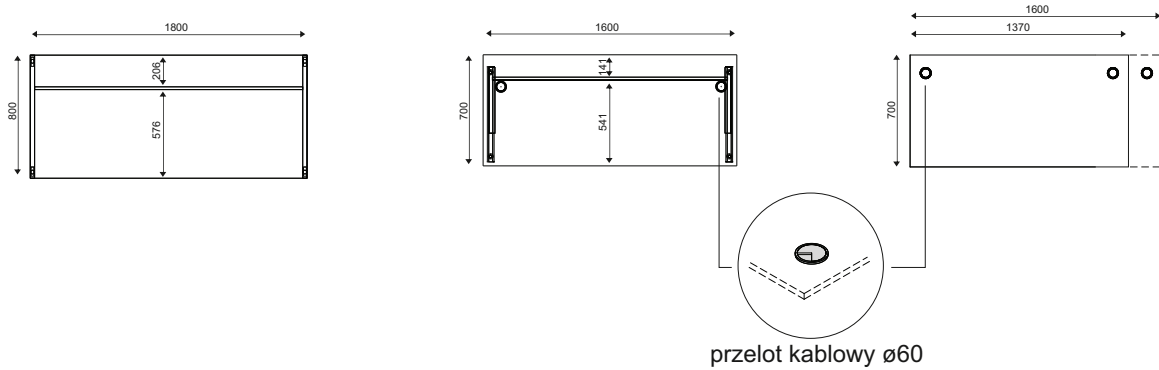

PODSTAWA

nogi płytowe

- płyta melaminowana 18mm

blenda

- płyta melaminowana 18mm

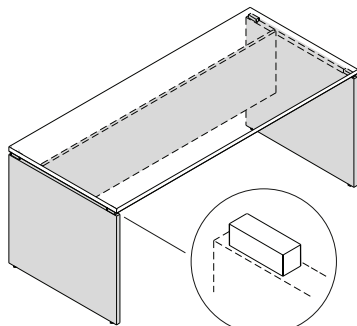

DYSTANSE
20x60mm
09-aluminium

nogi metalowe

- metal malowany proszkowo

blenda

- płyta melaminowana 18mm

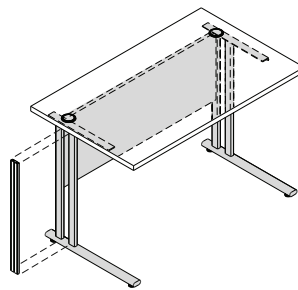

ELEMENT DODATKOWY
kanał kablowy (2 szt.)

stelaż

- metal malowany proszkowo
profil 30x60

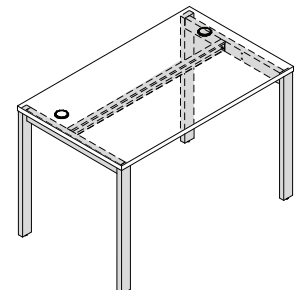

KONTENERY

WIENIEC GÓRNY

plyta melaminowana 28mm,
obrzeże PVC 2mm

KORPUS

plyta melaminowana 18mm
kółka (2 z hamulcem, 2 bez)

FRONT

plyta melaminowana 18mm
zamek centralny

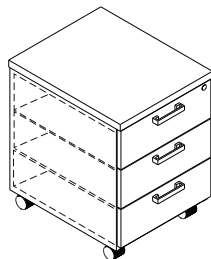

8. KONTENERY

BLAT, NOGA PŁYTOWA

plyta melaminowana 28mm

BLENDĄ

plyta melaminowana 18mm

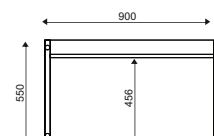
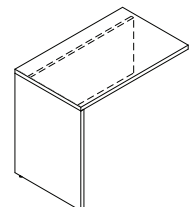

SZAFY I REGAŁY

WIENIEC GÓRNY

plyta melaminowana 28mm, obrzeże PVC 2mm

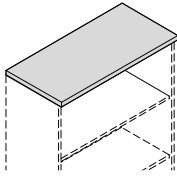

ELEMENT DODATKOWY

top do szaf

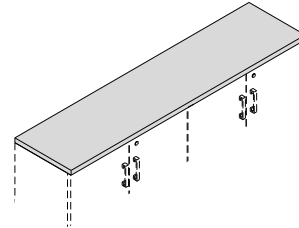

KORPUS

plyta melaminowana 18mm

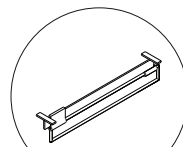
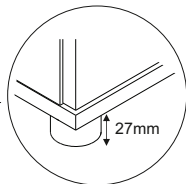
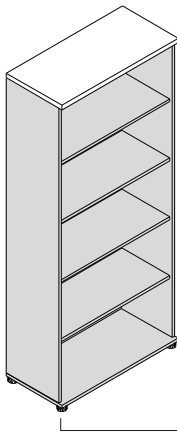

wieszak wysuwny
chromowany

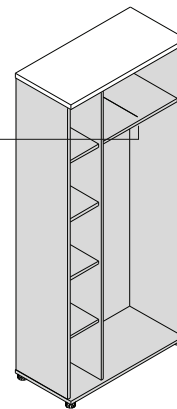

EC52
szafa ubraniowo-aktowa bez zamka

FRONT DO SZAF I REGAŁÓW

drzwi płytowe
- płyta melaminowana 18mm
- zamek patentowy

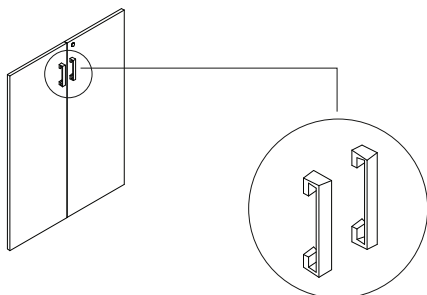

drzwi szklane(2szt.) 3OH
- ramka aluminiowa
- szkło hartowane mleczne
- bez zamka

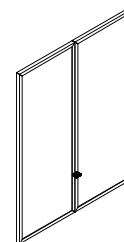

6. STOŁY KONFERENCYJNE

6.1 BLAT

plyta melaminowana 28mm, obrzeże PVC 2mm

6.1 STELAŻ

EC56

stelaż - metal malowany proszkowo
profil - 30x60 mm

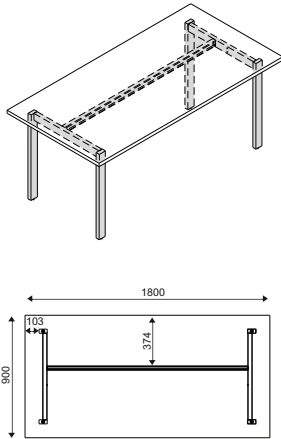
**ECT08**

blat - $\varnothing 800$
talerz - stal nierdzewna, $\varnothing 500$
kolumna - metal malowany proszkowo, $\varnothing 60$

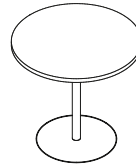

**EC70**

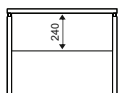
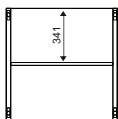
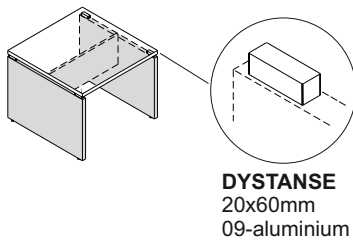
nogi płytowe - płyta melaminowana 28mm
blenda - płyta melaminowana 18mm

**EC20**

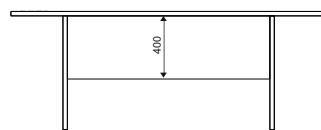
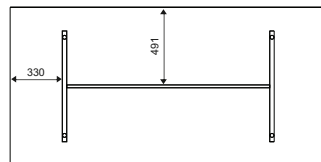
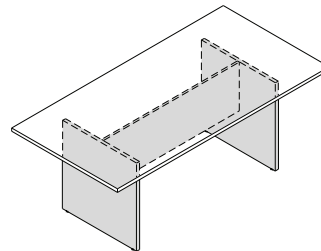
nogi płytowe - płyta melaminowana 28mm
blenda - płyta melaminowana 18mm



WIDOK I RZUT OBIEKTU	WYMIARY [mm]			SYMBOL	CENA NETTO PLN				UWAGI
	SZEROKOŚĆ	GLĘBOKOŚĆ	WYSOKOŚĆ			kg	m3	szt	

BIURKA

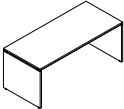
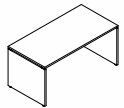
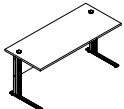
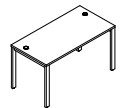
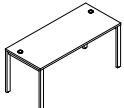
	1800	800	758	EC18	590,-	56.1	0.123	1	
	1600	800	758	EC16	530,-	51.0	0.106	1	
	1600	700	758	EC76	450,-	35.4	0.091	3	
	1370	700	758	EC73	460,-	31.7	0.087	3	
	1600	700	758	EC61	480,-	34.7	0.093	3	

AKCESORIA

	682	50	30	BM01	40,-	0.5	0.004	1	kanal kablowy KPL (2szt)
---	-----	----	----	-------------	------	-----	-------	---	--------------------------

PRZYSTAWKA

	900	550	758	EC90	260,-	21.9	0.042	1	
---	-----	-----	-----	-------------	-------	------	-------	---	--

KONTENER



	435	525	590	EC13	425,-	26.5	0.141	1	
---	-----	-----	-----	-------------	-------	------	-------	---	--

LEGENDA:

 - WAGA NETTO

 - OBJĘTOŚĆ

 - ILOŚĆ PACZEK

WIDOK i RZUT OBIEKTU	WYMIARY [mm]			SYMBOL	CENA NETTO PLN				UWAGI
	SZEROKOŚĆ	GLĘBOKOŚĆ	WYSOKOŚĆ			kg	m3	szt	

STOŁY I STOLIKI

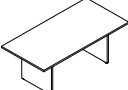
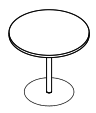
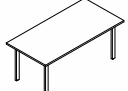

	700	700	550	EC70	390,-	24.0	0.059	1	
	2000	1000	758	EC20	760,-	62.0	0.179	2	
	800	800	730	ECT08	870,-	21.0	0.218	2	
	1800	900	758	EC56	640,-	44.7	0.111	3	

LEGENDA:









 - WAGA NETTO

 - OBJĘTOŚĆ

 - ILOŚĆ PACZEK

WIDOK I RZUT OBIEKTU	WYMIARY [mm]			SYMBOL	CENA NETTO PLN				UWAGI
	SZEROKOŚĆ	GLĘBOKOŚĆ	WYSOKOŚĆ			kg	m ³	szt	

SZAFY I REGAŁY

	802	385	1833	EC51	540,-	58.1	0.142	3	
	802	385	1833	EC52	640,-	55.6	0.131	3	szafa ubraniowo-aktowo, bez zamka
	802	385	1833	EC54	470,-	46.6	0.107	3	
	802	385	1833	EC55	390,-	40.1	0.096	2	
	802	385	1129	EC31	450,-	36.1	0.089	3	
	802	385	1129	EC34	430,-	31.4	0.074	3	
	802	385	1129	EC35	290,-	24.9	0.063	2	
	802	385	777	EC11	350,-	25.5	0.056	3	nadstawka

OPCJONALNE TOPY DO SZAF

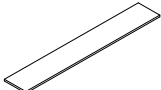

	1604	385	28	EC02	180,-	11.0	0.024	1	
	2406	385	28	EC03	250,-	17.0	0.035	1	

LEGENDA:



 - WAGA NETTO

 - OBJĘTOŚĆ

 - ILOŚĆ PACZEK

WIDOK i RZUT OBIEKTU	WYMIARY [mm]			SYMBOL	CENA NETTO PLN				UWAGI
	SZEROKOŚĆ	GLĘBOKOŚĆ	WYSOKOŚĆ			kg	m3	szt	

ELEMENTY DODATKOWE DO SZAF

	794	20	1050	HS300	640,-	10.3	0.037	1	drzwi szklane(2szt.)3OH z ramka aluminiowa, uniwersalne, szkło hartowane mleczne, bez zamka
	160	110	20	EC01	45,-	0.5	0.000	1	komplet uchwytów (2szt)

LEGENDA:

 - WAGA NETTO

 - OBJĘTOŚĆ

 - ILOŚĆ PACZEK

► LADA SVEN

ELEMENTY PŁYTOWE

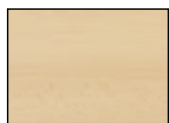

14 - BUK

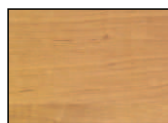

28 - OLCZA



29 - CALVADOS

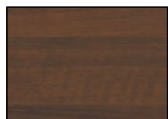

106 - ORZECH
NIZINNY

ELEMENTY HDF

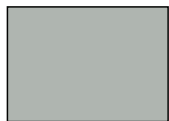

84 - POPIEL

BLAT GÓRNY
BLAT ROBOCZY
FRONT PROSTY
NOGI PŁYTOWE

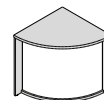
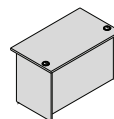

FRONT ŁUKOWY

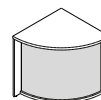

BLAT GÓRNY, BLAT ROBOCZY

plyta melaminowana 28mm, obrzeże PVC 2mm

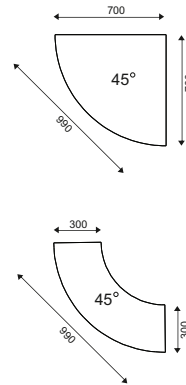
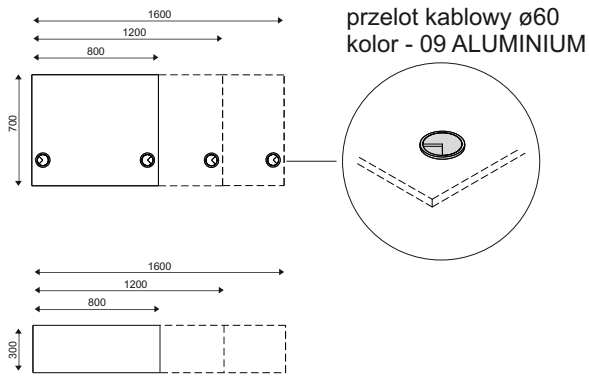

FRONT- LADA PROSTA

plyta melaminowana 18mm

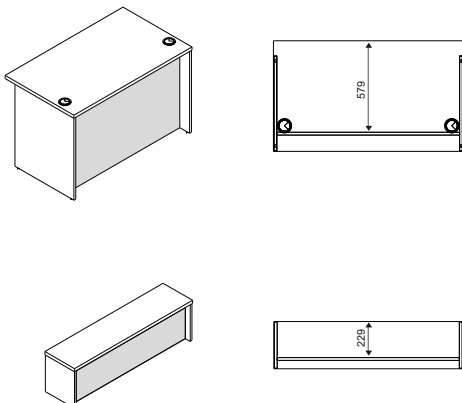

FRONT - LADA ŁUKOWA

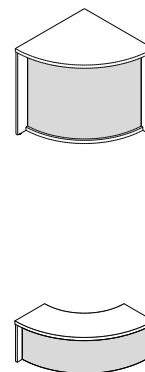

plyta HDF 3mm, kolor 26-aluminium satynato



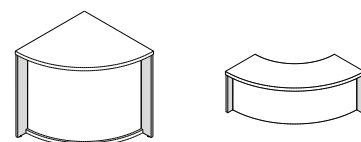
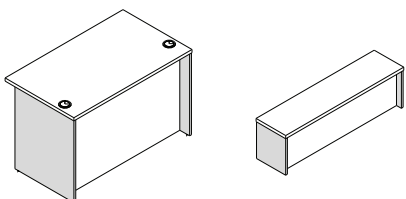

NOGI PŁYTOWE, BOKI NADSTAWKI

plyta melaminowana 18mm



WIDOK i RZUT OBIEKTU	WYMIARY [mm]			SYMBOL	CENA NETTO PLN				UWAGI
	SZEROKOŚĆ	GLĘBOKOŚĆ	WYSOKOŚĆ			kg	m3	szt	

LADA SVEN

	800	300	352	LH70BG	235,-	9.3	0.020	1	
	1200	300	352	LH72BG	255,-	14.3	0.029	1	
	1600	300	352	LH76BG	290,-	16.5	0.037	1	
	990	300	352	LH90BG	265,-	8.9	0.022	1	
	800	700	758	LH70B	345,-	28.3	0.055	1	
	1200	700	758	LH72B	370,-	37.5	0.081	1	
	1600	700	758	LH76B	460,-	41.5	0.083	1	
	990	700	758	LH90B	410,-	25.4	0.068	1	

LEGENDA:

 - WAGA NETTO - OBJĘTOŚĆ - ILOŚĆ PACZEK

► LADA VERONA

ELEMENTY PŁYTOWE



67-BIAŁY
PASTEL



106 - ORZECH
NIZINNY

BLAT GÓRNY
BLAT ROBOCZY
FRONT PROSTY
NOGI PŁYTOWE

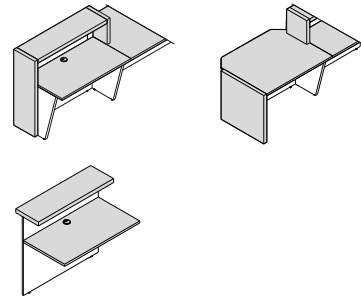

ELEMENTY PŁYTOWE



67-BIAŁY
PASTEL

KORPUS
FRONT PŁYTOWY

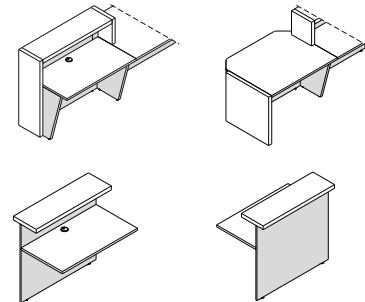

ELEMENTY HPL

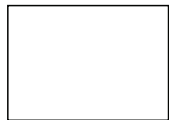

73-BIAŁY POŁYSK



74-POMARAŃCZOWY
POŁYSK



80-ZIELONY POŁYSK



81-BORDOWY
POŁYSK

FRONT HPL

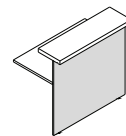

PRZELOTY KABLOWE

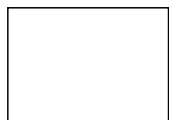

67-BIAŁY
PASTEL

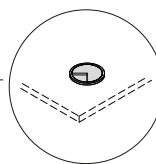
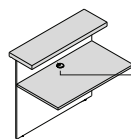

BIAŁY

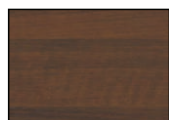

106 - ORZECH
NIZINNY

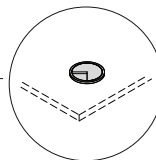
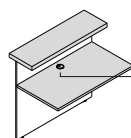

CZARNY

BLAT GÓRNY

plyta melaminowana 52mm, obrzeże PVC 2mm

BLAT ROBOCZY

plyta melaminowana 28mm, obrzeże PVC 2mm

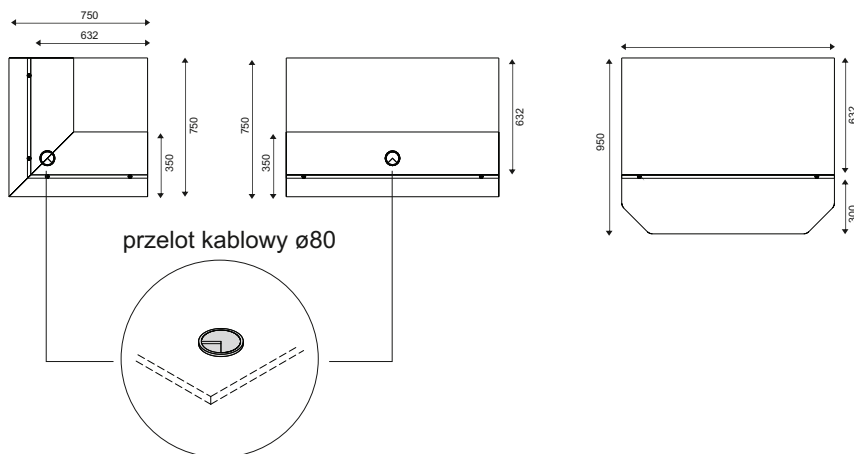

FRONT

plyta melaminowana 18mm, lub płyta melaminowana 18mm + HPL

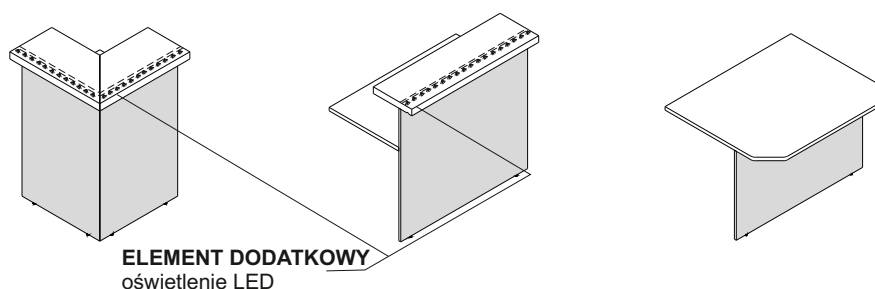

ELEMENTY KOŃCZĄCE

plyta melaminowana 52mm, obrzeże PVC 2mm

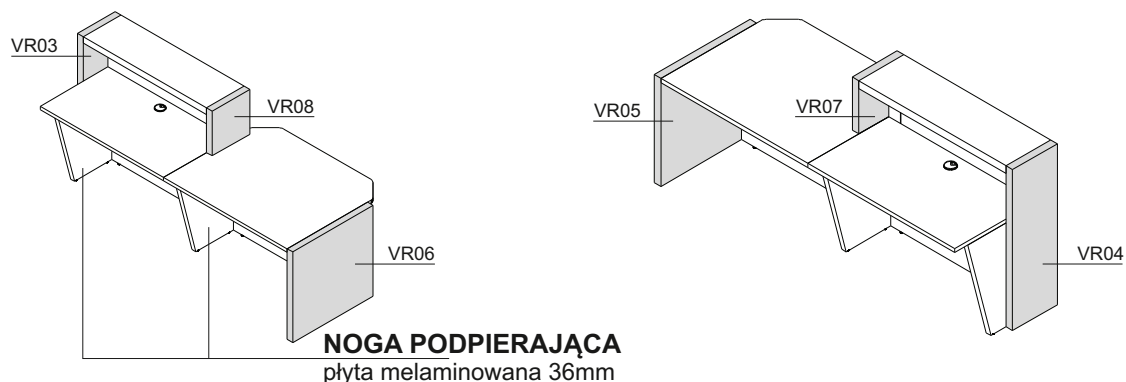

NOGA PODPIERAJĄCA

plyta melaminowana 36mm

noga pakowana z blatem
(cena blatu uwzględnia nogę podpierającą)

LADA VERONA

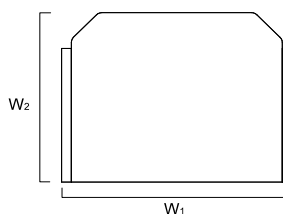
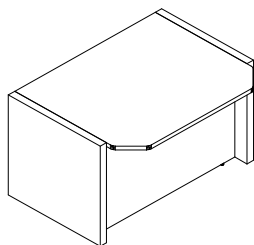

SYMBOL	WYMIARY [mm]					PLN				UWAGI
	W ₁	W ₂	D ₁	D ₂	H		kg	m ³	szt	
VR13	1254	950	-	-	740	1 060,-	74.0	0.199	4	
VR13H	1254	950	-	-	740	1 180,-	74.0	0.199	4	

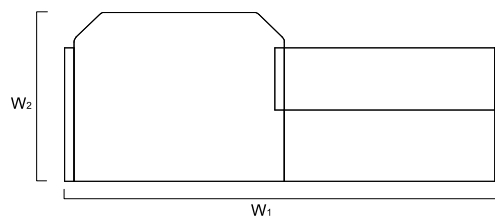
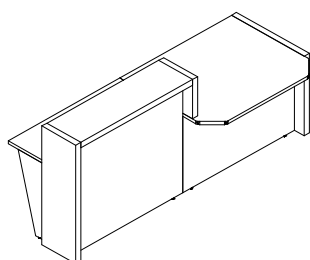

SYMBOL	WYMIARY [mm]					PLN				UWAGI
	W ₁	W ₂	D ₁	D ₂	H		kg	m ³	szt	
VR14	2404	950	-	-	1100	2 060,-	117.0	0.348	7	
VR14H	2404	950	-	-	1100	2 354,-	118.0	0.348	7	

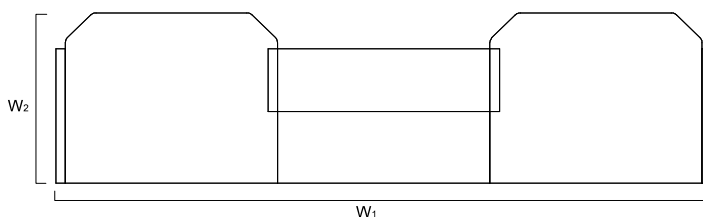
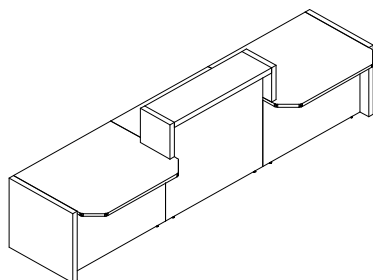

SYMBOL	WYMIARY [mm]					PLN				UWAGI
	W ₁	W ₂	D ₁	D ₂	H		kg	m ³	szt	
VR15	3554	950	-	-	1100	2 710,-	173.0	0.452	10	
VR15H	3554	950	-	-	1100	3 124,-	174.0	0.452	10	

LEGENDA:

- WAGA NETTO

- OBJĘTOŚĆ

- ILOŚĆ PACZEK

LADA VERONA

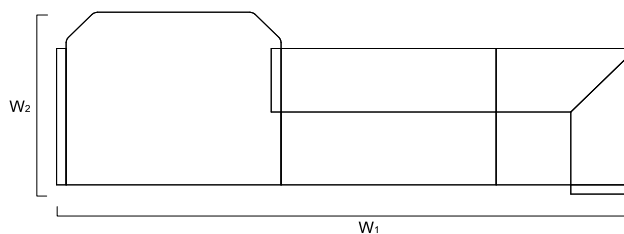
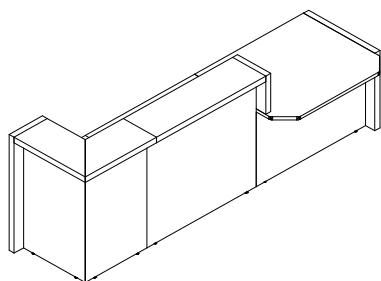

SYMBOL	WYMIARY [mm]					PLN				UWAGI
	W ₁	W ₂	D ₁	D ₂	H		kg	m ³	szt	
VR16	3102	1002	-	-	1100	2 960,-	200.0	1.008	9	
VR16H	3102	1002	-	-	1100	3 457,-	201.0	1.008	9	

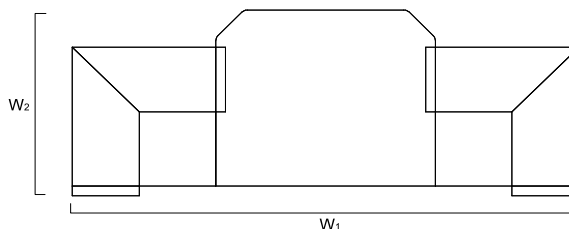
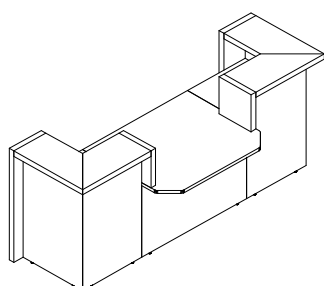

SYMBOL	WYMIARY [mm]					PLN				UWAGI
	W ₁	W ₂	D ₁	D ₂	H		kg	m ³	szt	
VR17	2650	1002	-	-	1100	2 860,-	232.0	1.575	10	
VR17H	2650	1002	-	-	1100	3 386,-	232.0	1.575	10	

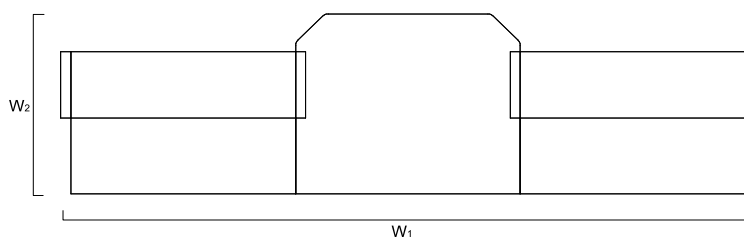
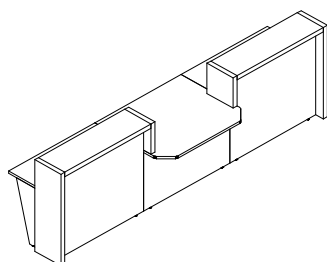

SYMBOL	WYMIARY [mm]					PLN				UWAGI
	W ₁	W ₂	D ₁	D ₂	H		kg	m ³	szt	
VR18	3554	950	-	-	1100	3 060,-	160.0	0.497	10	
VR18H	3554	950	-	-	1100	3 528,-	162.0	0.497	10	

LEGENDA:

- WAGA NETTO

- OBJĘTOŚĆ

- ILOŚĆ PACZEK

LADA VERONA

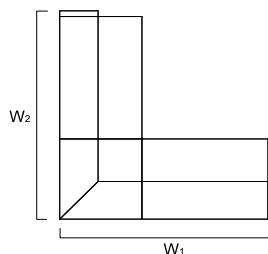
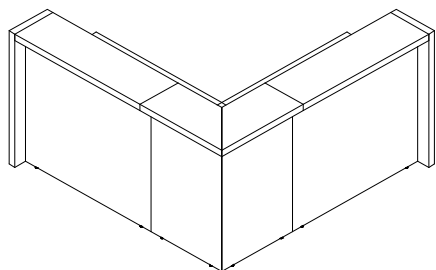

SYMBOL	WYMIARY [mm]					PLN				UWAGI
	W ₁	W ₂	D ₁	D ₂	H		kg	m ³	szt	
VR19	1952	1952	-	-	1100	3 160,-	191.0	1.025	8	
VR19H	1952	1952	-	-	1100	3 711,-	193.0	1.025	8	

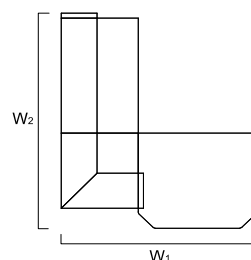
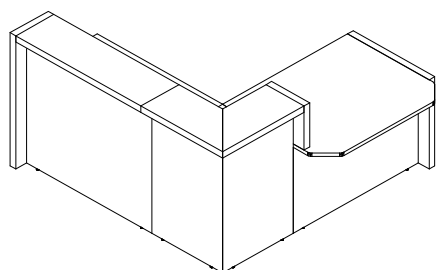

SYMBOL	WYMIARY [mm]					PLN				UWAGI
	W ₁	W ₂	D ₁	D ₂	H		kg	m ³	szt	
VR20	1952	2152	-	-	1100	2 960,-	200.0	1.008	9	
VR20H	1952	2152	-	-	1100	3 457,-	201.0	1.008	9	

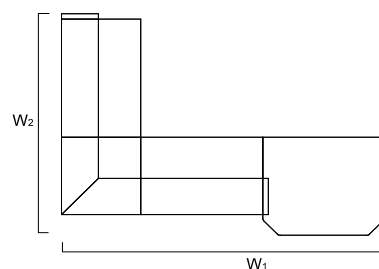
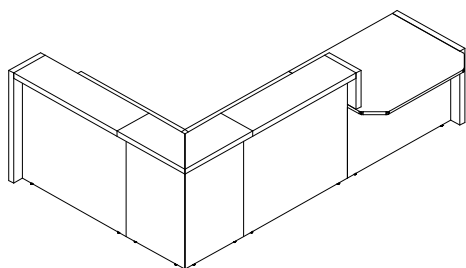

SYMBOL	WYMIARY [mm]					PLN				UWAGI
	W ₁	W ₂	D ₁	D ₂	H		kg	m ³	szt	
VR21	3102	2152	-	-	1100	3 810,-	247.0	1.129	11	
VR21H	3102	2152	-	-	1100	4 481,-	249.0	1.129	11	

LEGENDA:

- WAGA NETTO

- OBJĘTOŚĆ

- ILOŚĆ PACZEK

LADA VERONA

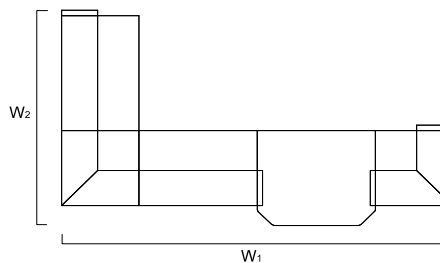
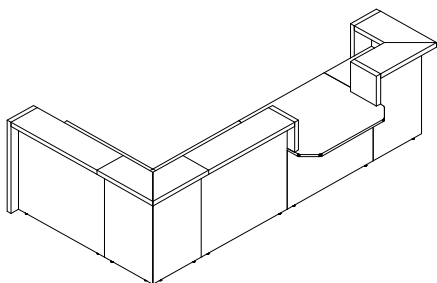

SYMBOL	WYMIARY [mm]					PLN				UWAGI
	W ₁	W ₂	D ₁	D ₂	H		kg	m ³	szt	
VR22	3800	2152	-	-	1100	4 860,-	326.0	1.817	14	
VR22H	3800	2152	-	-	1100	5 734,-	328.0	1.817	14	

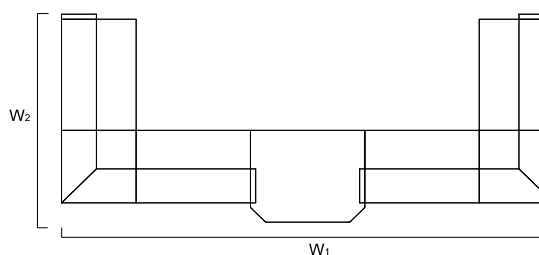
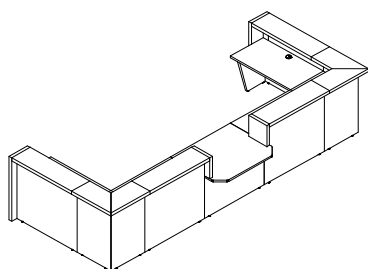

SYMBOL	WYMIARY [mm]					PLN				UWAGI
	W ₁	W ₂	D ₁	D ₂	H		kg	m ³	szt	
VR23	4950	2152	-	-	1100	6 560,-	420.0	2.060	18	
VR23H	4950	2152	-	-	1100	7 782,-	424.0	2.060	18	

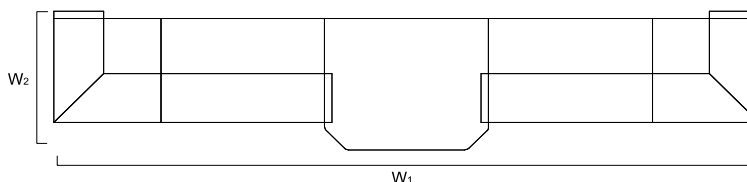
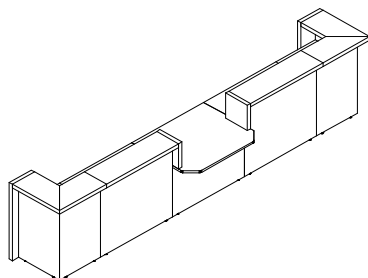

SYMBOL	WYMIARY [mm]					PLN				UWAGI
	W ₁	W ₂	D ₁	D ₂	H		kg	m ³	szt	
VR24	4950	1002	-	-	1100	4 860,-	326.0	1.817	14	
VR24H	4950	1002	-	-	1100	5 734,-	328.0	1.817	14	

LEGENDA:

- WAGA NETTO

- OBJĘTOŚĆ

- ILOŚĆ PACZEK

LADA VERONA

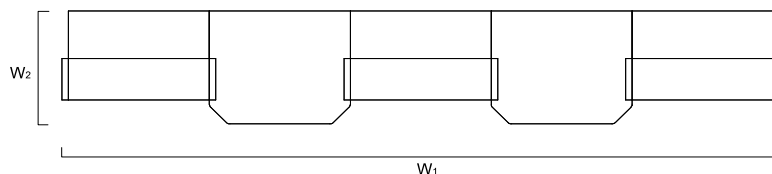
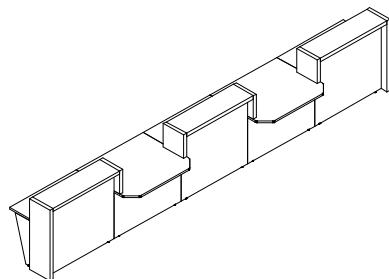

SYMBOL	WYMIARY [mm]					PLN				UWAGI
	W ₁	W ₂	D ₁	D ₂	H		kg	m ³	szt	
VR25	5854	950	-	-	1100	4 710,-	259.0	0.751	16	
VR25H	5854	950	-	-	1100	5 472,-	262.0	0.751	16	

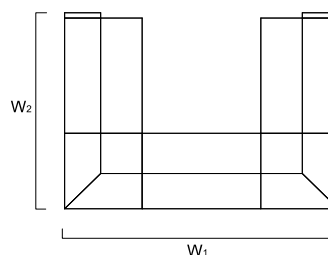
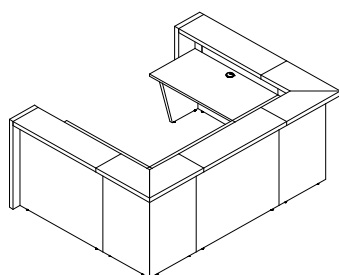

SYMBOL	WYMIARY [mm]					PLN				UWAGI
	W ₁	W ₂	D ₁	D ₂	H		kg	m ³	szt	
VR26	2650	1952	-	-	1100	4 910,-	321.0	1.806	12	
VR26H	2650	1952	-	-	1100	5 838,-	324.0	1.806	12	

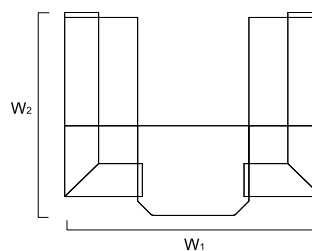
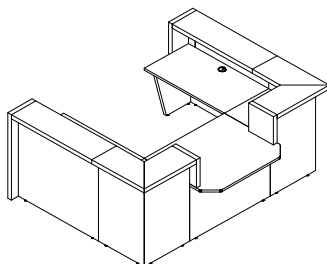



SYMBOL	WYMIARY [mm]					PLN				UWAGI
	W ₁	W ₂	D ₁	D ₂	H		kg	m ³	szt	
VR27	2650	2152	-	-	1100	4 860,-	326.0	1.817	14	
VR27H	2650	2152	-	-	1100	5 734,-	328.0	1.817	14	

LEGENDA:

- WAGA NETTO

- OBJĘTOŚĆ



- ILOŚĆ PACZEK

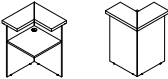
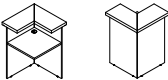
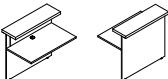
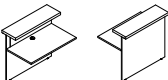
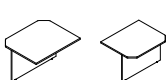
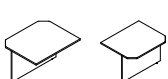
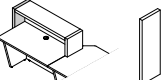
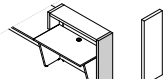
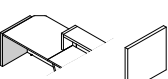
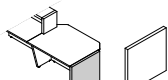
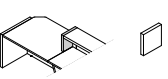

WIDOK i RZUT OBIEKTU	WYMIARY [mm]			SYMBOL	CENA NETTO PLN					UWAGI
	SZEROKOŚĆ	GLĘBOKOŚĆ	WYSOKOŚĆ			kg	m3	szt		

ELEMENTY SKŁADOWE





	750	750	1100	VR01	900,-	83.0	0.660	2		
	750	750	1100	VR01H	1 103,-	83.0	0.660	2		
	1150	750	1100	VR02	850,-	47.0	0.121	2		
	1150	750	1100	VR02H	1 024,-	48.0	0.121	2		
	1150	950	740	VR10	500,-	40.0	0.108	2		
	1150	950	740	VR10H	620,-	40.0	0.108	2		
	350	52	1100	VR03	280,-	7.0	0.061	1		bok wysoki, lewy
	350	52	1100	VR04	280,-	7.0	0.061	1		bok wysoki, prawy
	750	52	730	VR05	280,-	17.0	0.045	1		bok niski, lewy
	750	52	730	VR06	280,-	17.0	0.045	1		bok niski, prawy
	350	52	360	VR07	150,-	6.0	0.012	1		bok nadstawki, lewy

LEGENDA:

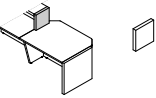

 - WAGA NETTO - OBJĘTOŚĆ - ILOŚĆ PACZEK

WIDOK i RZUT OBIEKTU	WYMIARY [mm]			SYMBOL	CENA NETTO PLN				UWAGI
	SZEROKOŚĆ	GLĘBOKOŚĆ	WYSOKOŚĆ			kg	m3	szt	

ELEMENTY SKŁADOWE

	350	52	360	VR08	150,-	6.0	0.012	1	bok nadstawki prawy
	650			VR11	130,-	1.0	0.002	1	listwa ledowa do lady VR01
	1100			VR12	90,-	1.0	0.002	1	listwa ledowa do lady VR02 i VR10
	100	100	100	VR09	270,-	2.0	0.002	1	zasilacz; zasilanie max. 4 modułów ład.

LEGENDA:

 - WAGA NETTO - OBJĘTOŚĆ - ILOŚĆ PACZEK