

Syst-eM 
& shared area

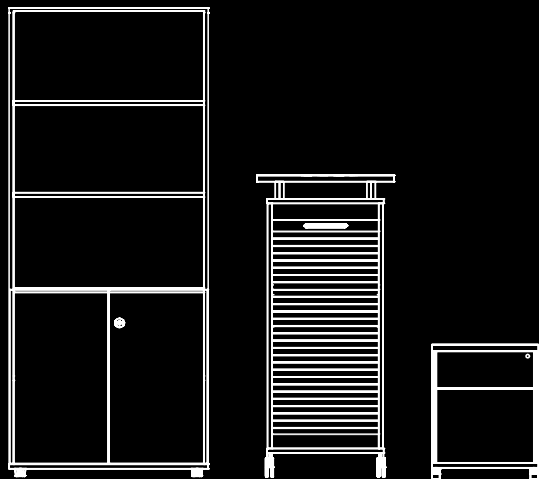
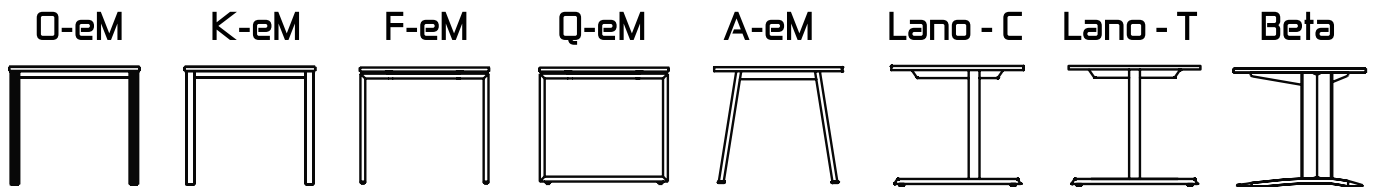
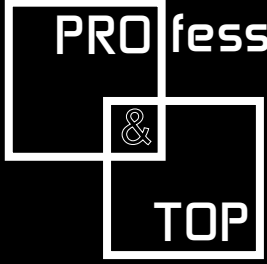

Cabinet 
system

Q-eM

Work & shared area



02
maro

03
maro

A-eM

F-eM



04
marzo

05
marzo

Lano-T



06
maro

07
maro



Lano-T

08
marzo

09
marzo



F-eM

your place of work

10
maro

11
maro

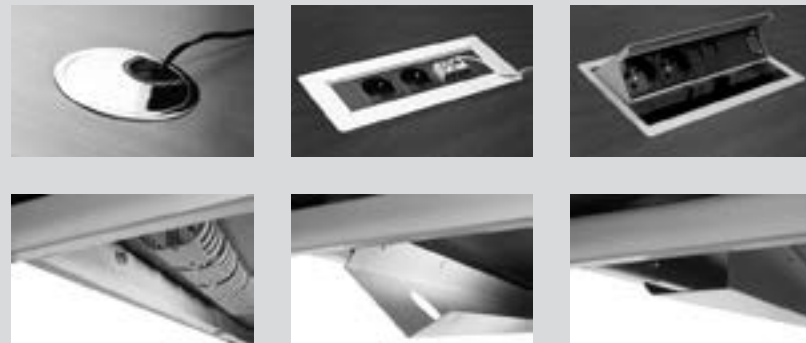

more info maro.com.pl

Beta

your style

12
marzo

13
marzo



K-eM

share your place

14
maro

15
maro

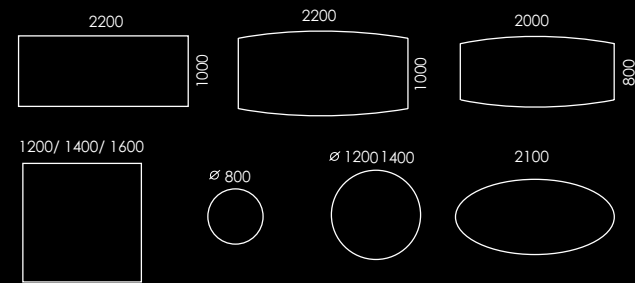

Stoly konferencyjne/ Conference tables/ Konferenztische



Q-eM

16
maro

17
maro



O-eM

K-eM

18
maro

19
maro



Lano- E

Idea



20
maro

21
maro



Panelle sterujące/ Control panel/ Höhensteuerung



Accessories-eM



22
maro

Idea



23
maro

dynamic communication



more info maro.com.pl

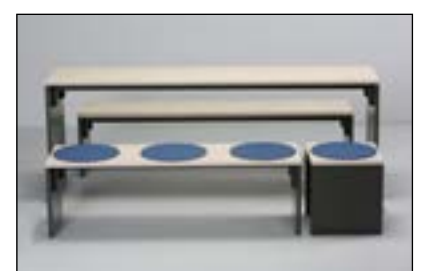

more info maro.com.pl

Lano - C

Screen S30



24
marzo

25
marzo

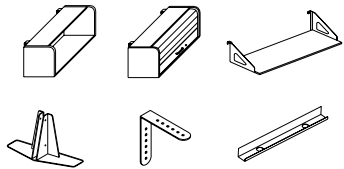
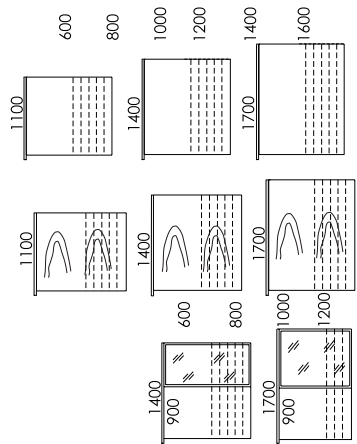

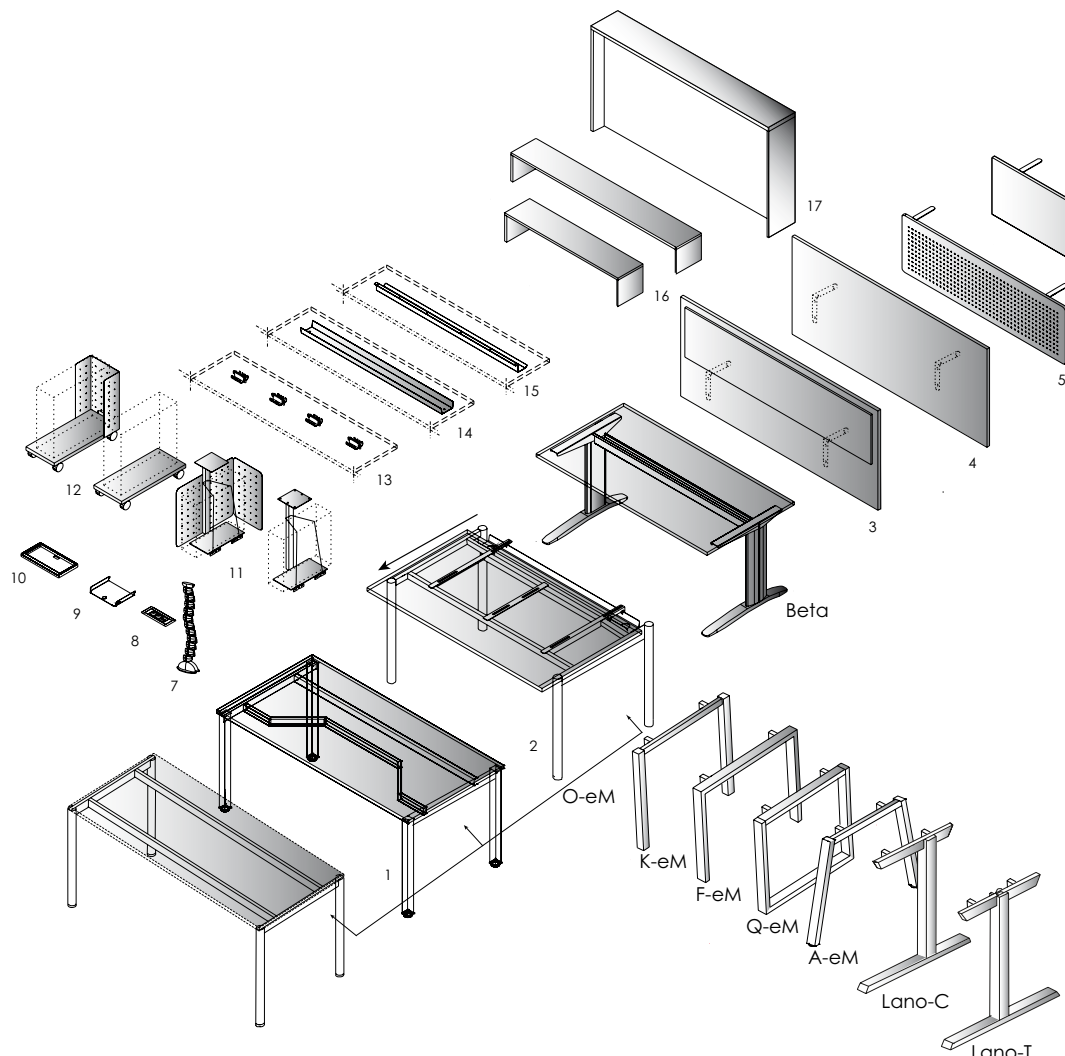
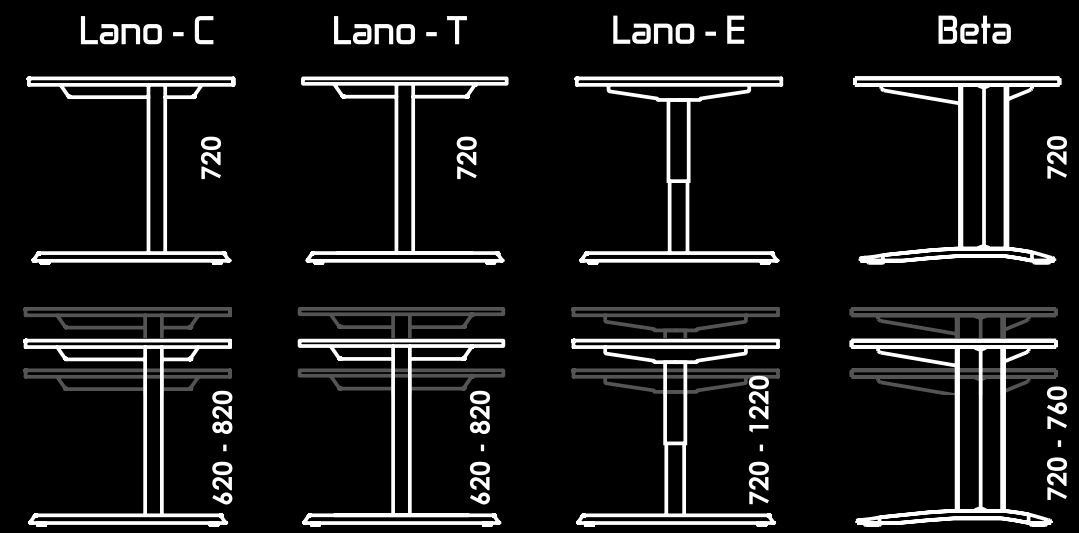
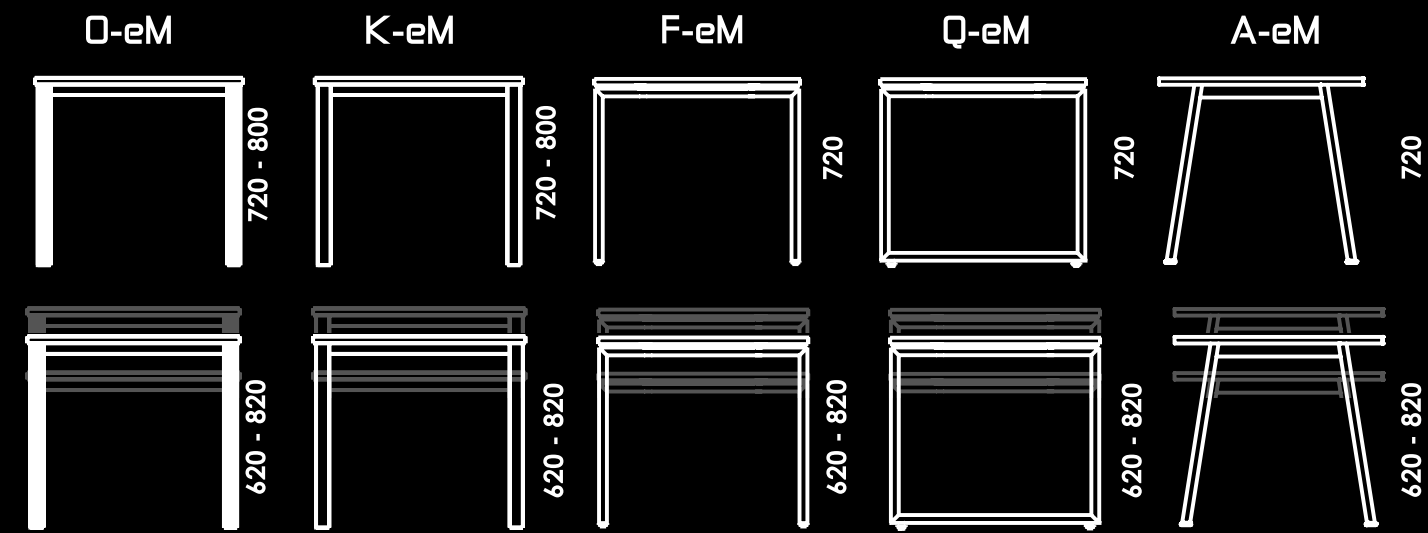

1. Stelaż ergonomiczny/ Ergonomic desk frame/
Ergonomisches Schreibtischgestell
2. Blat przesuwny/ Sliding top/ Schiebeplatte
3. Przegroda podwieszana z pinpanelem/
Privacy screen with fabric pinboard/
Frontsichtblende mit Pinpaneel
4. Przegroda podwieszana/ Privacy screen/
Frontsichtblende
5. Zabudowa rastrowa/ Perforated modesty panel/
Knieblende - Lochblech
6. Zabudowa płytowa/ Melamine modesty panel/
Knieblende - Melamin
7. Elastyczny kanał kablowy/ Flexible cable spine/
Flexibler Kabelkanal
8. Mediaport uchylny/ Netbox/
Strom-Daten-Box
9. Półka na dokumenty/ Metal shelf/
Organisationshilfe
10. Szuflada pod klawiaturę/ Keyboard tray/
Tastaturauszug
11. Wspornik pod komputer/ PC- holder/
PC- Halter
12. Mobilna podstawa pod komputer/
PC- trolley/ PC- Wagen
13. Uchwyty kablowe/ Cable clamps/
Kabelklemmer
14. Kanał kablowy poziomy stały/
Fixed horizontal cable channel/
Fester Kabelkanal
15. Kanał kablowy poziomy uchylny/
Fold-down horizontal cable channel/
Klappbarer Kabelkanal
16. Nadstawka pełna/ Desktop hutch/
Schreibtischaufsatz
17. Panel recepcyjny prosty/ Reception panel/
Empfangstheke

Biurka/ Desks/ Schreibtische

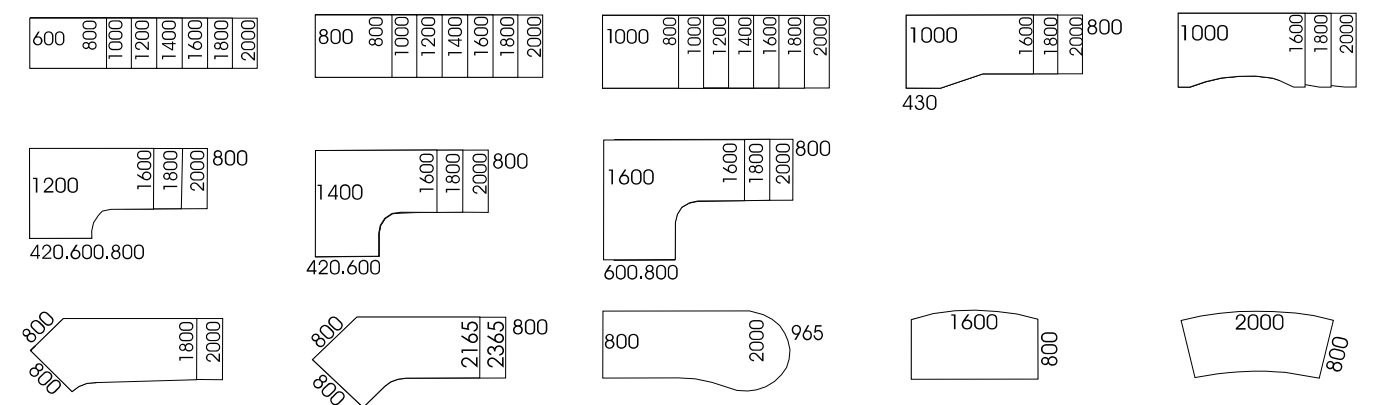

Stoły konferencyjne/ Conference tables/ Konferenztische

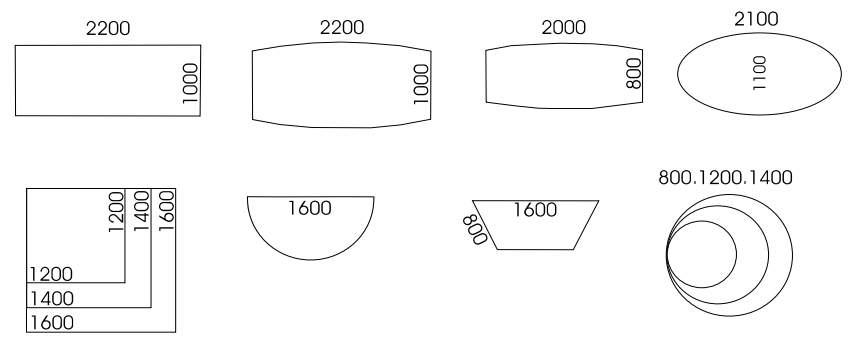

Przystawki i łączniki/ Add-on tables/ Anstellische

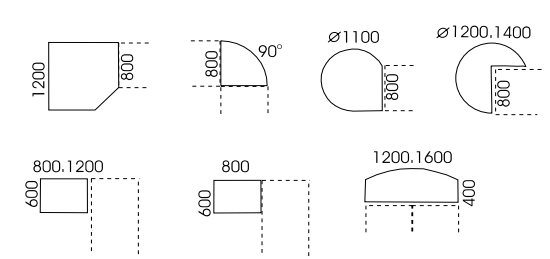

27
maro

bench

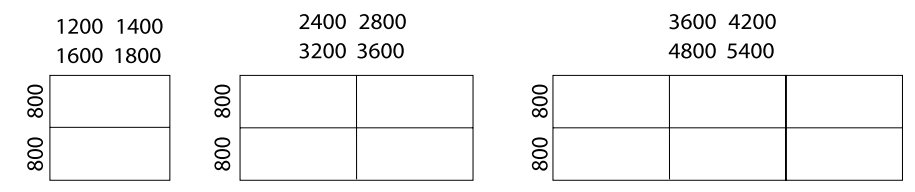

Accessories-eM

Syst-eM **Work**
& shared area

28
marzo

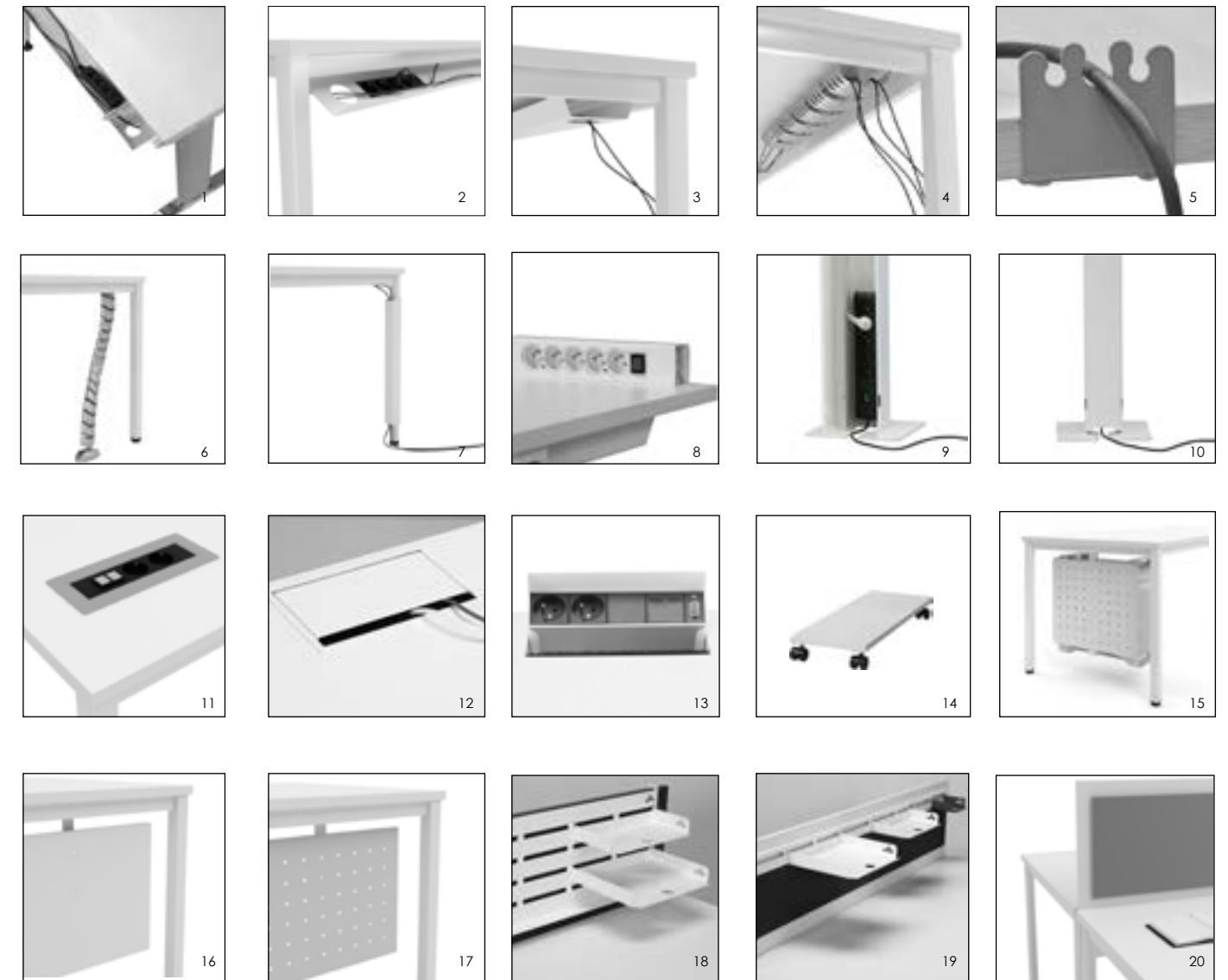

- | | | | | |
|---|--|---|---|---|
| 1. Blat przesuwny
Sliding top
Schiebeplatte | 2. Kanał kablowy poziomy uchylny
Fold-down horizontal
cable channel
Klappbarer Kabelkanal | 3. Kanał kablowy poziomy stały
Fixed horizontal cable channel
Fester Kabelkanal | 4. uchwyt kablowy
cable clamp
Kabelklemmer | 5. Uchwyt kablowy
Cable holder
Kabelklemmer |
| 6. Kanał kablowy elastyczny
Flexible cable spine
Flexibler Kabelkanal | 7. Kanał kablowy pionowy
Vertical cable channel
Vertikaler Kabelkanal | 8. Mini mediaport
Power strip
Steckdosenleiste mit Schalter | 9. Kanał kablowy pionowy
wolnostojący otwarty
Freestanding vertical cable duct
(open)
Freistehender vertikaler Kabelkanal
(geöffnet) | 10. Kanał kablowy pionowy
wolnostojący zamknięty
Freestanding vertical cable duct
(closed)
Freistehender vertikaler Kabelkanal
(geschlossen) |
| 11. Mediaport obrotowy
Netbox turn
Strom-Daten-Box | 12. Przelotka prostokątna
Rectangular cable outlet
Kabelset rechteckig | 13. Mediaport uchylny
Netbox
Elektrifizierungsmodul | 14. Podstawa pod komputer
PC - trolley
PC - Wagen | 15. Wspornik pod komputer
z zabudową rastrową
PC-holder with protective cover
PC-Halter mit Sichtschutzblende |
| 16. Zabudowa płytowa
Melamine modesty panel
Knieblende - Melamin | 17. Zabudowa rastrowa
Perforated modesty panel
Knieblende - Lochblech | 18. Akcesoria organizacyjne
Accessories
Zubehör | 19. Akcesoria organizacyjne
Accessories
Zubehör | 20. Przegroda podwieszana
z panelem tapicerowanym
Privacy screen with fabric pinboard
Frontsichtblende mit Pinpaneel |

K-eM

Lano -T

work with me here

30
maro

31
maro



I-eM

your conference room

34
maro

35
maro



I-eM



36
maro

V-eM



37
maro

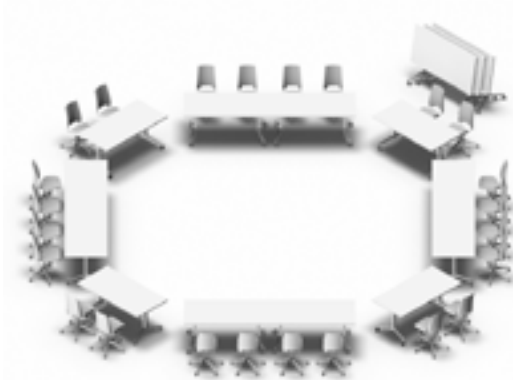
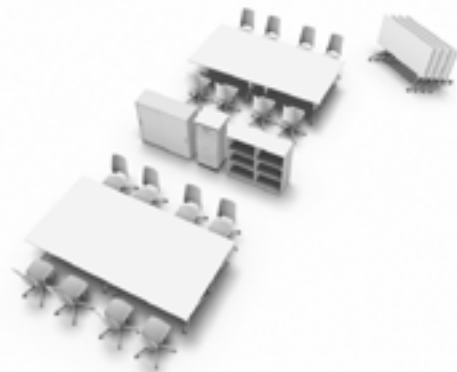
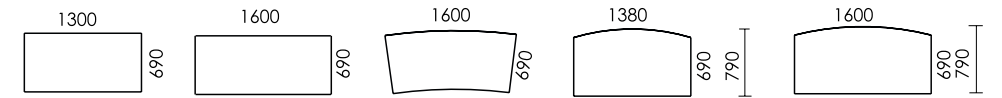
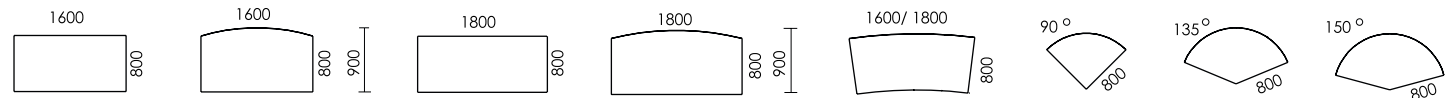

Archive

Nadstawki
Add-on units
Aufsatzschränke

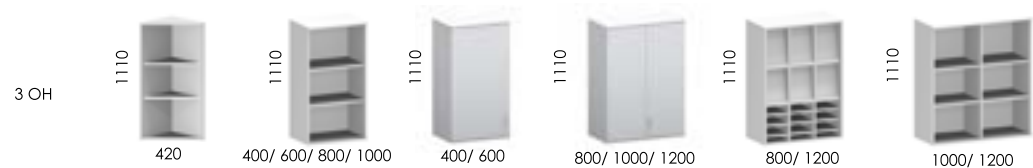
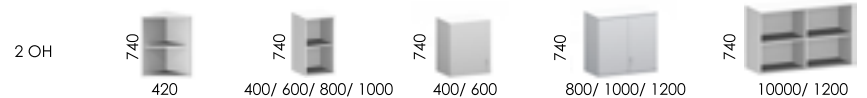

Szafy i regaly
Cabinets and open shelves
Schränke und Regale

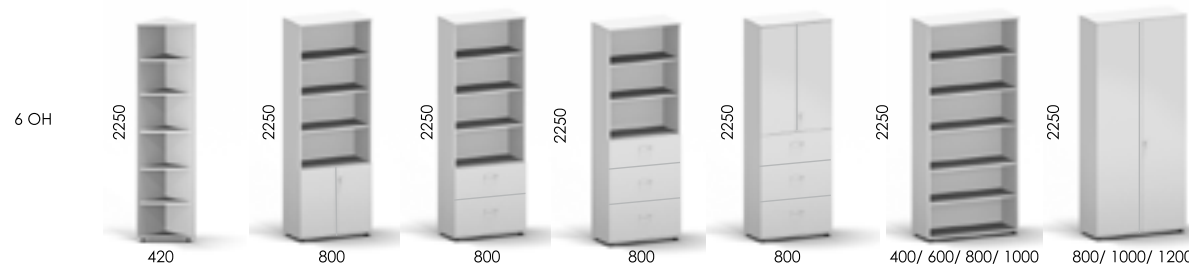
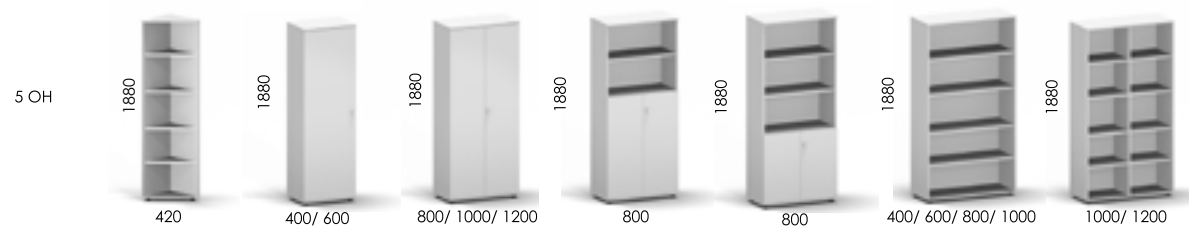
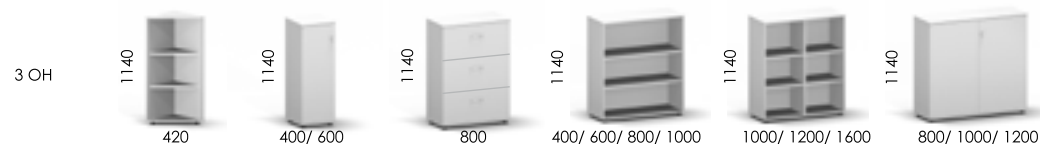
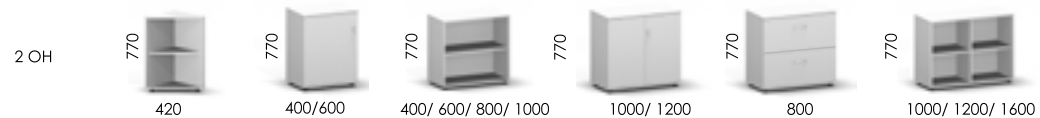

Zawias 100°
100° opening hinge
Türband 100° Öffnungswinkel



Zawias obiektowy 270°
270° opening hinge
Türband 270° Öffnungswinkel



Zamek baskwilowy
Cylinder lock
Zylinderschloss



Wieszak wysuwny
Pull-out clothes rail
Ausziehbare Kleiderstange



Półka metalowa z przegrodami, płytowa 25 mm, płytowa 18 mm
Metal shelf, melamine shelf 25 mm
melamine shelf 18 mm
Metall-, Melaminfachboden 25mm,
Melaminfachboden 18mm

PROfessional cabinet



39
maro





40
maro



Stopka poziomująca
H=30 mm
Glides with height
adjustment screw
H=30 mm
Gleiter mit
Verstellgleiter H=30 mm



Cokół metalowy
H=30 mm
Metal base
H=30 mm
Stahlsockel
H=30 mm



Stelaż metalowy 30x30
H=150 mm
Metal frame 30x30
H=150 mm
Metallgestell 30x30
H=150 mm



Stelaż metalowy Ø30
H=150 mm
Metal frame Ø30
H=150 mm
Metallgestell Ø30
H=150 mm



Szafa z drzwiami przesuwными
Sliding door cabinet
Schiebetürenschränk



Opcja: prowadnica biała
Option: white sliding guide
Option: weiße Führung



Szafa żaluzjowa
Shutter door cabinet
Rollladenschränk



Opcja: prowadnica biała
Option: white sliding guide
Option: weiße Führung

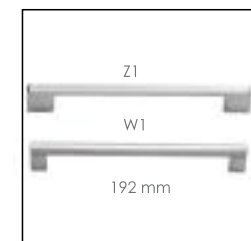

Uchwyty
Handles
Metallgriffe

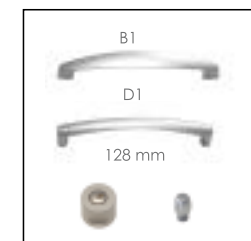

Uchwyty
Handles
Metallgriffe

Szafy dwustronne
Double-sided cabinets
Sideboards mit zweiseitigen Schiebetüren

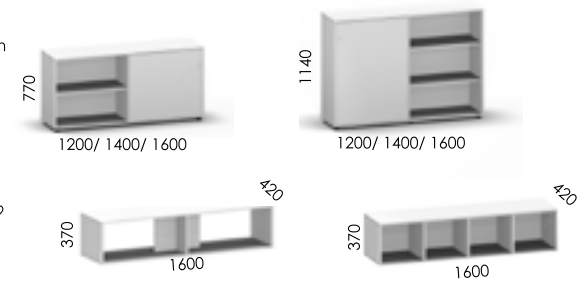

Nadstawki
Add-on units
Aufsatzschränke



Szafy przesuwne - nadstawki
Sliding door add-on units
Schiebetürenaufsatzschränke

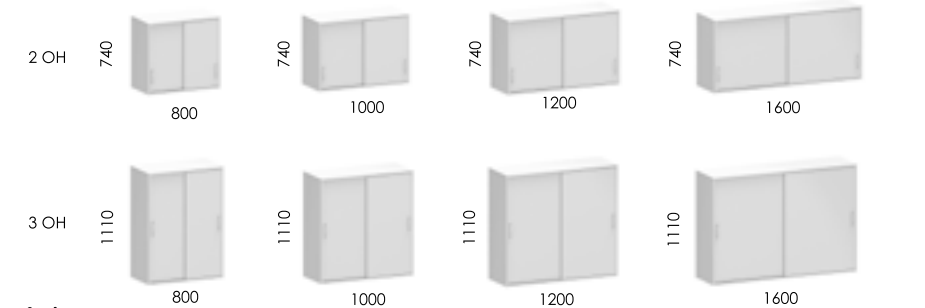

Szafy przesuwne
Sliding door cabinets
Schiebetürenschränke

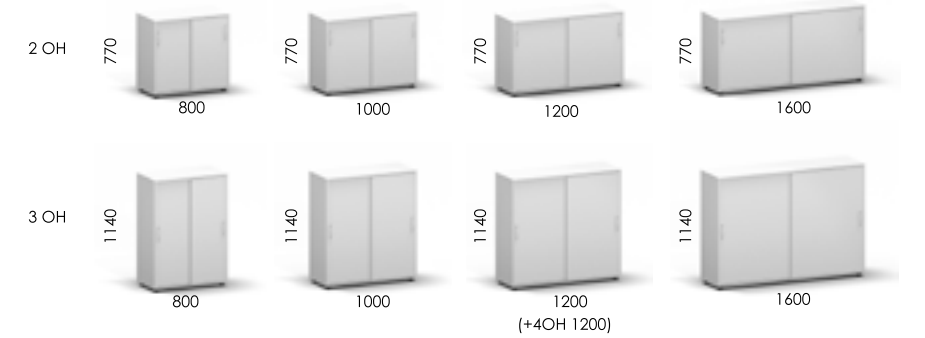

Szafy żaluzjowe - nadstawki
Shutter door add-on units
Rollladenaufsatzschränke

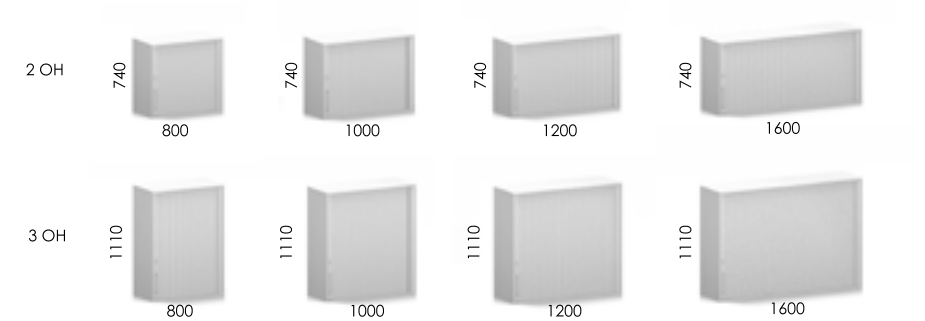

Szafy żaluzjowe
Shutter door cabinets
Rollladenschränke

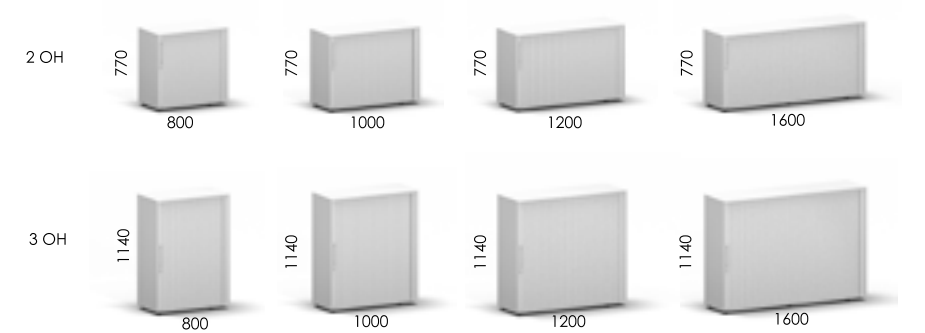



Szuflada na teczki zawieszane
Extension for hanging files
Hängeregistratur - Auszug



Uchwyt do półki
Shelf holder
Fachträger



Poziomowanie
Height adjustment for cabinets
Schrank- Nivellierung



Pinpanel
Fabric pinboard
Pinpaneel

Kontenery mobilne
Mobile pedestals
Rollcontainer

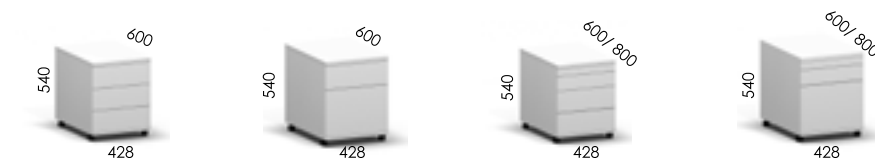

Kontenery stacjonarne
Fixed pedestals
Standcontainer

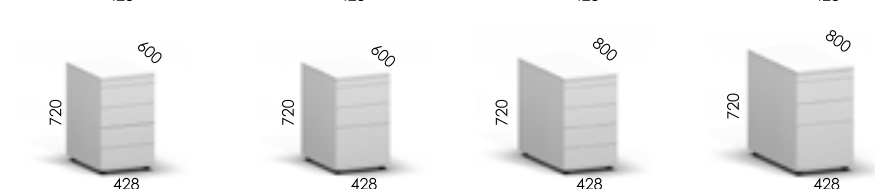

Szafki podbiurkowe
Under desk cabinets
Untertisch Sideboards

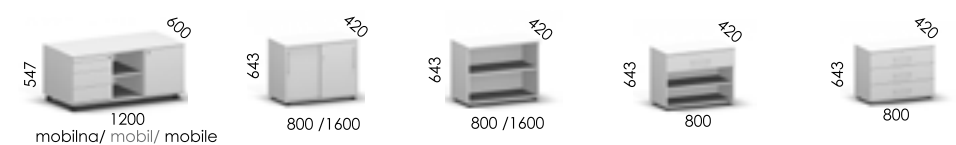

Szafki przybiurkowe
Desk high cabinets
Anstellschränke



Kontenery wysokie
High pedestals
Hochcontainer

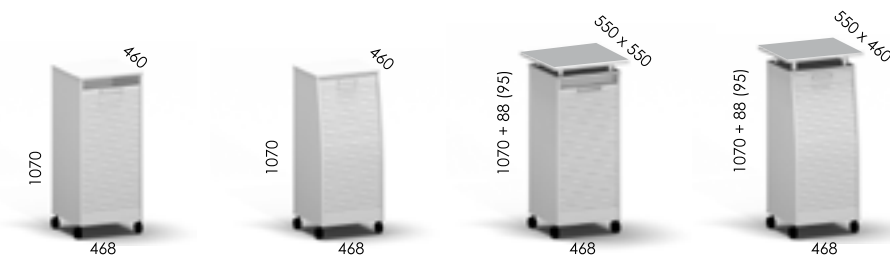

Kontenery eM-Cargo
eM-Cargo tower pedestals
eM-Cargo container



Kluczyk tamany
Folding key
Kippschlüssel

Uchwyt boczny
Side handle
Seitengriff

Piórnik
Pencil tray
Ausziehbrett

Przegroda ukośna
Diagonal divider
Schrägfachablage

Przegrody wzdłużne i poprzeczne
Lengthwise and cross dividers
Querunterteiler

Rama na teczki zawieszane
Hanging files
Hängeregistratur



Od 1991 roku inwestujemy w jakość i najnowocześniejsze technologie. Dzięki wysoko wykwalifikowanej kadrze w efektywnych procesach przemysłowych realizujemy zlecenia pojedyncze i wielostanowiskowe. Kojarzona z marką premium fabryka MARO m.in. jako pierwsza w Polsce wprowadziła technologię laserową i jako pierwsza wdrożyła normy ISO 9001.

Since 1991 we are constantly investing in quality and cutting-edge technology. With the best machines and highly qualified staff we are able to make the production process very efficient to carry out both large contracts and individual orders smoothly and perfectly. MARO had pioneered in Poland the use of laser technology and was the first to meet strict requirements of quality management standards ISO 9001.

Seit dem Jahr 1991 investieren wir in Qualität und modernste Technologie. Mit den besten Maschinen und hochqualifizierten Mitarbeiter sind wir in der Lage die Produktionsprozesse sehr effizient zu gestalten, um sowohl Großausführungen als auch Einzelausführungen perfekt durchzuführen. MARO ist Pionier bei der Einführung der Lasertechnologie in Polen und hat auch als Erster die strenge Anforderungen der Qualitätsmanagementnormen ISO 9001 erfüllt.

Osiągnięcia
Leistungen
Achievements



1996, 1997, 1999,
2001, 2003, 2004



Wielki Złoty Medal 2004



1995, 1996, 1999, 2000



Pełna oferta
Current collection
Aktuelles Angebot



www.maro.com.pl

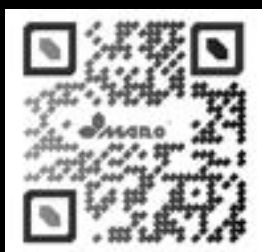

www.maro.com.pl



Wielkopolski
Filar Biznesu - 2002, 2007



Lider
Przedsiębiorczości - 2005



1998, 1999



2008, 2009



Fabryka Mebli Biurowych MARO
PL 62-052 Komorniki, ul. Fabianowska 100
T: +48 61 890 00 00, F: +48 61 890 00 90
www.maro.com.pl, E: maro@maro.com.pl

Dystrybutor

Niniejsza publikacja nie stanowi oferty w rozumieniu prawnym. MARO zastrzega sobie prawo wprowadzania zmian w oferowanych meblach. Prezentowane kolory mogą odbiegać od rzeczywistości. This publication does not constitute a legally binding agreement. MARO reserves the right to change product specifications at any time without prior notice. The colours represented in this publication may vary from the actual ones. Die unten aufgeführte Publikation ist nicht ein Angebot im rechtlichen Sinne. MARO behält sich das Recht vor, den Produktangebot zu verändern, jeder Zeit gegen ihrer endgültigen Entscheidung, auch ohne früherer Ankündigung. Die auf den Abbildungen zu ersehene Farbkoloristik kann von der originalen Färbung abweichen.

Wszystkie wzory chronione w Urzędzie Patentowym RP

© MARO