

OPIS TECHNICZNY

Błat roboczy

plyta melaminowana
28mm

Błat górny

szkło bezpieczne
9mm

Front

połączenie elementu metalowego
malowanego proszkowo z plexiglas

Oświetlenie

RGB LED -16 kolorów, sterowane radiowo
lub
Świetłówki jarzeniowe ("W" na końcu symbolu np. LZ016W)

Roczna gwarancja na oświetlenie.

Korpus

plyta melaminowana
18mm

Panel boczny

plyta melaminowana
28mm

Noga

plyta melaminowana
28mm

Półki

plyta melaminowana
18mm

Wieniec górny

plyta melaminowana 28mm
front PVC 2mm
boki PVC 0,5mm

Szuflada

plyta melaminowana 12mm
PVC 2mm

Boki

plyta melaminowana
28mm

Front

drzwi przesuwne zamocowane
na metalowym mechanizmie
z samodomykiem

ZS01

plyta melaminowana 12mm
pokryta laminatem HPL

Połączenie elementu metalowego
malowanego proszkowo z laminatem HPL

WYMIARY

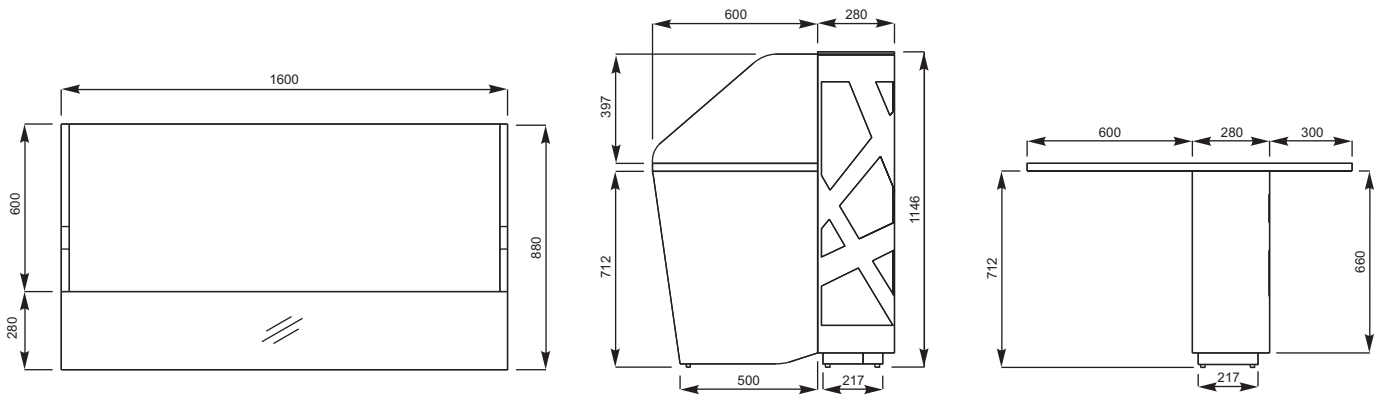

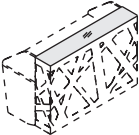
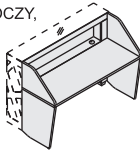
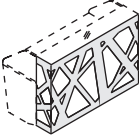
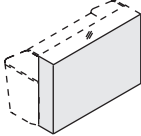
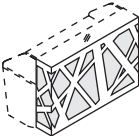

KOLORYSTYKA

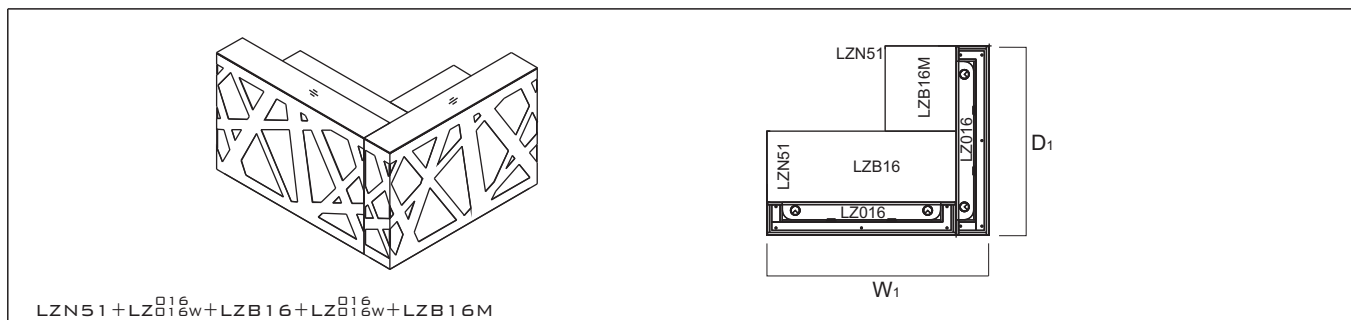
BLAT GÓRNY		SZKŁO BEZPIECZNE	
KORPUS, BLAT ROBOCZY, PANELE BOCZNE		67-BIAŁY PASTEL	
FRONT: METAL		15-BIAŁY POŁYSK	FRONT PŁYTA MELAMINOWANA
			
FRONT: PLEKSIGLAS		BIAŁY	
			67-BIAŁY PASTEL



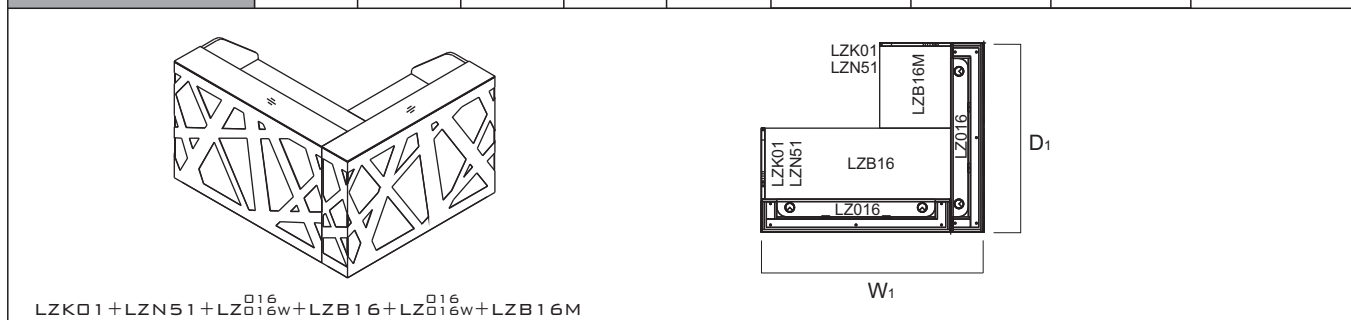

LZN51+LZ⁰¹⁶_{16w}+LZB16+LZ⁰¹⁶_{16w}+LZB16M

INDEX / SYMBOL	WYMIARY (mm)								UWAGI
	W ₁	W ₂	D ₁	D ₂	H	kg	m ³	szt	
-	W ₁	W ₂	D ₁	D ₂	H	kg	m ³	szt	
LZ032	1880	-	1600	-	1146	237,4	2,381	10	
LZ032W	1880	-	1600	-	1146	239,4	2,381	10	



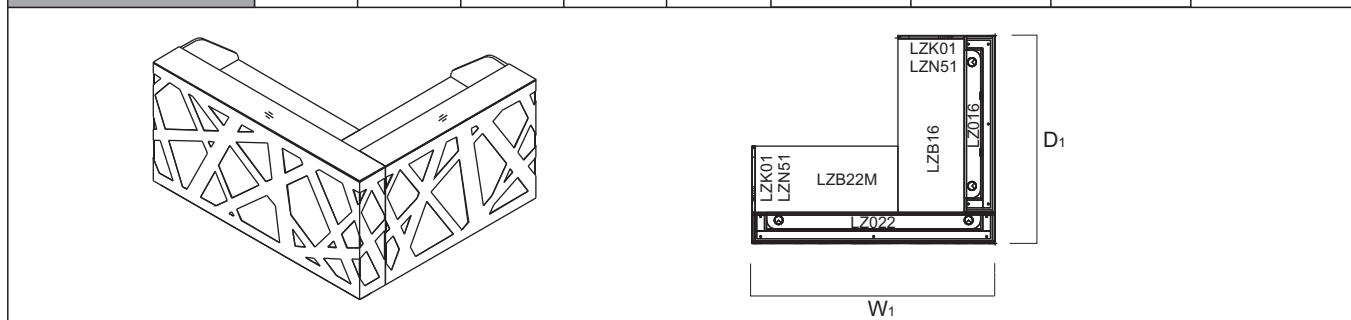

LZK01+LZN51+LZ⁰¹⁶_{16w}+LZB16+LZ⁰¹⁶_{16w}+LZB16M

INDEX / SYMBOL	WYMIARY (mm)								UWAGI
	W ₁	W ₂	D ₁	D ₂	H	kg	m ³	szt	
-	W ₁	W ₂	D ₁	D ₂	H	kg	m ³	szt	
LZ035	1880	-	1600	-	1146	244,1	2,4	11	
LZ035W	1880	-	1600	-	1146	246,1	2,4	11	



LZK01+LZN51+LZ⁰²²_{22w}+LZB22M+LZ⁰¹⁶_{16w}+LZB16

INDEX / SYMBOL	WYMIARY (mm)								UWAGI
	W ₁	W ₂	D ₁	D ₂	H	kg	m ³	szt	
-	W ₁	W ₂	D ₁	D ₂	H	kg	m ³	szt	
LZ036	2200	-	1880	-	1146	262,4	2,794	11	
LZ036W	2200	-	1880	-	1146	265,4	2,794	11	



INDEX „W” : oświetlenie jarzeniowe, białe np. LZ032W

LEGENDA:

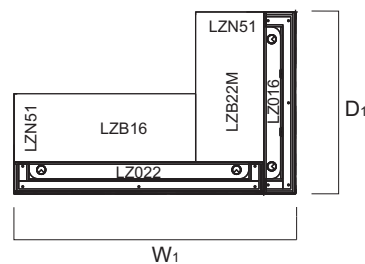
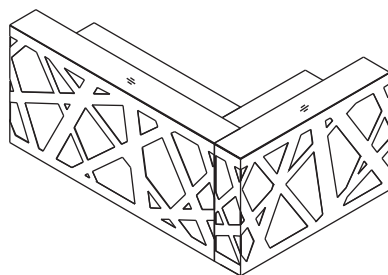
 - WAGA NETTO  - OBJĘTOŚĆ  - ILOŚĆ PACZEK



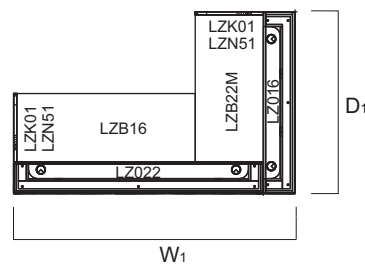
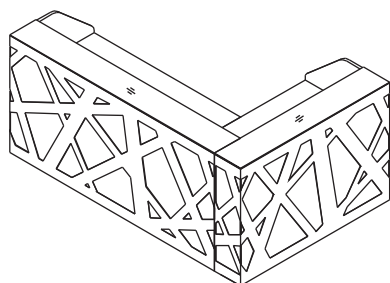

LZN51+LZ022w+LZB16+LZ016w+LZB22M

INDEX / SYMBOL	WYMIARY (mm)								UWAGI
	W ₁	W ₂	D ₁	D ₂	H				
-	W ₁	W ₂	D ₁	D ₂	H	kg	m ³	szt	
LZ038	2480	-	1600	-	1146	255,8	2,774	10	
LZ038W	2480	-	1600	-	1146	258,8	2,774	10	



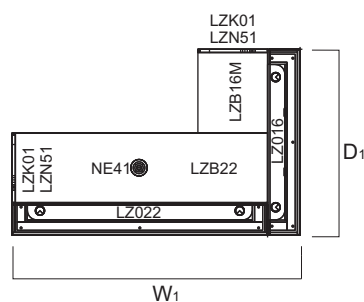
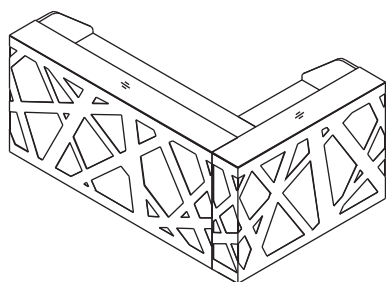

LZK01+LZN51+LZ022w+LZB16+LZ016w+LZB22M

INDEX / SYMBOL	WYMIARY (mm)								UWAGI
	W ₁	W ₂	D ₁	D ₂	H				
-	W ₁	W ₂	D ₁	D ₂	H	kg	m ³	szt	
LZ040	2480	-	1600	-	1146	262,4	2,794	11	
LZ040W	2480	-	1600	-	1146	265,4	2,794	11	



LZK01+LZN51+LZ022w+LZB22+NE41+LZ016w+LZB16M

INDEX / SYMBOL	WYMIARY (mm)								UWAGI
	W ₁	W ₂	D ₁	D ₂	H				
-	W ₁	W ₂	D ₁	D ₂	H	kg	m ³	szt	
LZ042	2480	-	1600	-	1146	261,8	2,798	9	
LZ042W	2480	-	1600	-	1146	264,8	2,798	9	

INDEX „W”: oświetlenie jarzeniowe, białe np. LZ032W

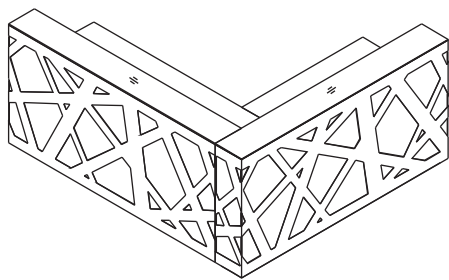

LEGENDA:

 - WAGA NETTO  - OBJĘTOŚĆ  - ILOŚĆ PACZEK

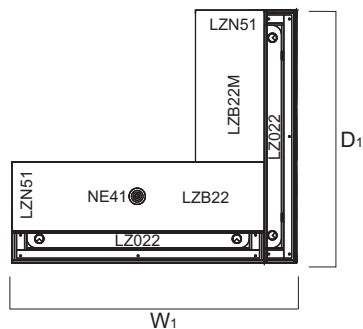

LZN51+LZ⁰²²₀₂₂w+LZB22+NE41+LZ⁰²²₀₂₂w+LZB22M



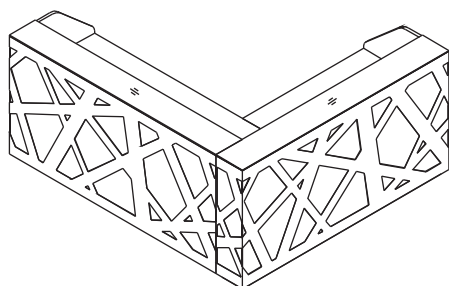

INDEX / SYMBOL	WYMIARY (mm)								UWAGI
	W ₁	W ₂	D ₁	D ₂	H				
-	W ₁	W ₂	D ₁	D ₂	H	kg	m ³	szt	
LZ044	2480	-	2200	-	1146	274,9	3,156	11	
LZ044W	2480	-	2200	-	1146	280,2	3,173	12	

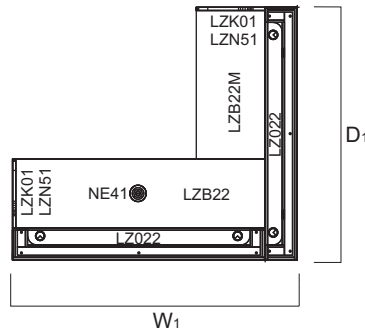

LZK01+LZN51+LZ⁰²²₀₂₂w+LZB22+NE41+LZ⁰²²₀₂₂w+LZB22M



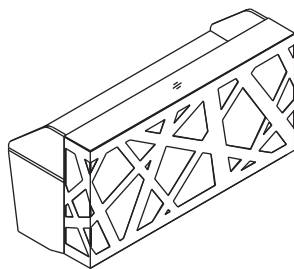

INDEX / SYMBOL	WYMIARY (mm)								UWAGI
	W ₁	W ₂	D ₁	D ₂	H				
-	W ₁	W ₂	D ₁	D ₂	H	kg	m ³	szt	
LZ045	2480	-	2200	-	1146	282,8	3,192	13	
LZ045W	2480	-	2200	-	1146	286,2	3,192	13	

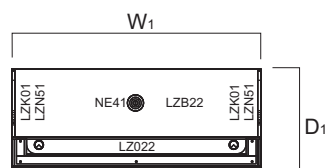

LZK01+LZN51+LZ⁰¹⁶₀₁₆w+LZB16 (1600MM)
LZK01+LZN51+LZ⁰²²₀₂₂w+LZB22+NE41 (2200MM)



INDEX / SYMBOL	WYMIARY (mm)								UWAGI
	W ₁	W ₂	D ₁	D ₂	H				
-	W ₁	W ₂	D ₁	D ₂	H	kg	m ³	szt	
LZ034	1600	-	880	-	1146	135,8	1,242	6	
LZ034W	1600	-	880	-	1146	136,8	1,242	6	
LZ046	2200	-	880	-	1146	155,5	1,641	7	
LZ046W	2200	-	880	-	1146	157,5	1,641	7	



INDEX „W” : oświetlenie jarzeniowe, białe np. LZ032W

LEGENDA:

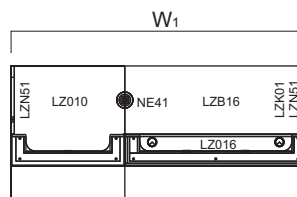
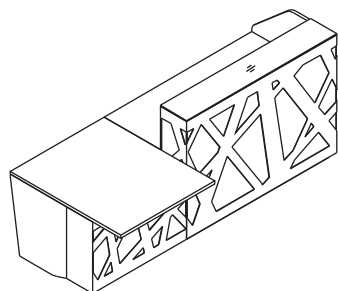
 - WAGA NETTO  - OBJĘTOŚĆ  - ILOŚĆ PACZEK



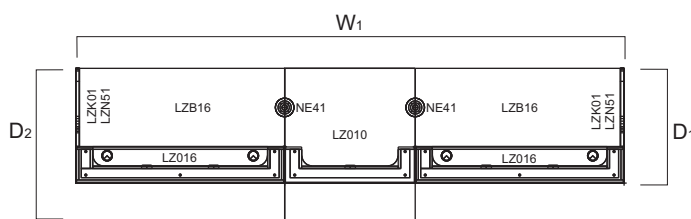
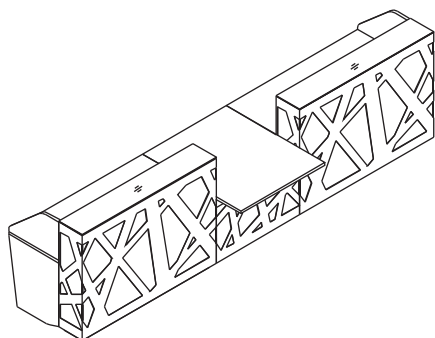

LZNS1+LZ010w+NE41+LZ016w+LZB16+LZK01 (2600MM)
 LZNS1+LZ010w+NE41+LZ022w+LZB22+NE41+LZK01 (3200MM)

INDEX / SYMBOL	WYMIARY (mm)								UWAGI
	W ₁	W ₂	D ₁	D ₂	H	kg	m ³	szt	
LZ050	2600	-	880	1180	1146	216,9	1,808	9	
LZ050W	2600	-	880	1180	1146	218,9	1,808	9	
LZ051	3200	-	880	1180	1146	235,3	2,19	9	
LZ051W	3200	-	880	1180	1146	238,3	2,19	9	



LZK01+LZNS1+LZ016w+LZB16+NE41+LZ010w+NE41+LZ016w+LZB16 (4200MM)
 LZK01+LZNS1+LZ016w+LZB16+NE41+LZ010w+NE41+LZ022w+LZB22+NE41 (4800MM)
 LZK01+LZNS1+LZ022w+LZB22+NE41+NE41+LZ010w+NE41+LZ022w+LZB22+NE41 (5400MM)

INDEX / SYMBOL	WYMIARY (mm)								UWAGI
	W ₁	W ₂	D ₁	D ₂	H	kg	m ³	szt	
LZ052	4200	-	880	1180	1146	332,9	3,014	14	
LZ052W	4200	-	880	1180	1146	335,9	3,014	14	
LZ053	4800	-	880	1180	1146	352,6	3,412	15	
LZ053W	4800	-	880	1180	1146	356,2	3,412	15	
LZ054	5400	-	880	1180	1146	372,3	3,81	16	
LZ054W	5400	-	880	1180	1146	377,3	3,81	16	



INDEX „W”: oświetlenie jarzeniowe, białe np. LZ032W

LEGENDA:

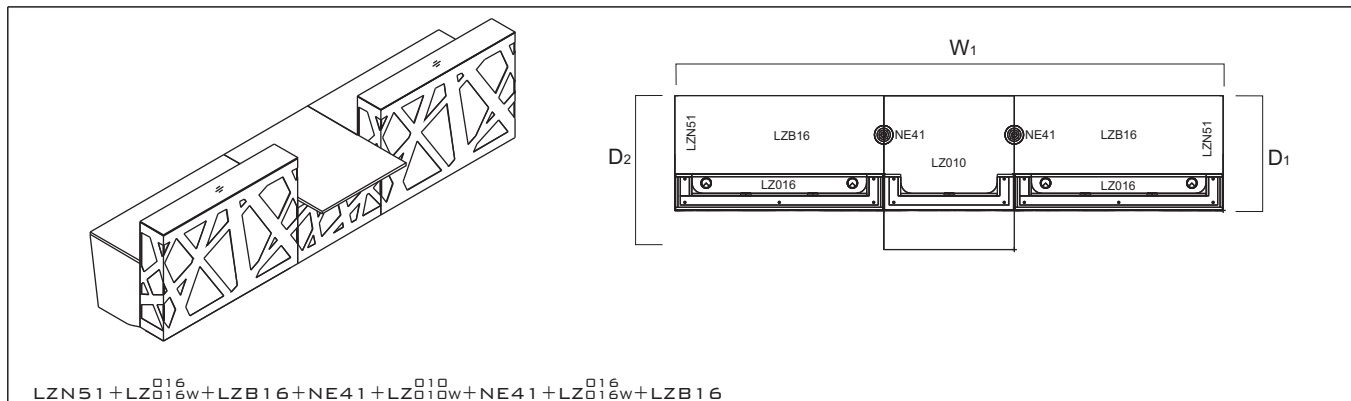
 - WAGA NETTO  - OBJĘTOŚĆ  - ILOŚĆ PACZEK



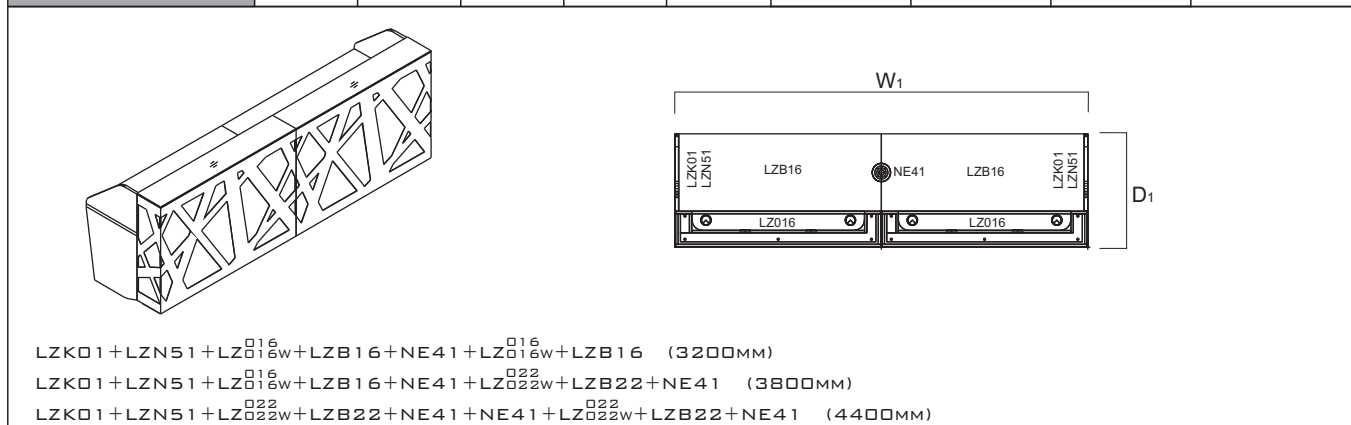

LZN51+LZ016w+LZB16+NE41+LZ010w+NE41+LZ016w+LZB16

INDEX / SYMBOL	WYMIARY (mm)								UWAGI
	W ₁	W ₂	D ₁	D ₂	H				
-	W ₁	W ₂	D ₁	D ₂	H	kg	m ³	szt	
LZ055	4200	-	880	1180	1146	326,3	2,994	13	
LZ055W	4200	-	880	1180	1146	329,3	2,994	13	



LZK01+LZN51+LZ016w+LZB16+NE41+LZ016w+LZB16 (3200MM)
 LZK01+LZN51+LZ016w+LZB16+NE41+LZ022w+LZB22+NE41 (3800MM)
 LZK01+LZN51+LZ022w+LZB22+NE41+NE41+LZ022w+LZB22+NE41 (4400MM)

INDEX / SYMBOL	WYMIARY (mm)								UWAGI
	W ₁	W ₂	D ₁	D ₂	H				
-	W ₁	W ₂	D ₁	D ₂	H	kg	m ³	szt	
LZ060	3200	-	880	-	1146	251,9	2,448	11	
LZ060W	3200	-	880	-	1146	253,9	2,448	11	
LZ061	3800	-	880	-	1146	271,6	2,846	12	
LZ061W	3800	-	880	-	1146	274,6	2,846	12	
LZ062	4400	-	880	-	1146	291,3	3,245	13	
LZ062W	4400	-	880	-	1146	295,3	3,245	13	



INDEX „W” : oświetlenie jarzeniowe, białe np. LZ032W

LEGENDA:

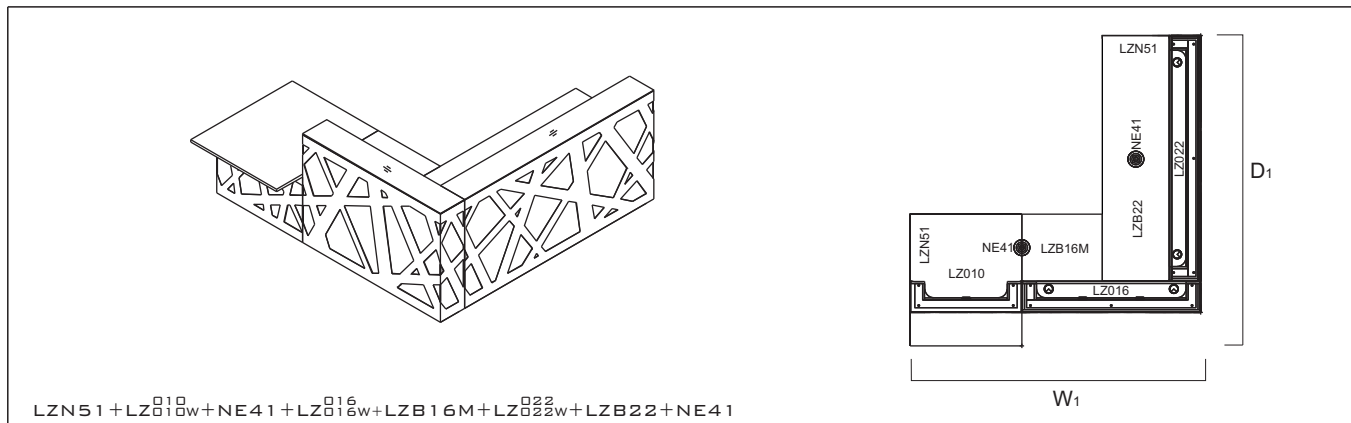
 - WAGA NETTO  - OBJĘTOŚĆ  - ILOŚĆ PACZEK



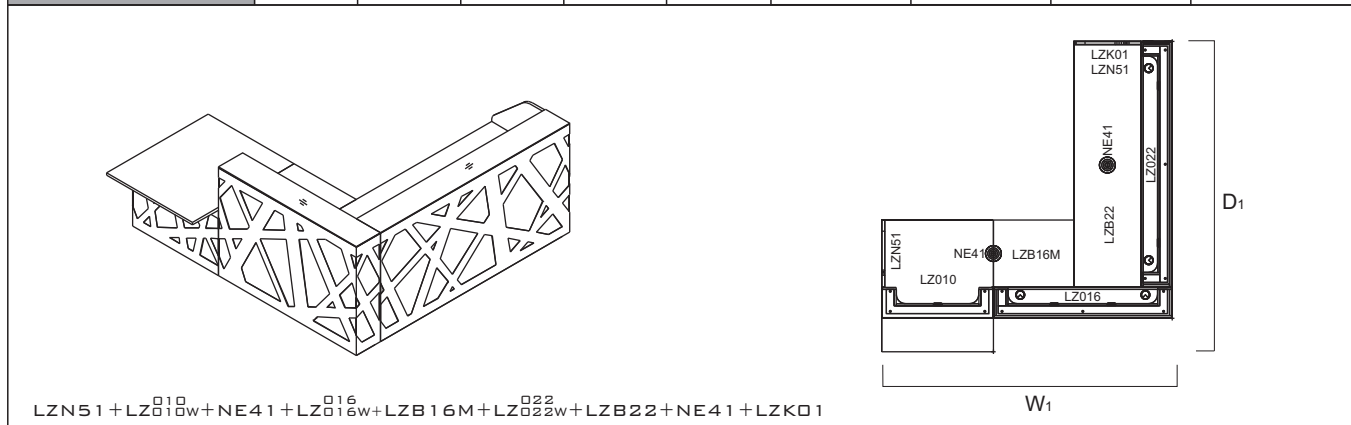

LZN51+LZ010w+NE41+LZ016w+LZB16M+LZ022w+LZB22+NE41

INDEX / SYMBOL	WYMIARY (mm)								UWAGI
	W ₁	W ₂	D ₁	D ₂	H	kg	m ³	szt	
LZ064	2600	-	2780	-	1146	337,5	3,344	13	
LZ064W	2600	-	2780	-	1146	341,5	3,344	13	



LZN51+LZ010w+NE41+LZ016w+LZB16M+LZ022w+LZB22+NE41+LZK01

INDEX / SYMBOL	WYMIARY (mm)								UWAGI
	W ₁	W ₂	D ₁	D ₂	H	kg	m ³	szt	
LZ063	2600	-	2780	-	1146	344,1	3,364	14	
LZ063W	2600	-	2780	-	1146	348,1	3,364	14	



INDEX „W” : oświetlenie jarzeniowe, białe np. LZ032W

LEGENDA:





 - WAGA NETTO

 - OBJĘTOŚĆ

 - ILOŚĆ PACZEK

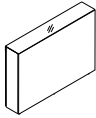
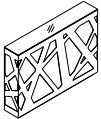
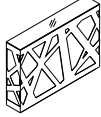
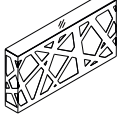
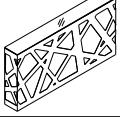
WIDOK OBIEKTU	WYMIARY (mm)			SYMBOL				UWAGI
	SZEROKOŚĆ	GŁĘBOKOŚĆ	WYSOKOŚĆ		kg	m ³	szt	



ELEMENTY SKŁADOWE

	1600	280	1146	LZ016M	87,8	1,14	1	- front: plyta melaminowana
	1600	280	1146	LZ016	90	1,14	1	- oświetlenie RGB LED
	1600	280	1146	LZ016W	103	1,14	1	- woświetlenie jarzeniowe -białe
	2200	280	1146	LZ022	115	1,52	1	- oświetlenie RGB LED
	2200	280	1146	LZ022W	115	1,52	1	- woświetlenie jarzeniowe -białe
	1000	1180	740	LZ010	82,7	0,549	2	- oświetlenie RGB LED
	1000	1180	740	LZ010W	83,7	0,549	2	- woświetlenie jarzeniowe -białe
	600	28	397	LZK01	6,6	0,019	1	- panel boczny
	600	28	712	LZN51	14,4	0,034	1	- noga płytowa



LEGENDA:
 - WAGA NETTO

 - OBJĘTOŚĆ

 - ILOŚĆ PACZEK

WIDOK OBIEKTU	WYMIARY (mm)			SYMBOL				UWAGI
	SZEROKOŚĆ	GŁĘBOKOŚĆ	WYSOKOŚĆ		kg	m ³	szt	

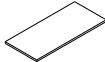
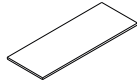
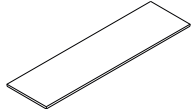
ELEMENTY SKŁADOWE

	720	600	28	LZB16M	9,7	0,017	3	- blat
	1320	600	28	LZB22M	17	0,03	4	- blat
	1600	600	28	LZB16	17	0,048	3	- blat
	2200	600	28	LZB22	23,7	0,049	3	- blat
	∅ 40	-	712	NE41	1,2	0,016	1	-noga podpierająca

AKCESORIA

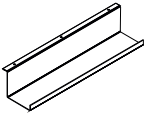
	140	70	750	S81	0,9	0,007	1	-przewodzenie kabli (kręgosłup) 09 - aluminium
	600	147	120	E26	2,8	0,014	1	- przewadnica kablowa

LEGENDA:
 - WAGA NETTO

 - OBJĘTOŚĆ

 - ILOŚĆ PACZEK