











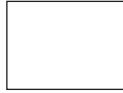
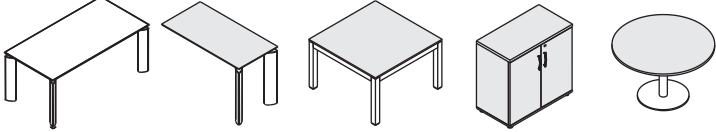

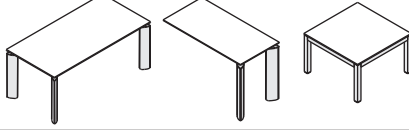

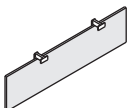

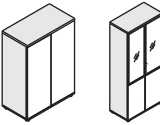













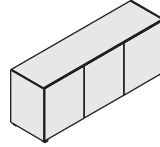

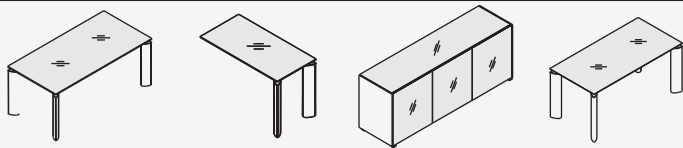

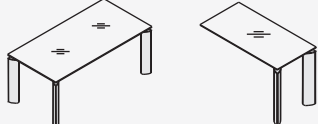

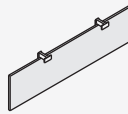

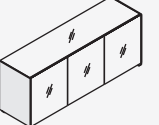

## CRYSTAL - PŁYTA MELAMINOWANA

 31-DĄB KANADYJSKI	 34-KASZTAN	 67-BIAŁY PASTEL	
 15-METAL BIAŁY POŁYSK	 08-METAL CZARNY		
 67-BIAŁY PASTEL	 08-CZARNY		
 67-BIAŁY PASTEL			FRONT HPL: 101-CZARNY POŁYSK WIENIEC GÓRNY I KORPUS: 08-CZARNY
 67-BIAŁY PASTEL	 08-CZARNY		FRONT I WIENIEC GÓRNY HPL: 73-BIAŁY POŁYSK KORPUS: 67-BIAŁY PASTEL
 67-BIAŁY PASTEL	 08-CZARNY		FRONT I WIENIEC GÓRNY HPL: 101-CZARNY POŁYSK KORPUS: 08-CZARNY
 72-ZIELONY POŁYSK	 73-BIAŁY POŁYSK	 74-POMARAŃCZOWY POŁYSK	 82-CZERWONY POŁYSK
 31-DĄB KANADYJSKI	 34-KASZTAN		

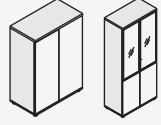
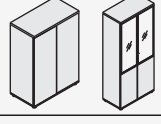
## CRYSTAL - SZKŁO

 117-SZKŁO BIAŁE	 116-SZKŁO CZARNE	
 15-METAL BIAŁY POŁYSK	 08-METAL CZARNY	
 67-BIAŁY PASTEL	 08-CZARNY	
 67-BIAŁY PASTEL	 08-CZARNY	
 67-BIAŁY PASTEL	 08-CZARNY	
 67-BIAŁY PASTEL	 08-CZARNY	
 67-BIAŁY PASTEL	 08-CZARNY	
 72-ZIELONY POŁYSK	 73-BIAŁY POŁYSK	 74-POMARAŃCZOWY POŁYSK
 82-CZERWONY POŁYSK	 82-CZERWONY POŁYSK	

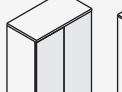
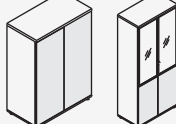
## OPIS TECHNICZNY

### Zastosowane materiały:

- szkło satynowane, hartowane, ultra clear (dla białego)
- profil aluminiowy anodowany, malowany proszkowo

### BIURKO, STÓŁ KONFERENCYJNY

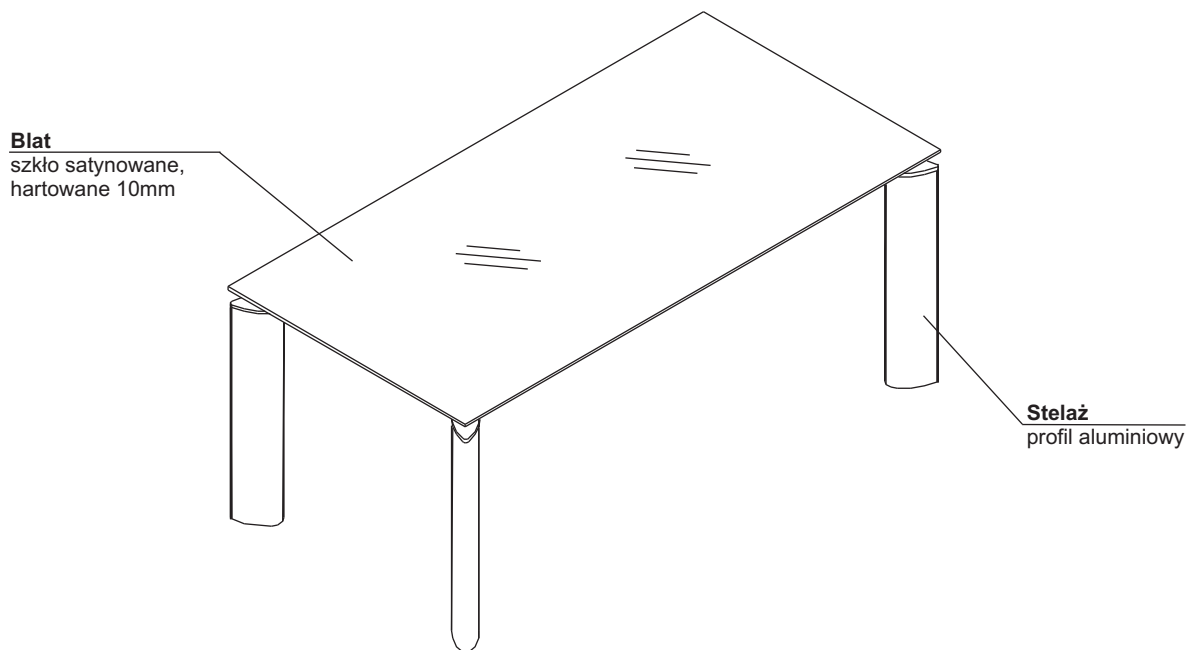

### PRYZYSTAWKA

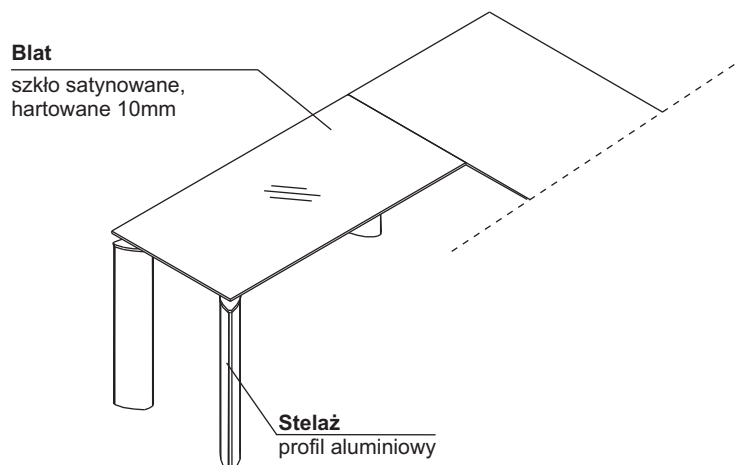

### BLENDY

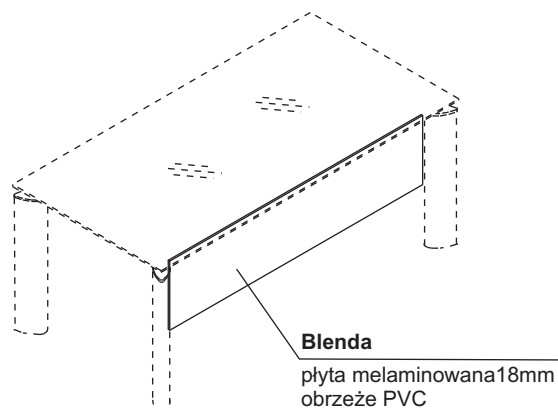

## OPIS TECHNICZNY SZAFY

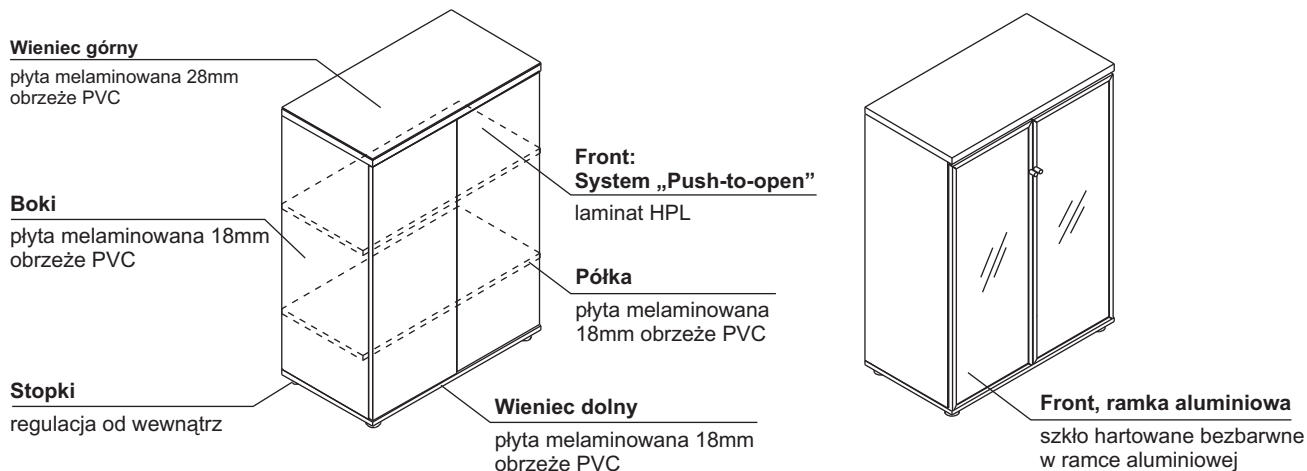

## KOMODA ZE SZKŁEM

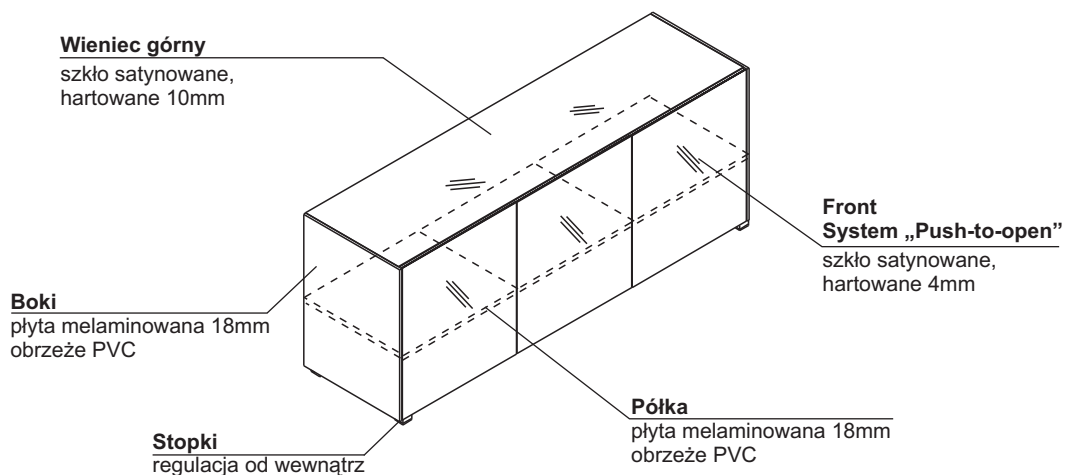

## KONTENER SLK13HT

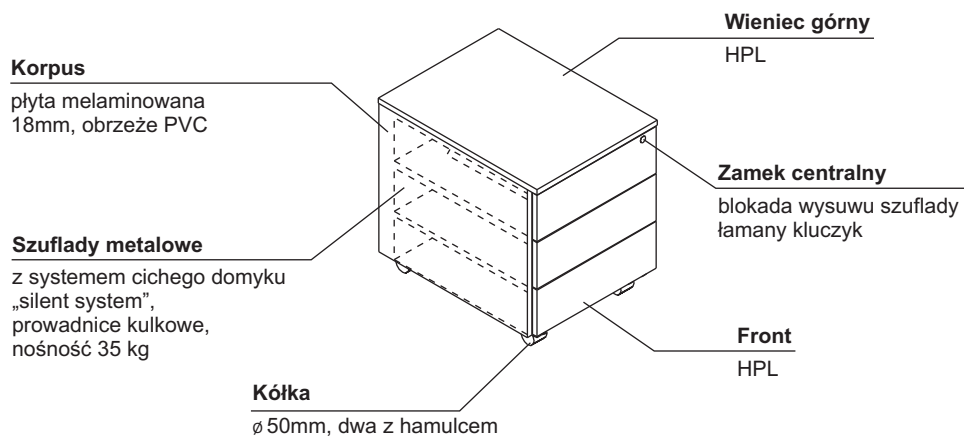

## KOLORYSTYKA

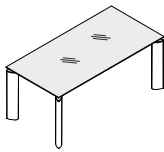
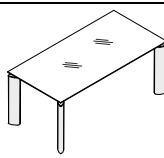
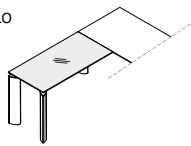
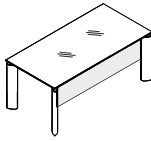
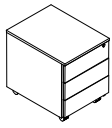
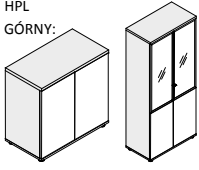
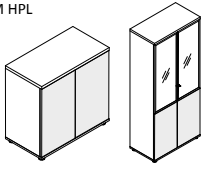
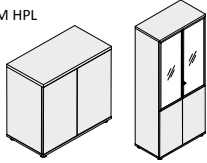
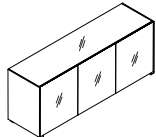
<p>BLAT – SZKŁO</p> 	<p>117 – SZKŁO BIAŁE 116 – SZKŁO CZARNE</p>
<p>STELAŻ</p> 	<p>15 – METAL BIAŁY POŁYSK 08 – METAL CZARNY</p>
<p>PRZYSTAWKA - SZKŁO</p> 	<p>117 – SZKŁO BIAŁE 116 – SZKŁO CZARNE</p>
<p>OSŁONA, STOLIK OKRĄGŁY</p> 	<p>67 – BIAŁY PASTEL 08 – CZARNY</p>
<p>KONTENER SLK13HT</p> 	<p>FRONT WINIEC GÓRNY HPL: 73 - BIAŁY POŁYSK      FRONT I WINIEC GÓRNY HPL: 101 - CZARNY POŁYSK KORPUS: 67 - BIAŁY PASTEL      KORPUS: 08 - CZARNY</p>
<p>SZAFA Z FRONTEM HPL KORPUS I WINIEC GÓRNY:</p> 	<p>67 – BIAŁY PASTEL</p>
<p>SZAFA Z FRONTEM HPL FRONT:</p> 	<p>72 - ZIELONY POŁYSK 73 - BIAŁY POŁYSK 74 - POMARAŃCZOWY POŁYSK 82 - CZERWONY POŁYSK</p>
<p>SZAFA Z FRONTEM HPL</p> 	<p>FRONT - HPL: 101 - CZARNY POŁYSK WINIEC GÓRNY I KORPUS: 08 - CZARNY</p>
<p>KOMODA ZE SZKŁEM</p> 	<p>FRONT: 117 - SZKŁO BIAŁE      FRONT: 116 - SZKŁO CZARNE WINIEC GÓRNY I KORPUS: 67 - BIAŁY PASTEL      WINIEC GÓRNY I KORPUS: 08 - CZARNY</p>

WIDOK I RZUT OBIEKTU	WYMIARY (mm)			SYMBOL	UWAGI
	Szerokość a / a'	Głębokość b / b'	Wysokość h		

### BIURKA Z BLATEM SZKLANYM

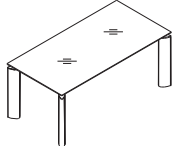
	1600	800	760	<b>AE4S</b>	
	1800	900	760	<b>AE5S</b>	
	2000	900	760	<b>AE6S</b>	

### OSŁONY PŁYTOWE DO BIUREK

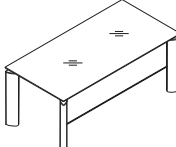
	1400	18	350	<b>AE4B</b>	
	1600	18	350	<b>AE5B</b>	
	1800	18	350	<b>AE6B</b>	

### PRZYSTAWKA DO BIURKA Z BLATEM SZKLANYM

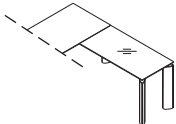
	1200	600	760	<b>AE7S</b>	
---	------	-----	-----	-------------	--

### KONTENER MOBILNY Z WIĘNCEM GÓRNYM I FRONTEM HPL

	470	616	580	<b>SLK13HT</b>	- płyta melaminowana Front i wieńiec górny HPL
--	-----	-----	-----	----------------	---

### KOMODA ZE SZKŁEM

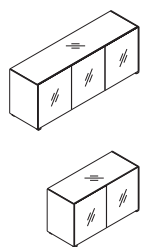
	2000	432	740	<b>AE20S</b>	- wieńiec górny i drzwi szkło
	1334	432	740	<b>AE21S</b>	- wieńiec górny i drzwi szkło

### STÓŁ KONFERENCYJNY Z BLATEM SZKLANYM

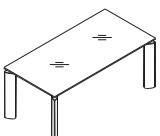



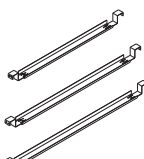

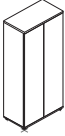

	2200	1100	760	<b>AE11S</b>	
---	------	------	-----	--------------	--

### KANAŁY KABLOWE

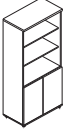



	1496	85	94	<b>EK1200</b>	- do biurka 1600mm
	1696	85	94	<b>EK1400</b>	- do biurka 1800mm
	1896	85	94	<b>EK1600</b>	- do biurka 2000mm

WIDOK I RZUT OBIEKTU	WYMIARY (mm)			SYMBOL
	Szerokość a / a'	Głębokość b / b'	Wysokość h	

## SZAFY Z FRONTEM HPL

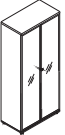
 	802	432	1833	<b>A5104H</b>
 	802	432	1833	<b>A5404H</b>
 	802	432	1129	<b>A3104H</b>
 	802	432	1129	<b>A3404H</b>
 	802	432	777	<b>A2104H</b>

## WITRYNY

- drzwi szklane w ramce aluminiowej  	802	432	1833	<b>A5104W</b>
- drzwi szklane w ramce aluminiowej - drzwi płytowe: system „Push-to-open” z frontem HPL  	802	432	1833	<b>A5404W</b>
- drzwi szklane w ramce aluminiowej  	802	432	1129	<b>A3104W</b>



Szafy nie posiadają zamka.

## OPIS TECHNICZNY

### Zastosowane materiały:

- płyta melaminowana
- profil aluminiowy anodowany, malowany proszkowo

## BIURKO, STÓŁ KONFERENCYJNY

### Blat

płyta melaminowana 12mm  
obrzeże PVC

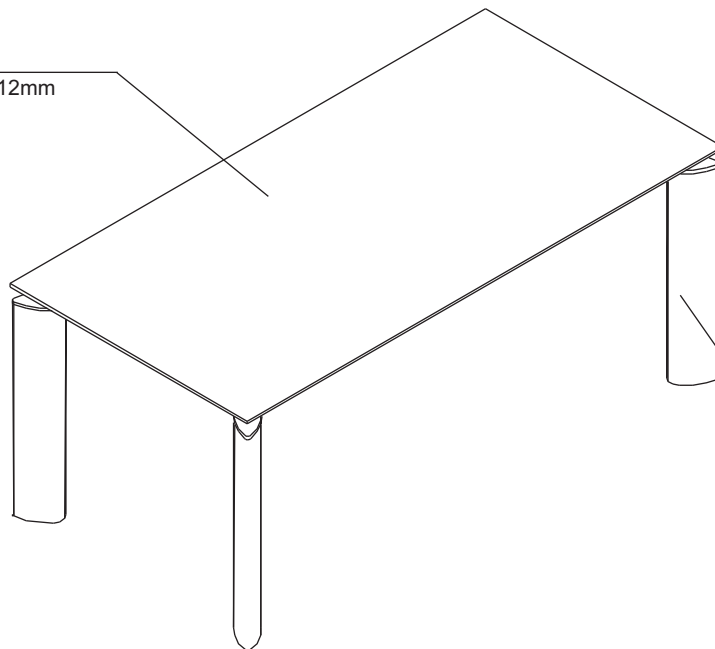

### Stelaż

profil aluminiowy

## PRYZYSTAWKA

### Blat

płyta melaminowana 12mm  
obrzeże PVC

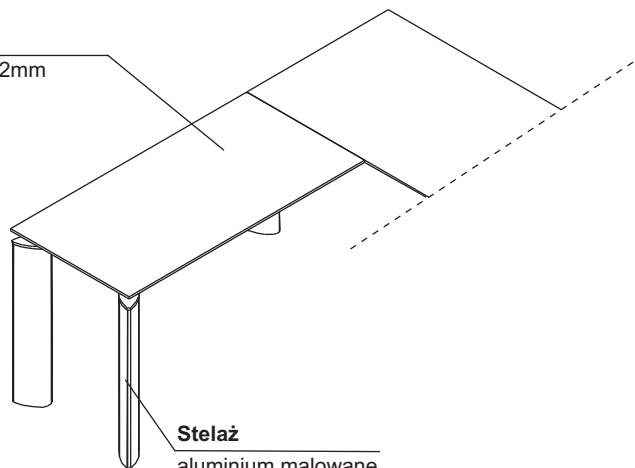

### Stelaż

aluminium malowane  
proszkowo

## BLENDY

### Blenda

płyta melaminowana 18mm  
obrzeże PVC

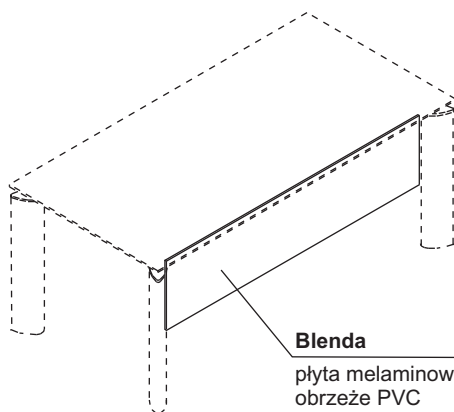

## OPIS TECHNICZNY SZAFY

### Wieniec górny

plyta melaminowana 28mm  
obrzeże PVC

### Boki

plyta melaminowana 18mm  
obrzeże PVC

### Stopki

regulacja od wewnątrz

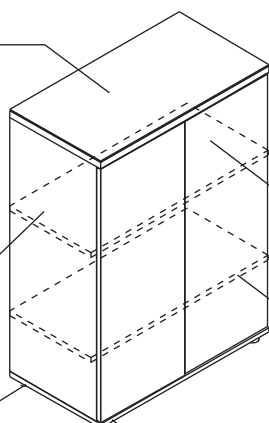

**Front:**  
**System „Push-to-open”**  
laminat HPL

### Półka

plyta melaminowana  
18mm obrzeże PVC

### Wieniec dolny

plyta melaminowana 18mm  
obrzeże PVC

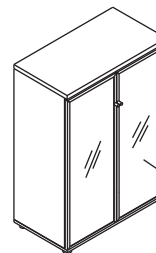

### Front, ramka aluminiowa

szkło hartowane, bezbarwne  
w ramce aluminiowej

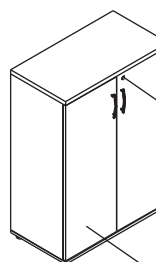

### Zamek patentowy

### Front

plyta melaminowana  
18mm, obrzeże PVC

## KOMODA ZE SZKŁEM

### Wieniec górny

plyta melaminowana 12mm,  
obrzeże PVC

### Boki

plyta melaminowana 18mm  
obrzeże PVC

### Stopki

regulacja od wewnątrz

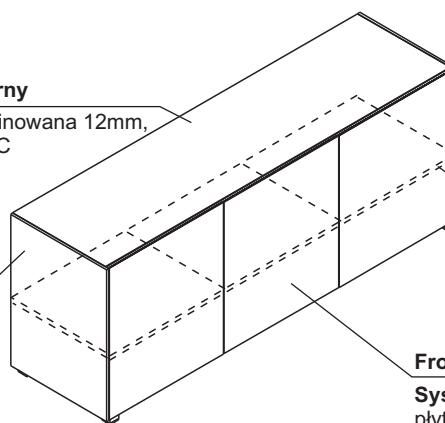

### Półka

plyta melaminowana 18mm  
obrzeże PVC

### Front

**System „Push-to-open”**  
plyta melaminowana 18mm  
obrzeże PVC

## KONTENER SLK13HT

### Korpus

plyta melaminowana  
18mm, obrzeże PVC

### Szuflady metalowe

z systemem cichego domyku  
„silent system”,  
prowadnice kulkowe,  
nośność 35 kg

### Kółka

ø 50mm, dwa z hamulcem

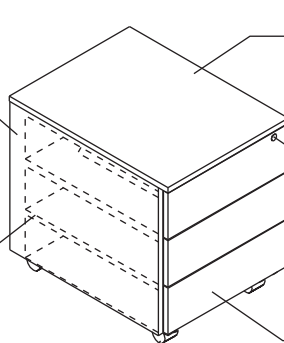

### Wieniec górny

HPL

### Zamek centralny

blokada wysuwu szuflady  
łamany klucz

### Front

HPL

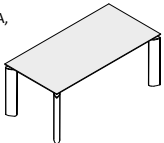
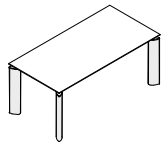
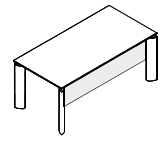
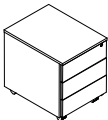
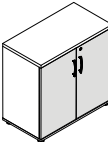
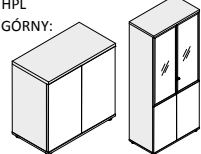
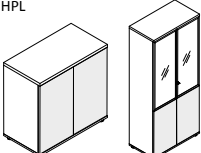
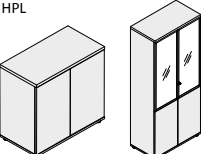
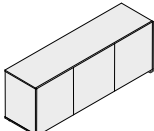

## KOLORYSTYKA

<p>BLAT, PRZYSTAWKA,</p> 	<p>31 – DĄB KANADYJSKI 34 – KASZTAN 67 – BIAŁY PASTEL</p>
<p>STELAŻ</p> 	<p>15 – METAL BIAŁY POŁYSK 08 – METAL CZARNY</p>
<p>OSŁONA</p> 	<p>67 – BIAŁY PASTEL 08 – CZARNY</p>
<p>KONTENER HPL SLK13HT</p> 	<p>FRONT I WIENIEC GÓRNY HPL: 73 - BIAŁY POŁYSK      FRONT I WIENIEC GÓRNY HPL: 101 - CZARNY POŁYSK  KORPUS: 67 - BIAŁY PASTEL      KORPUS: 08 - CZARNY</p>
<p>FRONT, WIENIEC GÓRNY, KORPUS</p> 	<p>31 – DĄB KANADYJSKI 34 – KASZTAN 67 – BIAŁY PASTEL</p>
<p>SZAFA Z FRONTEM HPL KORPUS I WIENIEC GÓRNY:</p> 	<p>67 – BIAŁY PASTEL</p>
<p>SZAFA Z FRONTEM HPL FRONT:</p> 	<p>72 - ZIELONY POŁYSK 73 - BIAŁY POŁYSK 74 - POMARAŃCZOWY POŁYSK 82 - CZERWONY POŁYSK</p>
<p>SZAFA Z FRONTEM HPL</p> 	<p>FRONT - HPL: 101 - CZARNY POŁYSK  WIENIEC GÓRNY I KORPUS: 08 - CZARNY</p>
<p>KOMODA AE20</p> 	<p>31 – DĄB KANADYJSKI 34 – KASZTAN</p>

## KONFIGURACJA MEDIABOX M01: BIURKO Z BLATEM PŁYTOWYM

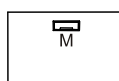

- możliwość usytuowania w jednym miejscu (M)
- opcję należy dopisać na końcu symbolu oraz doliczyć wartość mediabox M01 do ceny biurka:  
np. AE4M

## KONFIGURACJA MEDIABOX M01: STÓŁ KONFERENCYJNY Z BLATEM PŁYTOWYM

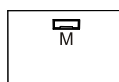

- możliwość usytuowania w jednym miejscu (M)
- opcję należy dopisać na końcu symbolu oraz doliczyć wartość mediabox M01 do ceny biurka:  
np. AE11M

WIDOK I RZUT OBIEKTU	WYMIARY (mm)			SYMBOL	UWAGI
	Szerokość a / a'	Głębokość b / b'	Wysokość h		

### BIURKA Z BLATEM PŁYTOWYM

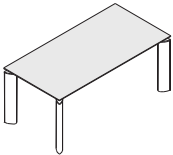
	1600	800	760	<b>AE4</b>	
	1800	900	760	<b>AE5</b>	
	2000	900	760	<b>AE6</b>	

### OSŁONY PŁYTOWE DO BIUREK

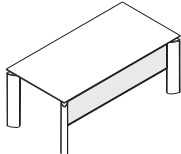
	1400	18	350	<b>AE4B</b>	
	1600	18	350	<b>AE5B</b>	
	1800	18	350	<b>AE6B</b>	

### PRZYSTAWKA DO BIURKA Z BLATEM PŁYTOWYM

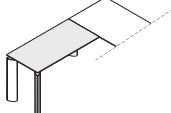
	1200	600	760	<b>AE7</b>	
---	------	-----	-----	------------	--

### KONTENER MOBILNY Z WIĘNCEM GÓRNYM I FRONTEM HPL

	470	616	580	<b>SLK13HT</b>	- płyta melaminowana Front i wieńiec górny HPL
--	-----	-----	-----	----------------	---

### KOMODA

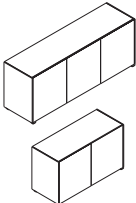
	2000	432	740	<b>AE20</b>	
	1334	432	740	<b>AE21</b>	

### STOLIK

- talerz: $\varnothing$ 620mm - kolumna: $\varnothing$ 100mm 	$\varnothing$ 1200	-	730	<b>ST12</b>	- talerz - stal nierdzewna - kolumna - malowana proszkowo, 15-biały, 115-czarny, 09-aluminium
--	--------------------	---	-----	-------------	--

### STÓŁ KONFERENCYJNY Z BLATEM PŁYTOWYM

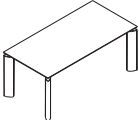
	2200	1100	760	<b>AE11</b>	
---	------	------	-----	-------------	--

### ELEMENTY DODATKOWE





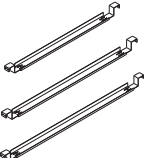

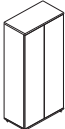

	300	110	110	<b>M01</b>	- 4 x 230V - 2 x RJ45 104-szary struktura - wyłącznie do blatów płytowych
---	-----	-----	-----	------------	--

### KANAŁY KABLOWE

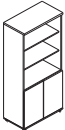



	1496	85	94	<b>EK1200</b>	- do biurka 1600mm
	1696	85	94	<b>EK1400</b>	- do biurka 1800mm
	1896	85	94	<b>EK1600</b>	- do biurka 2000mm

WIDOK I RZUT OBIEKTU	WYMIARY (mm)			SYMBOL
	Szerokość a / a'	Głębokość b / b'	Wysokość h	



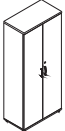
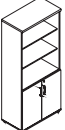

### SZAFY Z FRONTEM HPL

 	802	432	1833	<b>A5104H</b>
 	802	432	1833	<b>A5404H</b>
 	802	432	1129	<b>A3104H</b>
 	802	432	1129	<b>A3404H</b>
 	802	432	777	<b>A2104H</b>

### SZAFY

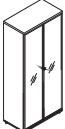
	802	432	1833	<b>A5104</b>
	802	432	1833	<b>A5404</b>
	802	432	1129	<b>A3104</b>
	802	432	1129	<b>A3504</b>
	802	432	777	<b>A2104</b>

### WITRYNY

- drzwi szklane w ramce aluminiowej  	802	432	1833	<b>A5104W</b>
- drzwi szklane w ramce aluminiowej - drzwi płytowe: system „Push-to-open” z frontem HPL  	802	432	1833	<b>A5404W</b>
- drzwi szklane w ramce aluminiowej  	802	432	1129	<b>A3104W</b>



Szafy nie posiadają zamka.