

## IMPULS - PŁYTA MELAMINOWANA

31-DĄB KANADYJSKI	34-KASZTAN	67-BIAŁY PASTEL	
15-METAL BIAŁY POŁYSK	08-METAL CZARNY		
67-BIAŁY PASTEL	08-CZARNY		
			<p>SLK13HT</p> <p>FRONT WIENIEC GÓRNY HPL: 73-BIAŁY POŁYSK</p> <p>KORPUS: 67-BIAŁY PASTEL</p> <p>FRONT I WIENIEC GÓRNY HPL: 101-CZARNY POŁYSK</p> <p>KORPUS: 08-CZARNY</p>
72-ZIEŁONY POŁYSK	73-BIAŁY POŁYSK	74-POMARAŃCZOWY POŁYSK	82-CZERWONY POŁYSK
67-BIAŁY PASTEL			
31-DĄB KANADYJSKI	34-KASZTAN		

## IMPULS - SZKŁO

117-SZKŁO BIAŁE	116-SZKŁO CZARNE	
15-METAL BIAŁY POŁYSK	08-METAL CZARNY	
67-BIAŁY PASTEL	08-CZARNY	
		<p>SLK13HT</p> <p>FRONT I WIENIEC GÓRNY HPL: 73-BIAŁY POŁYSK</p> <p>KORPUS: 67-BIAŁY PASTEL</p> <p>FRONT I WIENIEC GÓRNY HPL: 101-CZARNY POŁYSK</p> <p>KORPUS: 08-CZARNY</p>
		<p>FRONT HPL: 101-CZARNY POŁYSK</p> <p>WIENIEC GÓRNY I KORPUS: 08-CZARNY</p>

**OPIS TECHNICZNY**

**Zastosowane materiały:**

- szkło satynowane, hartowane ultra clear (dla białego)
- profil aluminiowy anodowany, malowany proszkowo, z detalami chromowanymi

**BIURKO, PRZYSTAWKA, STOLIKI, STÓŁ**

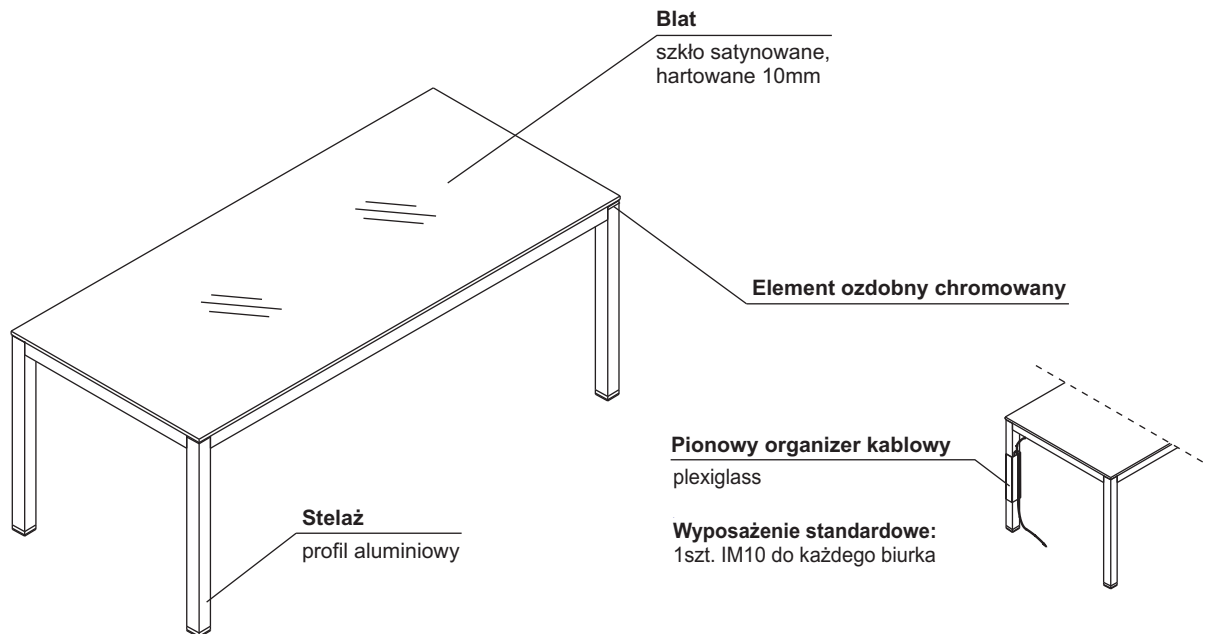

**BLENDY, PRZYSTAWKA**

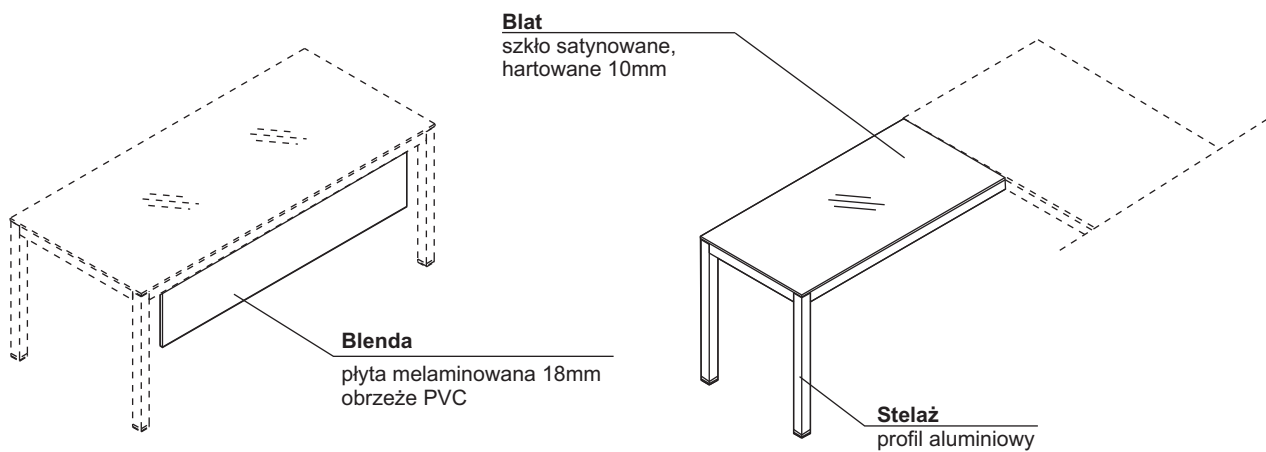

**STÓŁ KONFERENCYJNY**

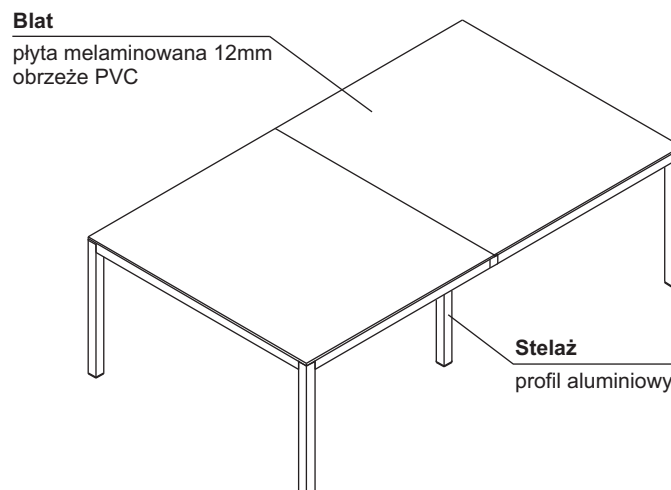

OPIS TECHNICZNY  
SZAFY

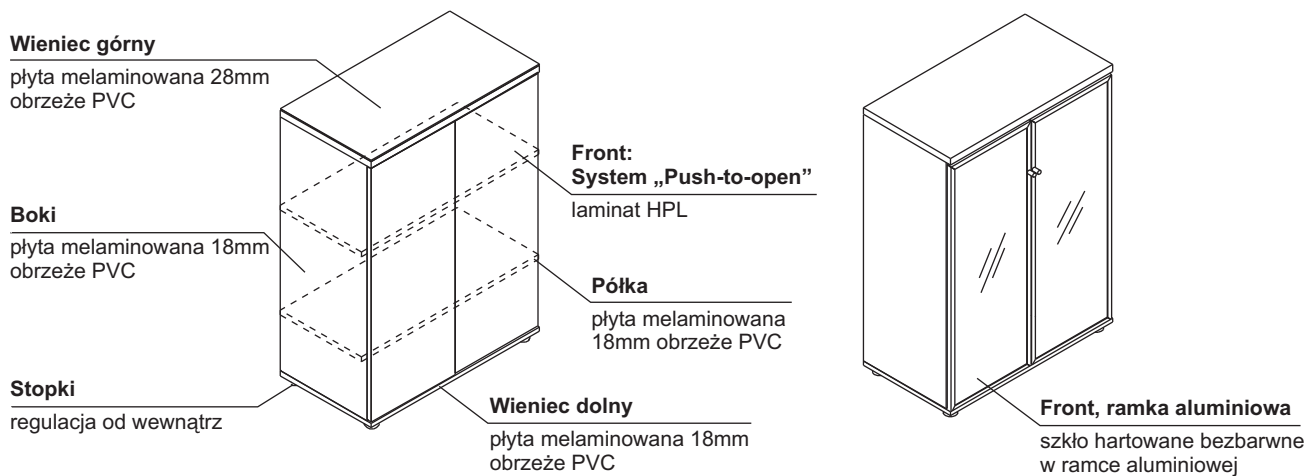

KOMODA ZE SZKŁEM

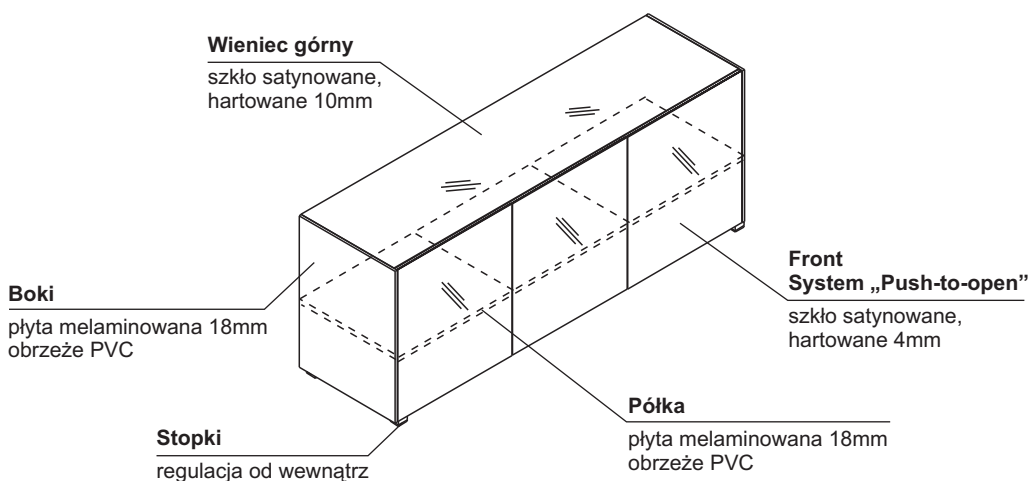

KONTENER SLK13HT

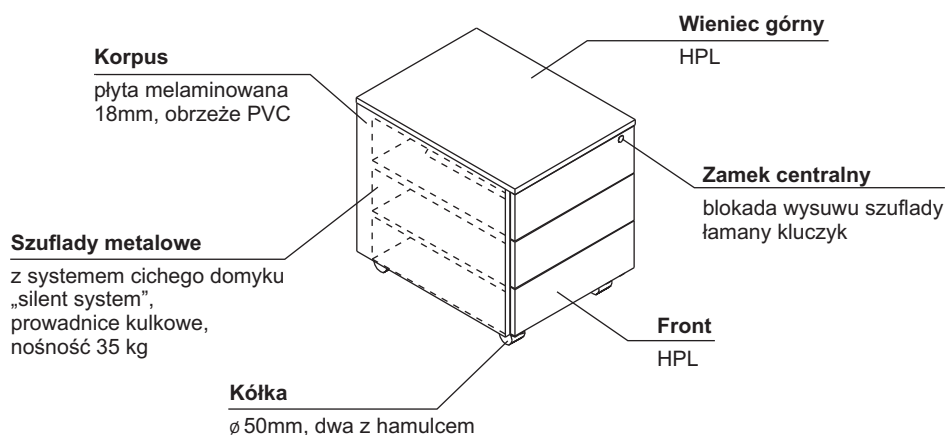

## KOLORYSTYKA

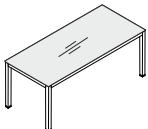
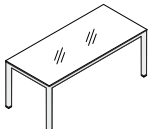
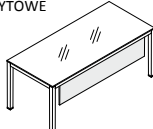
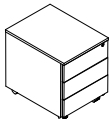
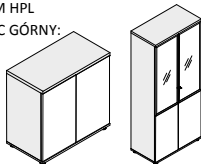
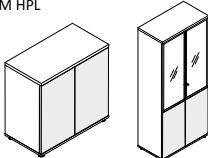
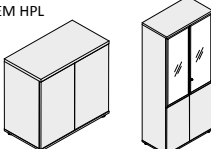
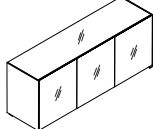
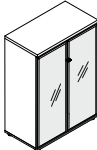
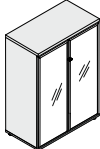
<p>BLATY SZKLANE</p> 	<p>117 – SZKŁO BIAŁE 116 – SZKŁO CZARNE</p>	
<p>STELAŻ</p> 	<p>15 – METAL BIAŁY POŁYSK 08 – METAL CZARNY</p>	
<p>OSŁONA, BLATY PŁYTOWE</p> 	<p>67 – BIAŁY PASTEL 08 – CZARNY</p>	
<p>KONTENER HPL SLK13HT</p> 	<p>FRONT I WIENIEC GÓRNY HPL: 73 - BIAŁY POŁYSK</p> <p>KORPUS: 67 - BIAŁY PASTEL</p>	<p>FRONT I WIENIEC GÓRNY HPL: 101 - CZARNY POŁYSK</p> <p>WIENIEC GÓRNY I KORPUS: 08 - CZARNY</p>
<p>SZAFA Z FRONTEM HPL KORPUS I WIENIEC GÓRNY:</p> 	<p>67 – BIAŁY PASTEL</p>	
<p>SZAFA Z FRONTEM HPL FRONT:</p> 	<p>72 - ZIELONY POŁYSK 82 - CZERWONY POŁYSK 73 - BIAŁY POŁYSK 74 - POMARAŃCZOWY POŁYSK</p>	
<p>SZAFA Z FRONTEM HPL</p> 	<p>FRONT - HPL: 101 - CZARNY POŁYSK</p> <p>WIENIEC GÓRNY I KORPUS: 08 - CZARNY</p>	
<p>KOMODA ZE SZKŁEM</p> 	<p>FRONT: 117 - SZKŁO BIAŁE</p> <p>WIENIEC GÓRNY I KORPUS: 67 - BIAŁY PASTEL</p>	<p>FRONT: 116 - SZKŁO CZARNE</p> <p>WIENIEC GÓRNY I KORPUS: 08 - CZARNY</p>
<p>FRONT SZKŁO</p> 	<p>50 – SZKŁO BEZBARWNE</p>	
<p>WIENIEC GÓRNY I KORPUS</p> 	<p>67 – BIAŁY PASTEL 08 – CZARNY</p>	

WIDOK I RZUT OBIEKTU	WYMIARY (mm)			SYMBOL	UWAGI
	Szerokość a / a'	Głębokość b / b'	Wysokość h		

**BIURKA Z BLATEM SZKLANYM**

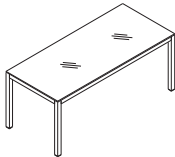
	1600	800	760	<b>IM04S</b>	
	1800	900	760	<b>IM05S</b>	
	2000	900	760	<b>IM06S</b>	

**OSŁONY PŁYTOWE DO BIUREK**

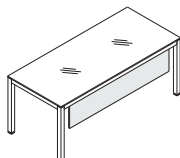
	1400	18	350	<b>IM04B</b>	
	1600	18	350	<b>IM05B</b>	
	1800	18	350	<b>IM06B</b>	

**PRZYSTAWKA DO BIURKA Z BLATEM SZKLANYM**

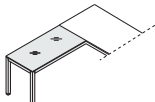
	1200	600	760	<b>IM07S</b>	
---	------	-----	-----	--------------	--

**KONTENER MOBILNY Z WIĘNCEM GÓRNYM I FRONTEM HPL**

	470	616	580	<b>SLK13HT</b>	- płyta melaminowana Front i wieńiec górny HPL
---	-----	-----	-----	----------------	---

**KOMODA ZE SZKŁEM**

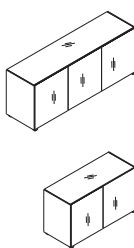
	2000	432	740	<b>IM20S</b>	- wieńiec górny i drzwi szkło
	1334	432	740	<b>IM21S</b>	- wieńiec górny i drzwi szkło

**STOLIK Z BLATEM SZKLANYM**

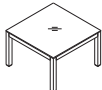



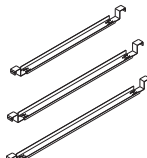





	800	800	500	<b>IM57S</b>	
---	-----	-----	-----	--------------	--

**KANAŁY KABLOWE**







	1496	85	94	<b>EK1200</b>	- do biurka 1600mm
	1696	85	94	<b>EK1400</b>	- do biurka 1800mm
	1896	85	94	<b>EK1600</b>	- do biurka 2000mm

WIDOK I RZUT OBIEKTU	WYMIARY (mm)			SYMBOL
	Szerokość a / a'	Głębokość b / b'	Wysokość h	

**SZAFY Z FRONTEM HPL**

 	802	432	1833	<b>A5104H</b>
 	802	432	1833	<b>A5404H</b>
 	802	432	1129	<b>A3104H</b>
 	802	432	1129	<b>A3404H</b>
 	802	432	777	<b>A2104H</b>

**WITRYNY**

- drzwi szklane w ramce aluminiowej  	802	432	1833	<b>A5104W</b>
- drzwi szklane w ramce aluminiowej - drzwi płytowe: system „Push-to-open” z frontem HPL  	802	432	1833	<b>A5404W</b>
- drzwi szklane w ramce aluminiowej  	802	432	1129	<b>A3104W</b>



Szafy nie posiadają zamka.

WIDOK I RZUT OBIEKTU	WYMIARY (mm)			SYMBOL	UWAGI
	Szerokość a / a'	Głębokość b / b'	Wysokość h		

## STÓŁ MODUŁOWY

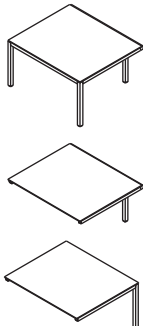
	1200	1400	760	<b>IM53</b>	- element początkowy
	1200	1400	760	<b>IM54</b>	- element środkowy
	1200	1400	760	<b>IM55</b>	- element końcowy

## PRZYKŁADY ARANŻACJI

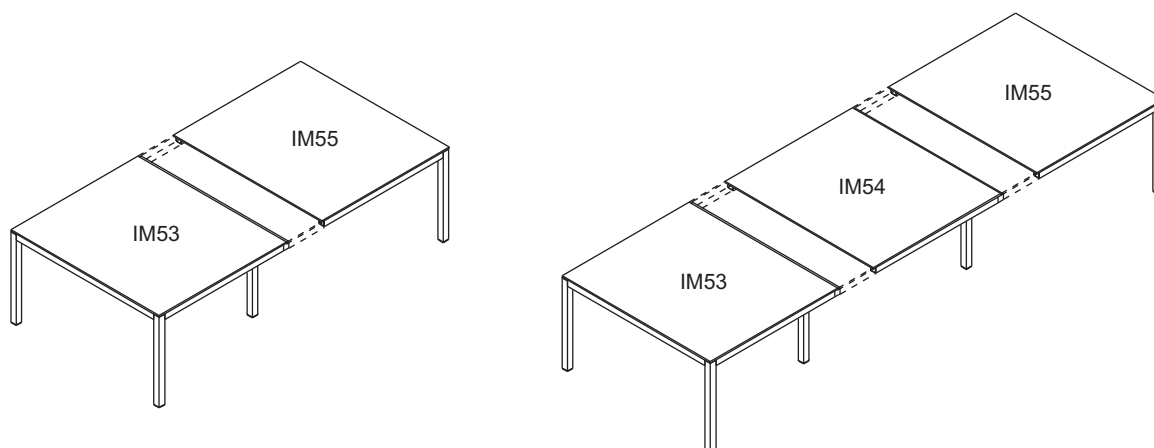

## ELEMENTY DODATKOWE

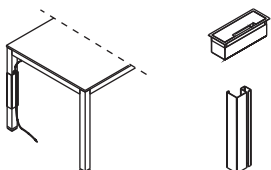
	300	110	110	<b>M01</b>	- 4 x 230V - 2 x RJ45 104-szary struktura - wyłącznie do blatów płytowych
	-	-	350	<b>IM10</b>	- pionowy organizator kablowy, pleksiglas bezbarwny

## KONFIGURACJA MEDIABOX M01: STOŁY MODUŁOWE



- możliwość usytuowania w jednym miejscu (M)
- opcję należy dopisać na końcu symbolu oraz doliczyć wartość mediabox M01 do ceny biurka:  
np. **IM53M**

**OPIS TECHNICZNY**

**Zastosowane materiały:**

- płyta melaminowana
- profil aluminiowy anodowany, malowany proszkowo, z detalami chromowanymi

**BIURKO, PRZYSTAWKA, STOLIKI, STÓŁ**

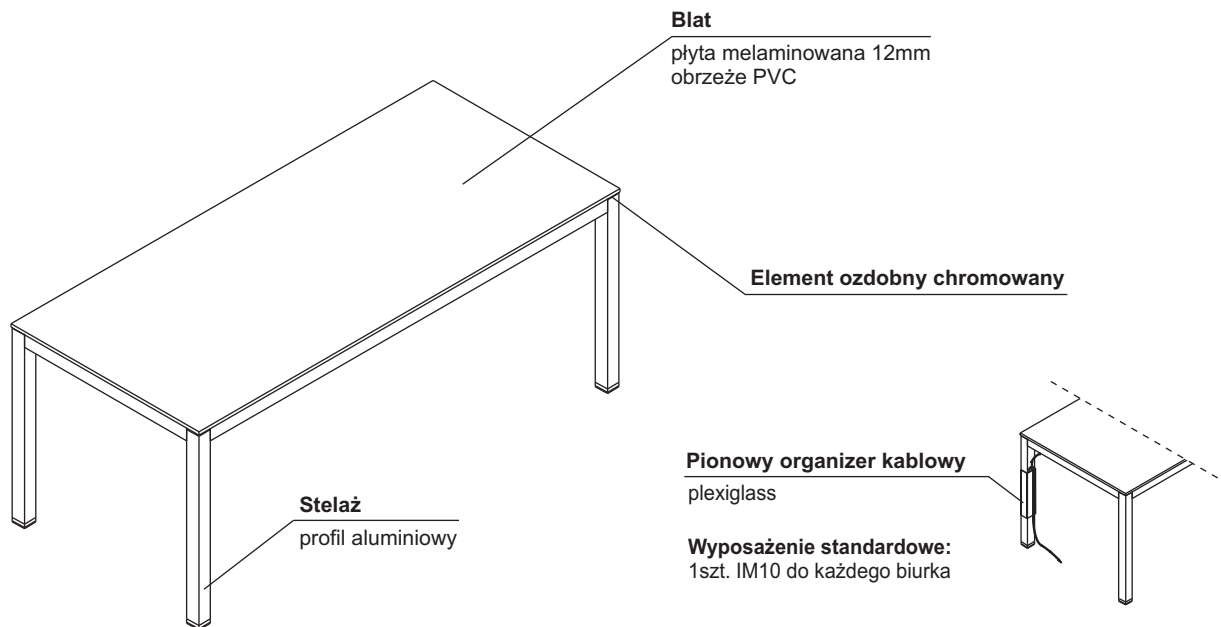

**BLENDY, PRZYSTAWKA**

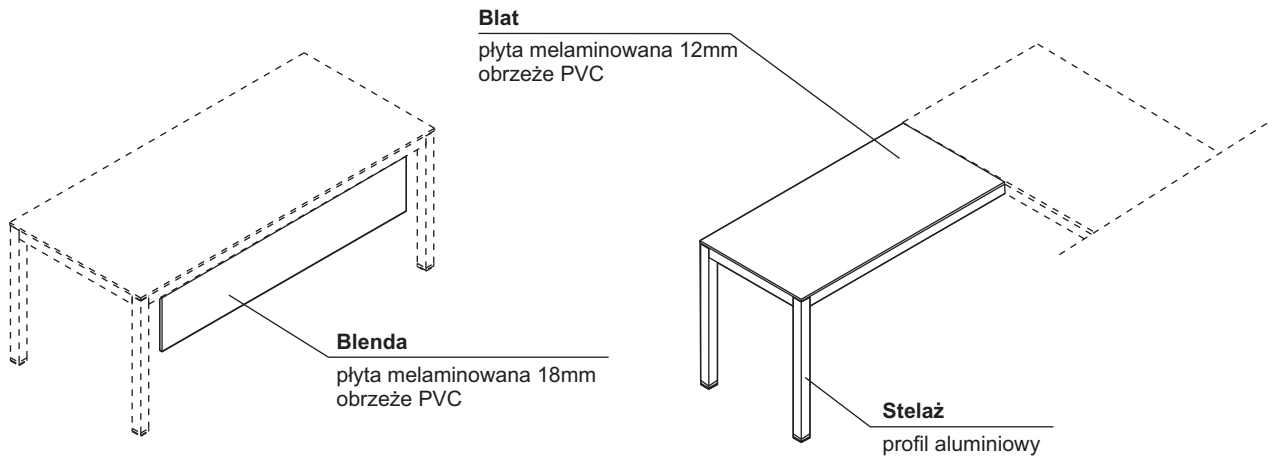

**STÓŁ KONFERENCYJNY**

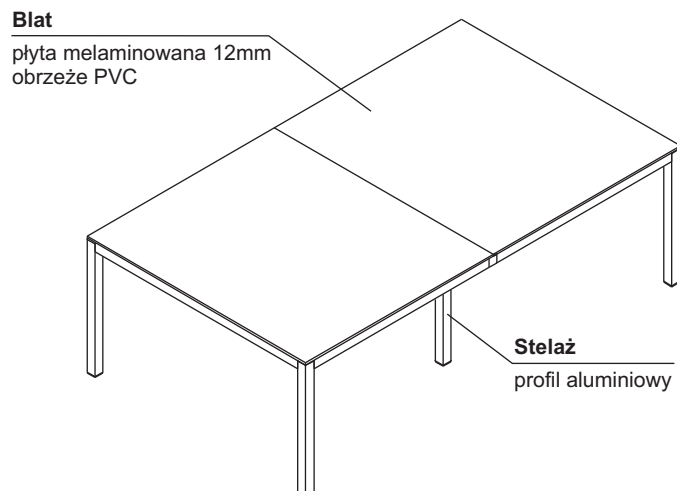



## OPIS TECHNICZNY SZAFY

### Wieniec górny

plyta melaminowana 28mm  
obrzeże PVC

### Boki

plyta melaminowana 18mm  
obrzeże PVC

### Stopki

regulacja od wewnątrz

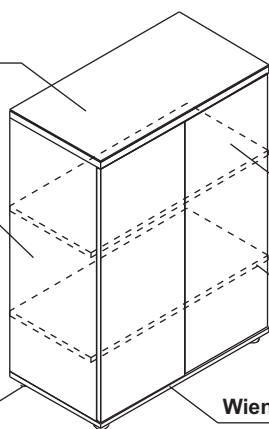

### Front: System „Push-to-open”

laminat HPL

### Półka

plyta melaminowana  
18mm obrzeże PVC

### Wieniec dolny

plyta melaminowana 18mm  
obrzeże PVC

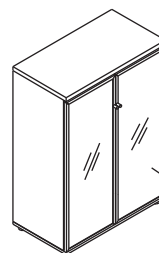

### Front, ramka aluminiowa

szkło hartowane, bezbarwne  
w ramce aluminiowej

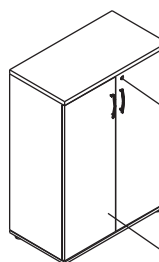

### Zamek patentowy

### Front

plyta melaminowana  
18mm, obrzeże PVC

## KOMODA, SZAFKA ZS02, ZS03

### Wieniec górny

plyta melaminowana 12mm,  
obrzeże PVC

### Boki

plyta melaminowana  
18mm, obrzeże PVC

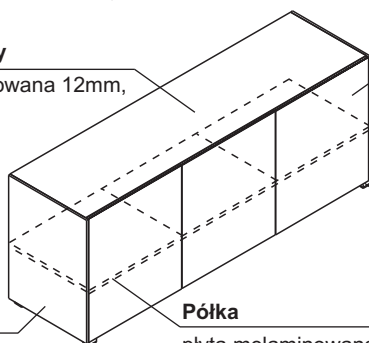

### Półka

plyta melaminowana  
18mm, obrzeże PVC

### Front System „Push-to-open”

plyta melaminowana 18mm  
obrzeże PVC

### Stopki

regulacja od  
wewnątrz

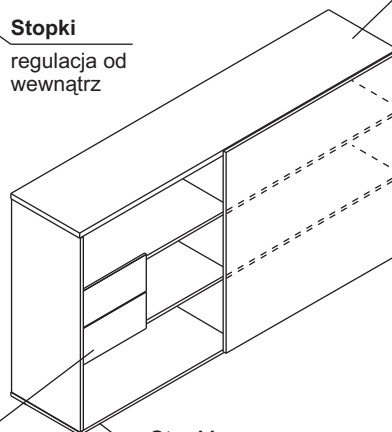

### Szuflada

plyta melaminowana  
12mm, obrzeże PVC

### Stopki

regulacja od wewnątrz

### Wieniec górny

plyta melaminowana 28mm  
obrzeże PVC

### Front

drzwi przesuwne zamocowane  
na metalowym mechanizmie  
z samodomykiem

### ZS02

plyta melaminowana 18mm  
pokryta laminatem HPL  
obrzeże PCV

### ZS03

plyta melaminowana 18 mm  
obrzeże PVC

## KONTENER SLK13HT

### Korpus

plyta melaminowana  
18mm, obrzeże PVC

### Szuflady metalowe

z systemem cichego domytku  
„silent system”,  
prowadnice kulkowe,  
nośność 35 kg

### Kółka

ø 50mm, dwa z hamulcem

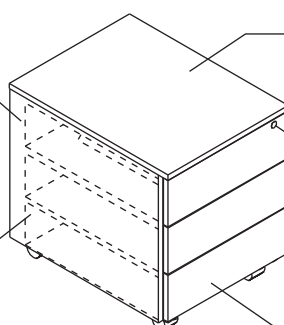

### Wieniec górny

HPL

### Zamek centralny

blokada wysuwu szuflady  
łamany klucz

### Front

HPL

## KOLORYSTYKA

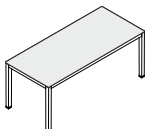
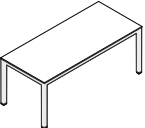
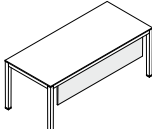
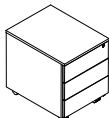
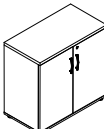
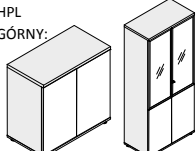
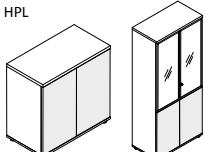
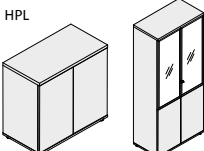
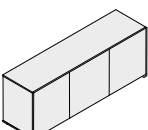
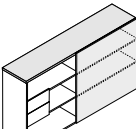
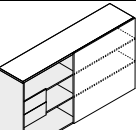
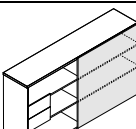
<p>BLAT, PRZYSTAWKA, STOLIK</p>		<p>31 – DĄB KANADYJSKI 34 – KASZTAN 67 – BIAŁY PASTEL</p>
<p>STELAŻ</p>		<p>15 – METAL BIAŁY POŁYSK 08 – METAL CZARNY</p>
<p>OSŁONA</p>		<p>67 – BIAŁY PASTEL 08 – CZARNY</p>
<p>KONTENER HPL SLK13HT</p>		<p>FRONT I WIENIEC GÓRNY HPL:      FRONT I WIENIEC GÓRNY I HPL: 73 - BIAŁY POŁYSK                      101 - CZARNY POŁYSK KORPUS:                                      KORPUS: 67 - BIAŁY PASTEL                        08 - CZARNY</p>
<p>FRONT, WIENIEC GÓRNY I KORPUS</p>		<p>31 – DĄB KANADYJSKI 34 – KASZTAN 67 – BIAŁY PASTEL</p>
<p>SZAFA Z FRONTEM HPL KORPUS I WIENIEC GÓRNY:</p>		<p>67 – BIAŁY PASTEL</p>
<p>SZAFA Z FRONTEM HPL FRONT:</p>		<p>72 - ZIELONY POŁYSK 73 - BIAŁY POŁYSK 74 - POMARAŃCZOWY POŁYSK 82 - CZERWONY POŁYSK</p>
<p>SZAFA Z FRONTEM HPL</p>		<p>FRONT - HPL: 101 - CZARNY POŁYSK WIENIEC GÓRNY I KORPUS: 08 - CZARNY</p>
<p>KOMODA IM20</p>		<p>31 – DĄB KANADYJSKI 34 – KASZTAN</p>
<p>WIENIEC GÓRNY I FRONT – Z503</p>		<p>31 – DĄB KANADYJSKI 34 – KASZTAN 67 – BIAŁY PASTEL</p>
<p>KORPUS – Z503</p>		<p>67 – BIAŁY PASTEL</p>
<p>FRONT HPL – Z502</p>		<p>72 - ZIELONY POŁYSK 73 - BIAŁY POŁYSK 74 - POMARAŃCZOWY POŁYSK 82 - CZERWONY POŁYSK</p>

## KOLORYSTYKA

WIENIEC GÓRNY  
I KORPUS – ZS02

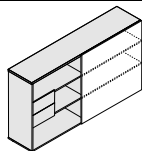

67 – BIAŁY PASTEL

FRONT SZKŁO

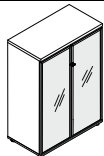

50 – SZKŁO BEZBARWNE

KORPUS

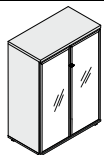

67 – BIAŁY PASTEL

08 – CZARNY

WIDOK I RZUT OBIEKTU	WYMIARY (mm)			SYMBOL	UWAGI
	Szerokość a / a'	Głębokość b / b'	Wysokość h		

**BIURKA Z BLATEM PŁYTOWYM**

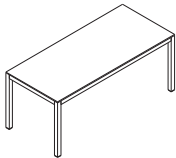
	1600	800	760	<b>IM04</b>	
	1800	900	760	<b>IM05</b>	
	2000	900	760	<b>IM06</b>	

**OŚLONY PŁYTOWE DO BIUREK**

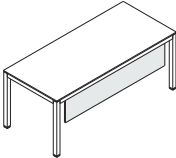
	1400	18	350	<b>IM04B</b>	
	1600	18	350	<b>IM05B</b>	
	1800	18	350	<b>IM06B</b>	

**PRZYSTAWKA DO BIURKA Z BLATEM PŁYTOWYM**

	1200	600	760	<b>IM07</b>	
---	------	-----	-----	-------------	--

**KONTENER MOBILNY Z WIĘNCEM GÓRNYM I FRONTEM HPL**

	470	616	580	<b>SLK13HT</b>	- płyta melaminowana Front i wieńiec górny HPL
---	-----	-----	-----	----------------	---

**STOLIK**

- talerz: $\varnothing$ 620mm - kolumna: $\varnothing$ 100mm 	$\varnothing$ 1200	-	730	<b>ST12</b>	- talerz - stal nierdzewna - kolumna - malowana proszkowo, 15-biały, 115-czarny, 09-aluminium
--	--------------------	---	-----	-------------	--

**STOLIK Z BLATEM PŁYTOWYM**

	800	800	500	<b>IM57</b>	
---	-----	-----	-----	-------------	--

**KANAŁY KABLOWE**

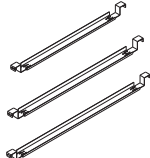





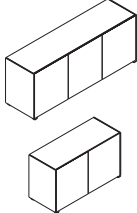

	1496	85	94	<b>EK1200</b>	- do biurka 1600mm
	1696	85	94	<b>EK1400</b>	- do biurka 1800mm
	1896	85	94	<b>EK1600</b>	- do biurka 2000mm

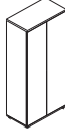
WIDOK I RZUT OBIEKTU	WYMIARY (mm)			SYMBOL
	Szerokość a / a'	Głębokość b / b'	Wysokość h	





**KOMODA**

	2000	432	740	<b>IM20</b>
	1334	432	740	<b>IM21</b>

**SZAFY Z FRONTEM HPL**

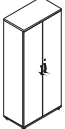
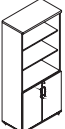
 	802	432	1833	<b>A5104H</b>
 	802	432	1833	<b>A5404H</b>
 	802	432	1129	<b>A3104H</b>
 	802	432	1129	<b>A3404H</b>
 	802	432	777	<b>A2104H</b>

**SZAFY Z UCHWYTEM**





	802	432	1833	<b>A5104</b>
	802	432	1833	<b>A5404</b>
	802	432	1129	<b>A3104</b>
	802	432	1129	<b>A3504</b>
	802	432	777	<b>A2104</b>



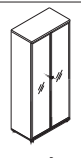

Szafy nie posiadają zamka.

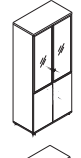
WIDOK I RZUT OBIEKTU	WYMIARY (mm)			SYMBOL
	Szerokość a / a'	Głębokość b / b'	Wysokość h	

**WITRYNY**

- drzwi szklane w ramce aluminiowej  	802	432	1833	<b>A5104W</b>
- drzwi szklane w ramce aluminiowej - drzwi płytowe: system „Push-to-open” z frontem HPL  	802	432	1833	<b>A5404W</b>
- drzwi szklane w ramce aluminiowej  	802	432	1129	<b>A3104W</b>

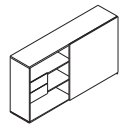
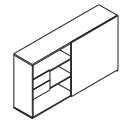
**SZAFY Z DRZWIAMI PRZESUWNymi**

- front HPL 	2000	434	1129	<b>ZS02</b>
- front melamina 	2000	432	1129	<b>ZS03</b>
- szuflada do szaf 	428	385	403	<b>ZSZ01</b>



Szafy nie posiadają zamka.

WIDOK I RZUT OBIEKTU	WYMIARY (mm)			SYMBOL	UWAGI
	Szerokość a / a'	Głębokość b / b'	Wysokość h		

## STÓŁ MODUŁOWY

	1200	1400	760	<b>IM53</b>	- element początkowy
	1200	1400	760	<b>IM54</b>	- element środkowy
	1200	1400	760	<b>IM55</b>	- element końcowy

## PRZYKŁADY ARANŻACJI

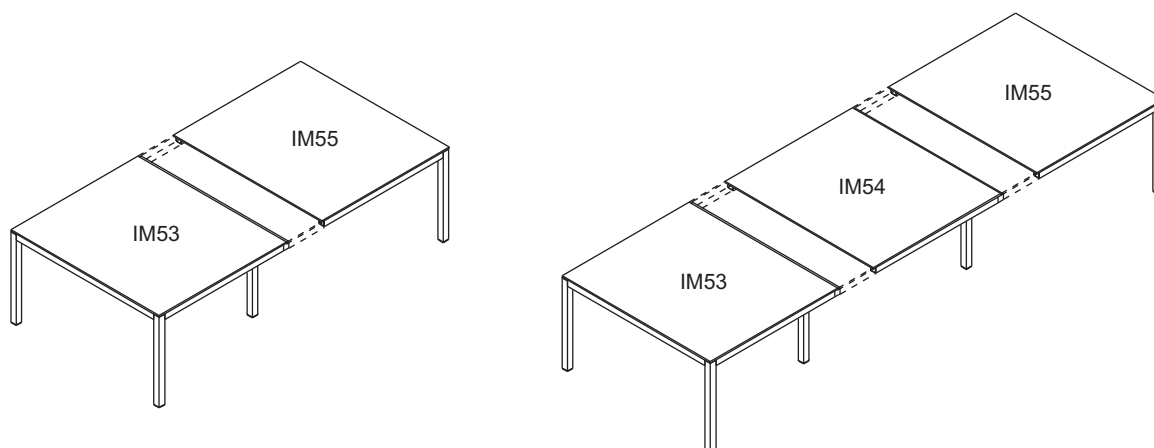

## ELEMENTY DODATKOWE

	300	110	110	<b>M01</b>	- 4 x 230V - 2 x RJ45 104-szary struktura - wyłącznie do blatów płytowych
	-	-	350	<b>IM10</b>	- pionowy organizer kablowy, pleksiglas bezbarwny

## KONFIGURACJA MEDIABOX M01: BIURKA Z BLATEM PŁYTOWYM



- możliwość usytuowania w jednym miejscu (M)
- opcję należy dopisać na końcu symbolu oraz doliczyć wartość mediabox M01 do ceny biurka:  
np.

IM06M

## KONFIGURACJA MEDIABOX M01: STOŁY MODUŁOWE



- możliwość usytuowania w jednym miejscu (M)
- opcję należy dopisać na końcu symbolu oraz doliczyć wartość mediabox M01 do ceny biurka:  
np.

IM53M