



OPIS TECHNICZNY

Blat górny

plyta melaminowana + szkło LACOBEL
28+4mm (32mm)

Listwy ozdobne

PVC
Kolor: 09-aluminium

Blat roboczy

plyta melaminowana
28mm

Panel boczny

plyta melaminowana
28mm

Front

materiał:
HPL MAT

Półka

Półka montowana do frontu lady
na wysokości blatu roboczego

Półka

HPL 6mm

Przelot kablowy

ø 80mm

**Bok łączący lady
niskie i wysokie**

plyta melaminowana
28mm

Panel boczny

plyta melaminowana
28mm

Panel boczny

plyta melaminowana
28mm

Blat górny

plyta melaminowana + szkło LACOBEL
28+4mm (32mm)

Noga podpierająca

plyta melaminowana
28mm

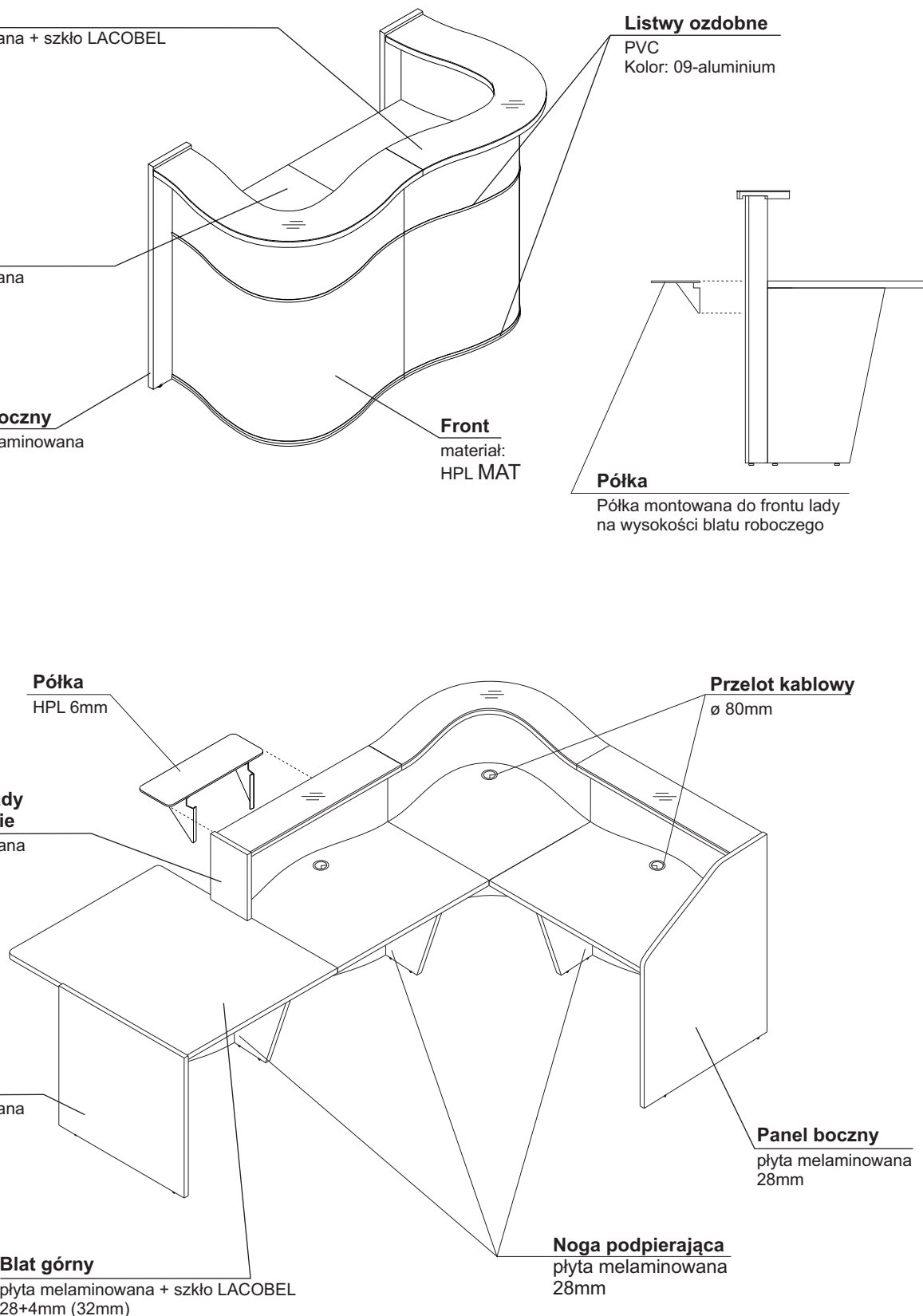

KOLORYSTYKA

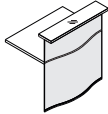
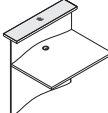
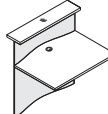
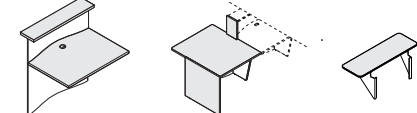
FRONT		<p>67 - BIAŁY PASTEL</p> <p>130 - ZIELONY HPL MAT</p> <p>131 - POMARAŃCZOWY HPL MAT</p> <p>132 - NIEBIESKI HPL MAT</p>
BLAT GÓRNY		SZKŁO LACOBEL, BIAŁY
WNĘTRZE		67 - BIAŁY PASTEL
BLAT GÓRNY, BLAT ROBOCZY, NOGI PŁYTOWE		67 - BIAŁY PASTEL

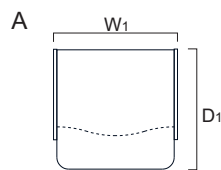
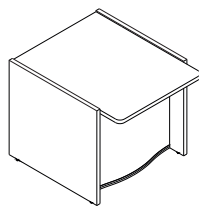

A: LUV10: LUV06L + LUV01 + LUV06P

SYMBOL	WYMIARY (mm)								UWAGI
	W ₁	W ₂	D ₁	D ₂	H	kg	m ³	pcs	
LUV10	1026	-	1119	-	755	55	0,198	4	

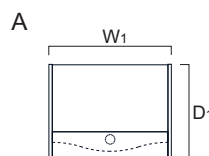
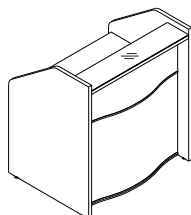

A: LUV11: LUV05L + LUV02 + LUV05P
A: LUV12: LUV05L + LUV03 + LUV05P

SYMBOL	WYMIARY (mm)								UWAGI
	W ₁	W ₂	D ₁	D ₂	H	kg	m ³	pcs	
LUV11	806	-	770	-	1103	64	0,188	4	
LUV12	1026	-	770	-	1103	69	0,225	4	

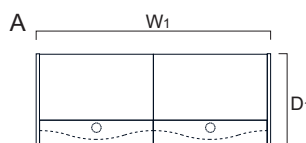
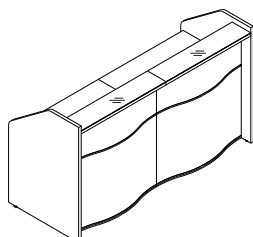

A: LUV13: LUV05L + 2xLUV02 + LUV05P
A: LUV14: LUV05L + 2xLUV03 + LUV05P

SYMBOL	WYMIARY (mm)								UWAGI
	W ₁	W ₂	D ₁	D ₂	H	kg	m ³	pcs	
LUV13	1556	-	770	-	1103	98	0,316	6	
LUV14	1996	-	770	-	1103	108	0,39	6	

LEGENDA:

- WAGA NETTO

- OBJĘTOŚĆ

- ILOŚĆ PACZEK

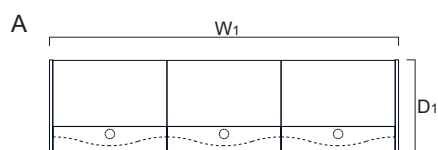
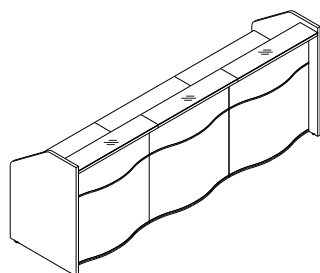

A: LUV15: LUV05L + 3xLUV02 + LUV05P
 A: LUV16: LUV05L + 3xLUV03 + LUV05P

SYMBOL	WYMIARY (mm)					kg	m ³	pcs	UWAGI
	W ₁	W ₂	D ₁	D ₂	H				
LUV15	2306	-	770	-	1103	132	0,444	8	
LUV16	2966	-	770	-	1103	147	0,555	8	

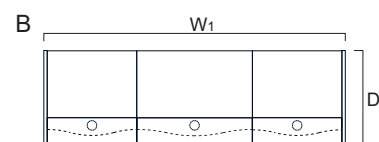
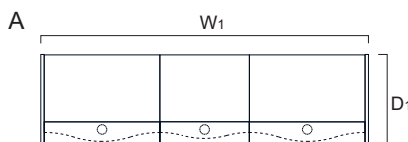
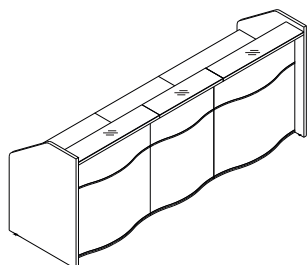

A: LUV17: LUV05L + LUV02 + 2xLUV03 + LUV05P
 B: LUV18: LUV05L + LUV03 + 2xLUV02 + LUV05P

SYMBOL	WYMIARY (mm)					kg	m ³	pcs	UWAGI
	W ₁	W ₂	D ₁	D ₂	H				
LUV17	2746	-	770	-	1103	142	0,518	8	
LUV18	2526	-	770	-	1103	137	0,481	8	

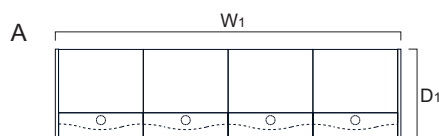
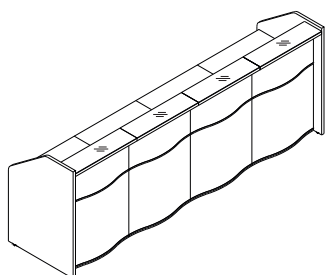

A: LUV19: LUV05L + 4xLUV02 + LUV05P
 A: LUV20: LUV05L + 4xLUV03 + LUV05P

SYMBOL	WYMIARY (mm)					kg	m ³	pcs	UWAGI
	W ₁	W ₂	D ₁	D ₂	H				
LUV19	3496	-	770	-	1103	166	0,572	10	
LUV20	3936	-	770	-	1103	186	0,72	10	

LEGENDA:



- WAGA NETTO

- OBJĘTOŚĆ

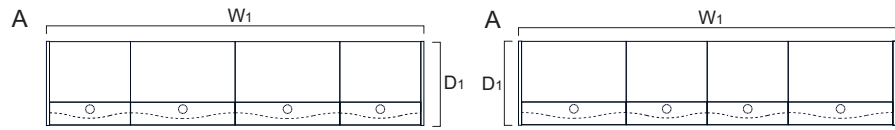
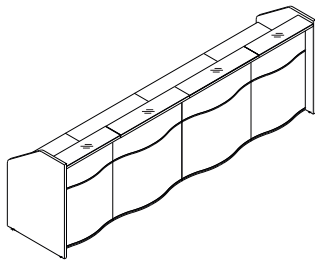
- ILOŚĆ PACZEK



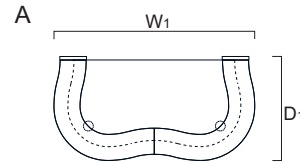
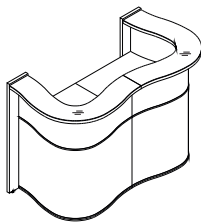

A: LUV21: LUV05L + 2xLUV02 + 2xLUV03 + LUV05P

SYMBOL	WYMIARY (mm)								UWAGI
	W ₁	W ₂	D ₁	D ₂	H	kg	m ³	pcs	
LUV21	3496	-	770	-	1103	176	0,646	10	



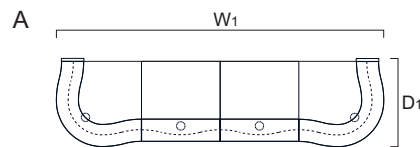
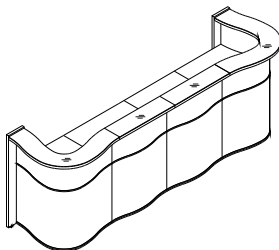

A: LUV22: LUV08L + 2xLUV04 + LUV08P

SYMBOL	WYMIARY (mm)								UWAGI
	W ₁	W ₂	D ₁	D ₂	H	kg	m ³	pcs	
LUV22	1624	-	841	-	1103	92	0,512	6	



A: LUV23: LUV08L + 2xLUV04 + 2xLUV02 + LUV08P

A: LUV24: LUV08L + 2xLUV04 + 2xLUV03 + LUV08P

SYMBOL	WYMIARY (mm)								UWAGI
	W ₁	W ₂	D ₁	D ₂	H	kg	m ³	pcs	
LUV23	3124	-	841	-	1103	160	0,768	10	
LUV24	3564	-	841	-	1103	170	0,842	10	

LEGENDA:

 - WAGA NETTO  - OBJĘTOŚĆ  - ILOŚĆ PACZEK

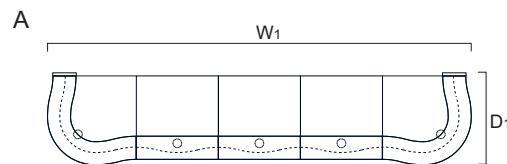
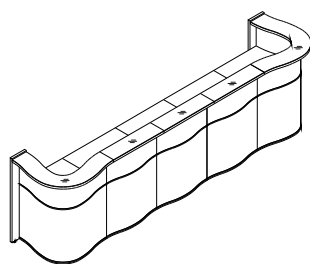

A: LUV25: LUV08L + 2xLUV04 + 3xLUV02 + LUV08P
 A: LUV26: LUV08L + 2xLUV04 + 3xLUV03 + LUV08P

SYMBOL	WYMIARY (mm)								UWAGI
	W ₁	W ₂	D ₁	D ₂	H	kg	m ³	pcs	
LUV25	3874	-	841	-	1103	194	0,896	12	
LUV26	4534	-	841	-	1103	209	1,007	12	

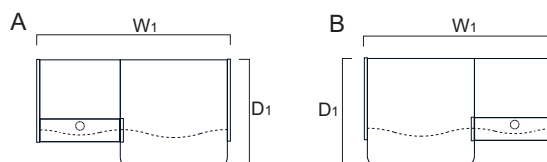
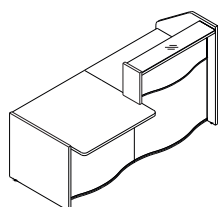

A: LUV27L: LUV05L + LUV02 + LUV07P + LUV01 + LUV06P
 B: LUV27P: LUV06L + LUV01 + LUV07L + LUV02 + LUV05P
 A: LUV28L: LUV05L + LUV03 + LUV07P + LUV01 + LUV06P
 B: LUV28P: LUV06L + LUV01 + LUV07L + LUV03 + LUV05P

SYMBOL		WYMIARY (mm)								UWAGI
A	B	W ₁	W ₂	D ₁	D ₂	H	kg	m ³	pcs	
LUV27L	LUV27P	1776	-	1019	-	1103	95	0,334	7	
LUV28L	LUV28P	1996	-	1019	-	1103	100	0,371	7	

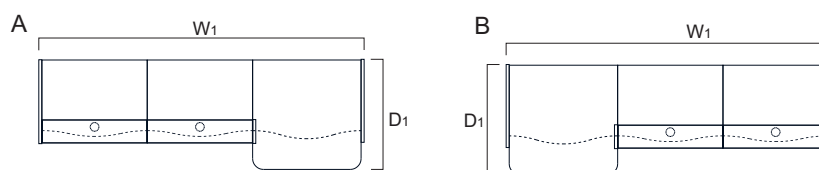
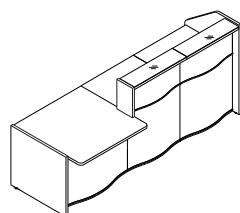

A: LUV29L: LUV05L + 2xLUV02 + LUV07P + LUV01 + LUV06P
 B: LUV29P: LUV06L + LUV01 + LUV07L + 2xLUV02 + LUV05P
 A: LUV30L: LUV05L + 2xLUV03 + LUV07P + LUV01 + LUV06P
 B: LUV30P: LUV06L + LUV01 + LUV07L + 2xLUV03 + LUV05P

SYMBOL		WYMIARY (mm)								UWAGI
A	B	W ₁	W ₂	D ₁	D ₂	H	kg	m ³	pcs	
LUV29L	LUV29P	2526	-	1019	-	1103	129	0,462	9	
LUV30L	LUV30P	2966	-	1019	-	1103	139	0,536	9	

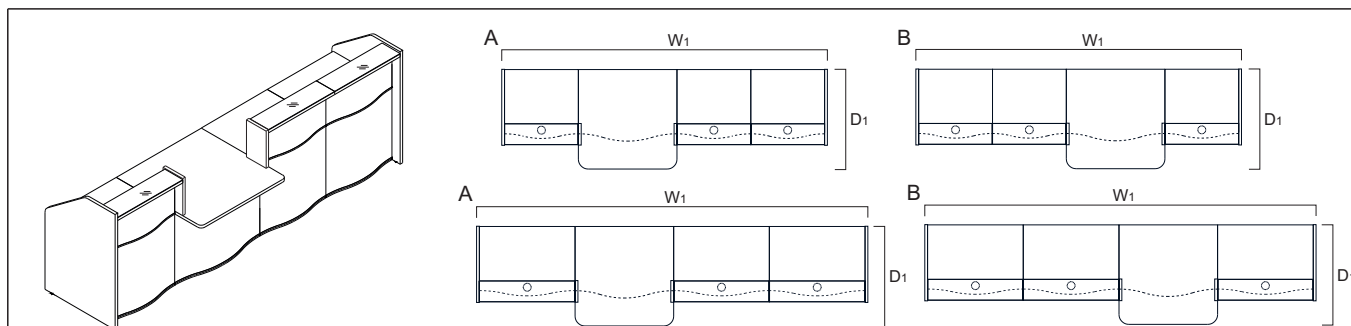

LEGENDA:

- WAGA NETTO - OBJĘTOŚĆ - IŁOŚĆ PACZEK



A,B: LUV31: LUV05L + 2xLUV02 + LUV07P + LUV01 + LUV07L + LUV02 + LUV05P

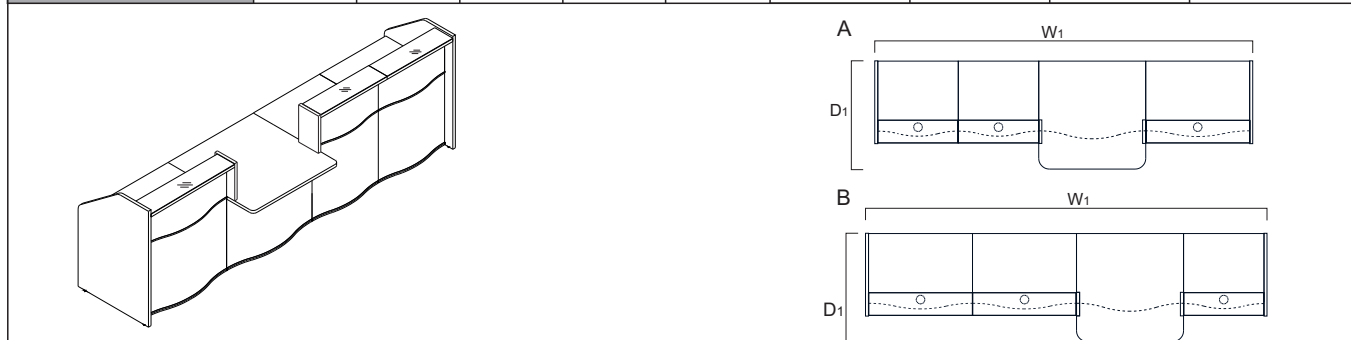

A,B: LUV32: LUV05L + 2xLUV03 + LUV07P + LUV01 + LUV07L + LUV03 + LUV05P

SYMBOL	WYMIARY (mm)								UWAGI
	W ₁	W ₂	D ₁	D ₂	H	kg	m ³	pcs	
LUV31	3276	-	1019	-	1103	169	0,6	12	
LUV32	3936	-	1019	-	1103	184	0,71	12	



A: LUV33: LUV5L + LUV03 + LUV07P + LUV01 + LUV07L + 2xLUV02 + LUV05P

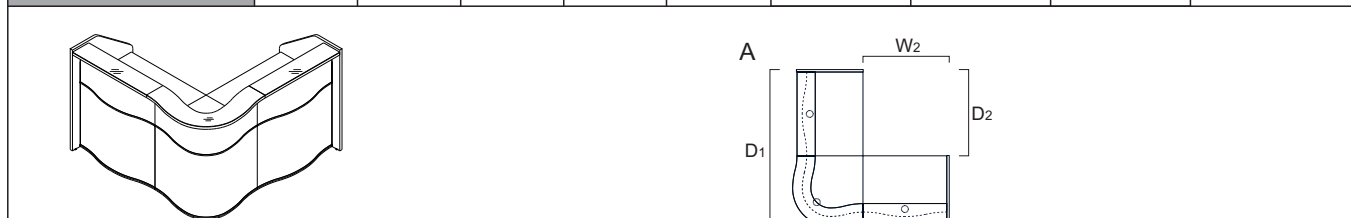

B: LUV34: LUV5L + LUV02 + LUV07P + LUV01 + LUV07L + 2xLUV03 + LUV05P

SYMBOL	WYMIARY (mm)								UWAGI
	W ₁	W ₂	D ₁	D ₂	H	kg	m ³	pcs	
LUV33	2526	-	1019	-	1103	174	0,63	12	
LUV34	2966	-	1019	-	1103	179	0,67	12	



A: LUV35: LUV5L + LUV02 + LUV04 + LUV02 + LUV05P

A: LUV36: LUV5L + LUV03 + LUV04 + LUV03 + LUV05P

SYMBOL	WYMIARY (mm)								UWAGI
	W ₁	W ₂	D ₁	D ₂	H	kg	m ³	pcs	
LUV35	1590	778	1590	778	1103	139	0,562	8	
LUV36	1810	998	1810	998	1103	149	0,636	8	

LEGENDA:

 - WAGA NETTO

 - OBJĘTOŚĆ

 - ILOŚĆ PACZEK

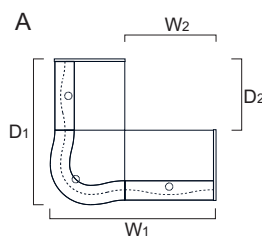
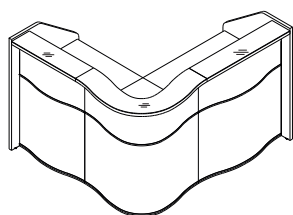

A: LUV37: LUV05L + LUV03 + LUV04 + LUV02 + LUV05P

SYMBOL	WYMIARY (mm)								UWAGI
	W ₁	W ₂	D ₁	D ₂	H	kg	m ³	pcs	
LUV37	1810	998	1590	778	1103	144	0,599	8	

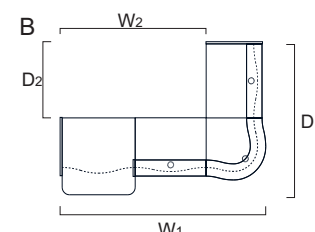
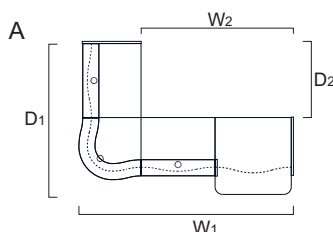
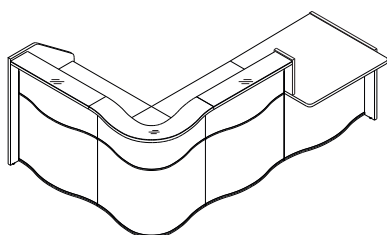

A: LUV38L: LUV06L + LUV01 + LUV07L + LUV02 + LUV04 + LUV02 + LUV05P
 B: LUV38P: LUV05L + LUV02 + LUV04 + LUV02 + LUV07P + LUV01 + LUV06P
 A: LUV39L: LUV06L + LUV01 + LUV07L + LUV03 + LUV04 + LUV03 + LUV05P
 B: LUV39P: LUV05L + LUV03 + LUV04 + LUV03 + LUV07P + LUV01 + LUV06P

SYMBOL		WYMIARY (mm)								UWAGI
A	B	W ₁	W ₂	D ₁	D ₂	H	kg	m ³	pcs	
LUV38L	LUV38P	2560	1748	1590	778	1103	170	0,708	11	
LUV39L	LUV39P	2780	1968	1054	998	1103	180	0,782	11	

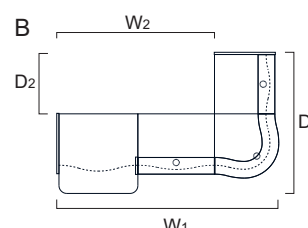
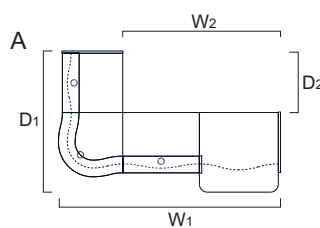
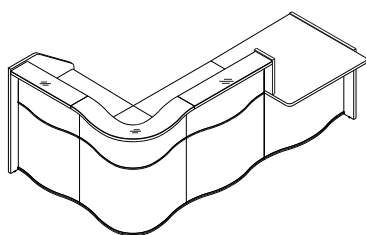

A: LUV40L: LUV06L + LUV01 + LUV07L + LUV03 + LUV04 + LUV02 + LUV05P
 B: LUV40P: LUV05L + LUV02 + LUV04 + LUV03 + LUV07P + LUV01 + LUV06P

SYMBOL		WYMIARY (mm)								UWAGI
A	B	W ₁	W ₂	D ₁	D ₂	H	kg	m ³	pcs	
LUV40L	LUV40P	2780	1968	1792	778	1103	175	0,745	11	

LEGENDA:

- WAGA NETTO

- OBJĘTOŚĆ

- ILOŚĆ PACZEK

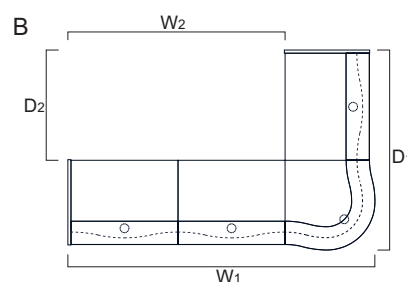
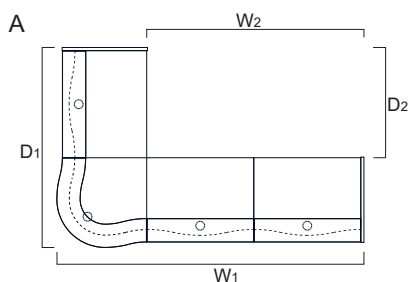
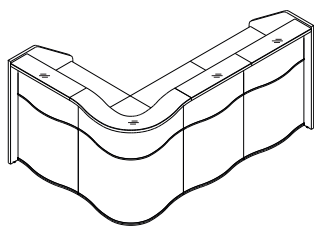

A,B: LUV41: LUV05L + 2xLUV02 + LUV04 + LUV02 + LUV05P
 A,B: LUV42: LUV05L + 2xLUV03 + LUV04 + LUV03 + LUV05P

SYMBOL	WYMIARY (mm)								UWAGI
	W ₁	W ₂	D ₁	D ₂	H	kg	m ³	pcs	
LUV41	2340	1528	1590	778	1103	173	0,69	10	
LUV42	2780	1968	1810	998	1103	188	0,8	10	

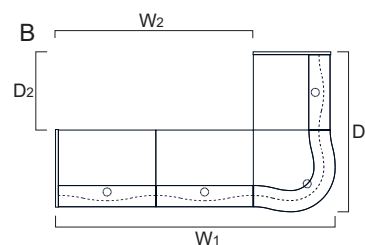
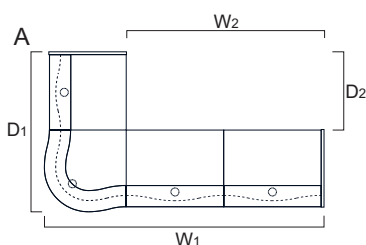
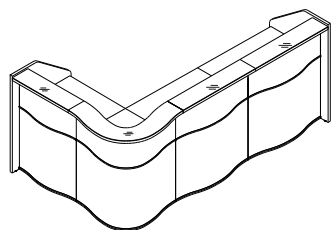

A: LUV43L: LUV05L + 2xLUV03 + LUV04 + LUV02 + LUV05P
 B: LUV43P: LUV05L + LUV02 + LUV04 + 2xLUV03 + LUV05P
 A: LUV44L: LUV05L + 2xLUV02 + LUV04 + LUV03 + LUV05P
 B: LUV44P: LUV05L + LUV03 + LUV04 + 2xLUV02 + LUV05P

SYMBOL		WYMIARY (mm)								UWAGI
A	B	W ₁	W ₂	D ₁	D ₂	H	kg	m ³	pcs	
LUV43L	LUV43P	2780	1968	1792	778	1103	183	0,764	10	
LUV44L	LUV44P	2560	1748	2012	998	1103	178	0,727	10	

LEGENDA:

- WAGA NETTO

- OBJĘTOŚĆ

- ILOŚĆ PACZEK

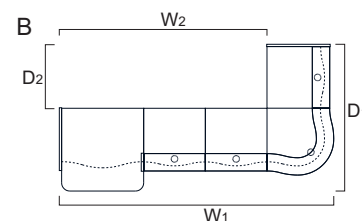
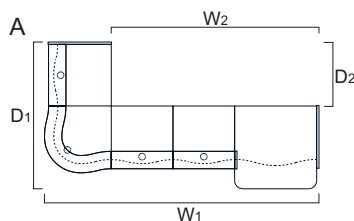
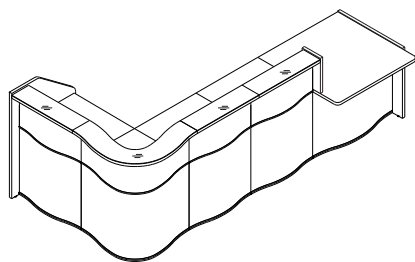

- A: LUV45L: LUV06L + LUV01 + LUV07L + 2xLUV02 + LUV04 + LUV02 + LUV05P
- B: LUV45P: LUV05L + LUV02 + LUV04 + 2xLUV02 + LUV07P + LUV01 + LUV06P
- A: LUV46L: LUV06L + LUV01 + LUV07L + 2xLUV03 + LUV04 + LUV03 + LUV05P
- B: LUV46P: LUV05L + LUV03 + LUV04 + 2xLUV03 + LUV07P + LUV01 + LUV06P

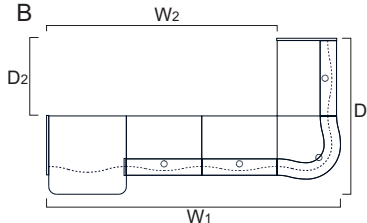
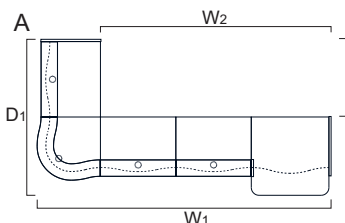

SYMBOL		WYMIARY (mm)								UWAGI
A	B	W ₁	W ₂	D ₁	D ₂	H	kg	m ³	pcs	
LUV45L	LUV45P	3310	2498	1792	778	1103	204	0,836	13	
LUV46L	LUV46P	3750	2938	1810	998	1103	219	0,942	13	

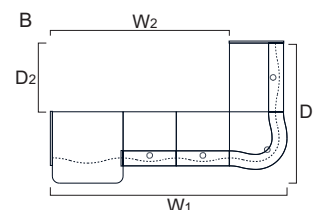
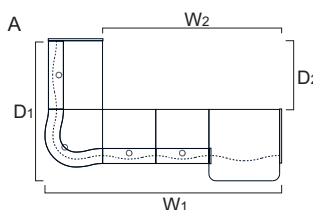
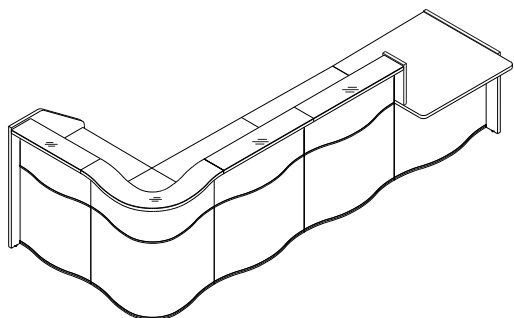

- A: LUV47L: LUV06L + LUV01 + LUV07L + 2xLUV02 + LUV04 + LUV03 + LUV05P
- B: LUV47P: LUV05L + LUV03 + LUV04 + 2xLUV02 + LUV07P + LUV01 + LUV06P
- A: LUV48L: LUV06L + LUV01 + LUV07L + 2xLUV03 + LUV04 + LUV02 + LUV05P
- B: LUV48P: LUV05L + LUV023 + LUV04 + 2xLUV03 + LUV07P + LUV01 + LUV06P

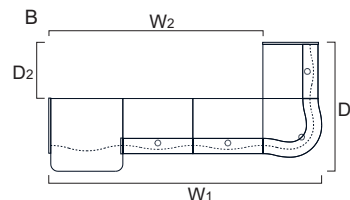
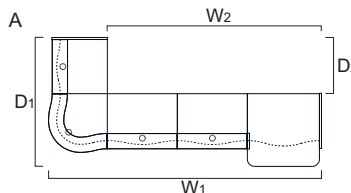

SYMBOL		WYMIARYS (mm)								UWAGI
A	B	W ₁	W ₂	D ₁	D ₂	H	kg	m ³	pcs	
LUV47L	LUV47P	3310	2498	1810	998	1103	214	0,91	13	
LUV48L	LUV48P	3750	2938	1792	778	1103	209	0,873	13	



LEGENDA:

- WAGA NETTO

- OBJĘTOŚĆ

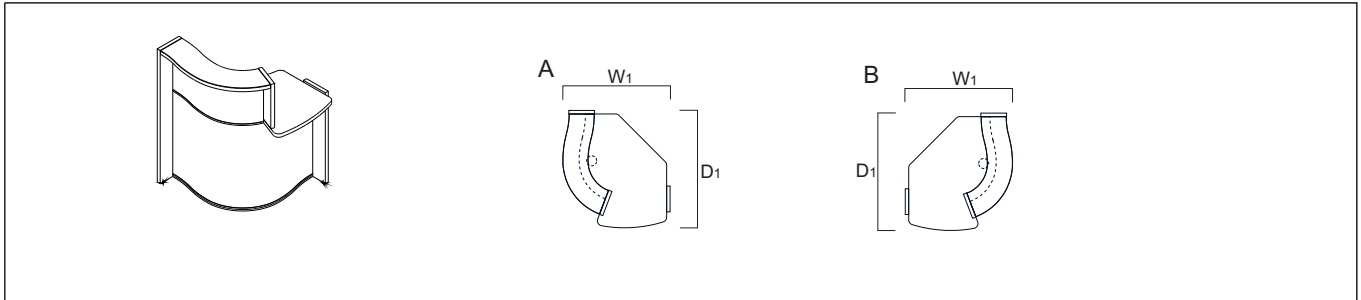
- ILOŚĆ PACZEK





SYMBOL		WYMIARY (mm)								UWAGI
A	B	W ₁	W ₂	D ₁	D ₂	H	kg	m ³	pcs	
LUV49L	LUV49P	858	-	925	-	1103	51	0,294	5	

LEGENDA:









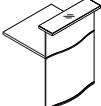
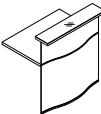

 - WAGA NETTO

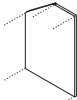
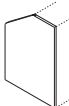
 - OBJĘTOŚĆ

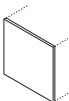
 - ILOŚĆ PACZEK

WIDOK OBIEKTU	WYMIARY (mm)			SYMBOL				UWAGI
	SZEROKOŚĆ	GŁĘBOKOŚĆ	WYSOKOŚĆ		kg	m ³	szt	

ELEMENTY SKŁADOWE

	970	818	740	LUV01	33	0,148	2	
	750	768	1102	LUV02	34	0,128	2	
	970	768	1102	LUV03	39	0,165	2	
	815	815	1102	LUV04	41	0,246	2	
	28	770	1103	LUV05L	15	0,03	1	
	28	770	1103	LUV05P	15	0,03	1	
	28	770	755	LUV06L	11	0,024	1	
	28	770	755	LUV06P	11	0,024	1	
	28	216	363	LUV07L	2	0,004	1	
	28	216	363	LUV07P	2	0,004	1	
	28	216	1103	LUV08L	5	0,01	1	
	28	216	1103	LUV08P	5	0,01	1	
	450	180	180	LUV09	2	0,014	1	

LEGENDA:
 - WAGA NETTO

 - OBJĘTOŚĆ

 - ILOŚĆ PACZEK