

Grupa	III
Kolorystyka	BLAZER

OPIS TECHNICZNY

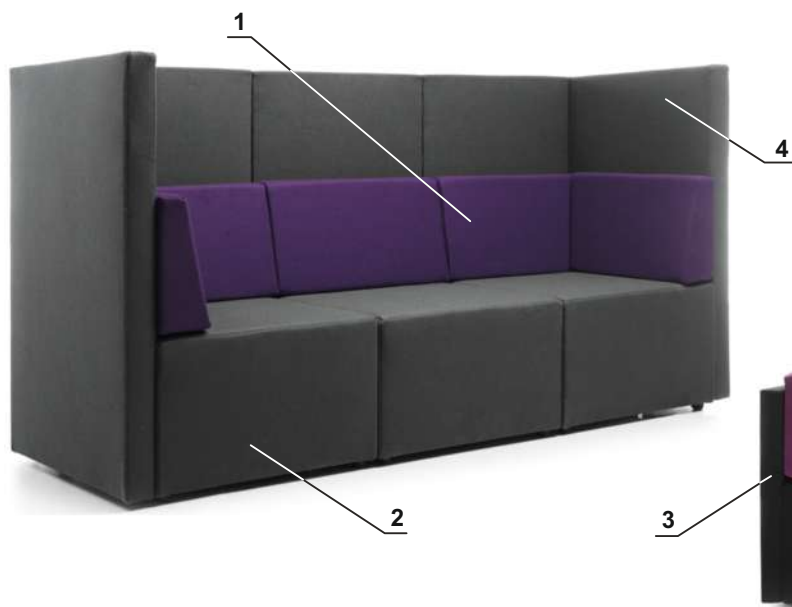

1. Poduszka
2. Pufa
3. Oparcie niskie
4. Oparcie wysokie

WYMIARY

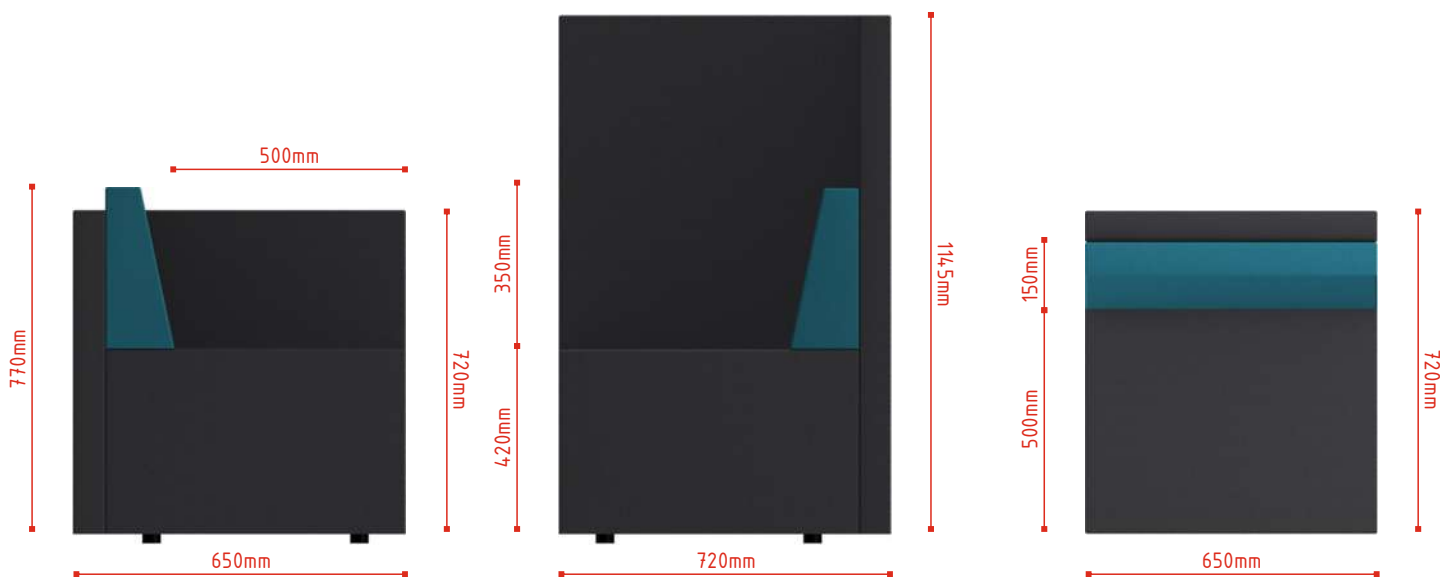

UKŁADY

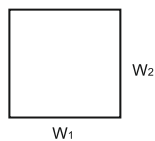
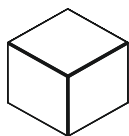

SYMBOL	WYMIARY [mm]										UWAGI
	W ₁	W ₂	D ₁	D ₂	H						
MM-PM	450	450	-	-	420		14.0	0.085	1		

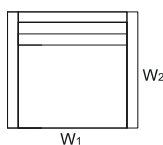
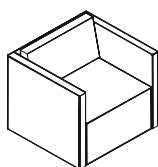

MM-PU + MM-ON + MM-ONP + MM-ONL + MM-PO

SYMBOL	WYMIARY [mm]										UWAGI
	W ₁	W ₂	D ₁	D ₂	H						
MM-1N	790	720	-	-	770		46.4	0.314	5		

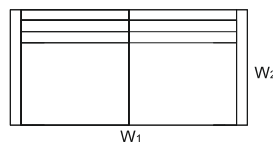
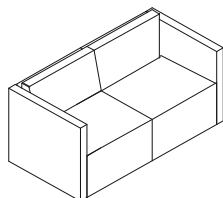

2xMM-PU + 2xMM-ON + 2xMM-PO + MM-ONP + MM-ONL

SYMBOL	WYMIARY [mm]										UWAGI
	W ₁	W ₂	D ₁	D ₂	H						
MM-2N	1440	720	-	-	770		73.4	0.557	8		

LEGENDA:

- WAGA NETTO

- OBJĘTOŚĆ

- ILOŚĆ PACZEK

UKŁADY

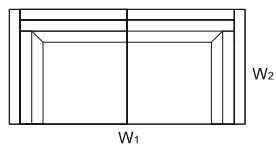
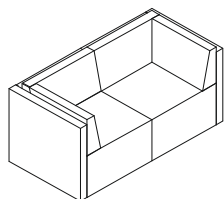

2xMM-PU + 2xMM-ON + 2xMM-PO + MM-ONP + MM-ONL + MM-PP + MM-PL

SYMBOL	WYMIARY					[mm]						UWAGI
	W ₁	W ₂	D ₁	D ₂	H							
MM-2NP	1440	720	-	-	770			77.2	0.618	10		

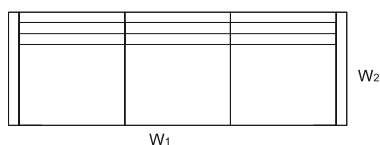
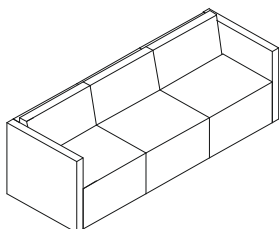

3xMM-PU + 3xMM-ON + 3xMM-PO + MM-ONP + MM-ONL

SYMBOL	WYMIARY					[mm]						UWAGI
	W ₁	W ₂	D ₁	D ₂	H							
MM-3N	2090	720	-	-	770			100.4	0.801	11		

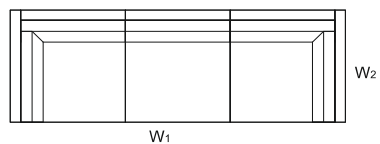
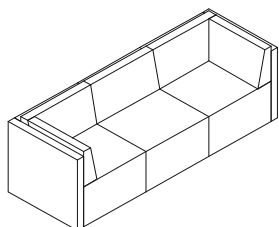

3xMM-PU + 3xMM-ON + 3xMM-PO + MM-ONP + MM-ONL + MM-PP + MM-PL

SYMBOL	WYMIARY					[mm]						UWAGI
	W ₁	W ₂	D ₁	D ₂	H							
MM-3NP	2090	720	-	-	770			104.2	0.861	13		

LEGENDA:

- WAGA NETTO

- OBJĘTOŚĆ

- ILOŚĆ PACZEK

UKŁADY

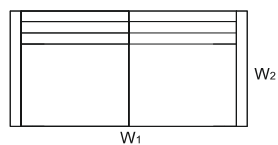
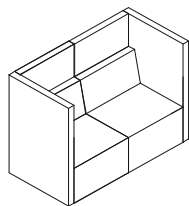

2xMM-PU + 2xMM-OW + 2xMM-PO + MM-OWP + MM-OWL

SYMBOL	WYMIARY					[mm]						UWAGI
	W ₁	W ₂	D ₁	D ₂	H							
MM-2W	1440	720	-	-	1145			kg	m ³	szt		

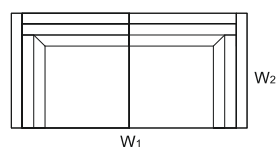
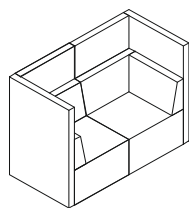

2xMM-PU + 2xMM-OW + 2xMM-PO + MM-OWP + MM-OWL + MM-PP + MM-PL

SYMBOL	WYMIARY					[mm]						UWAGI
	W ₁	W ₂	D ₁	D ₂	H							
MM-2WP	1440	720	-	-	1145			kg	m ³	szt		

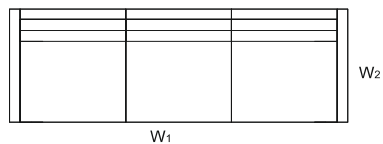
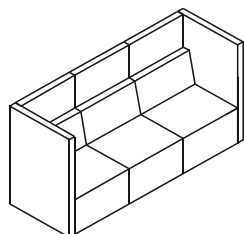

3xMM-PU + 3xMM-OW + 3xMM-PO + MM-OWP + MM-OWL

SYMBOL	WYMIARY					[mm]						UWAGI
	W ₁	W ₂	D ₁	D ₂	H							
MM-3W	2090	720	-	-	1145			kg	m ³	szt		

LEGENDA:

- WAGA NETTO

- OBJĘTOŚĆ

- ILOŚĆ PACZEK

UKŁADY

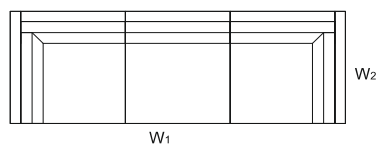
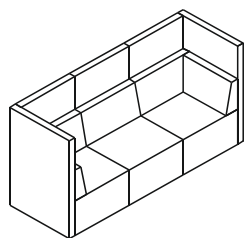

3XMM-PU + 3XMM-OW + 3XMM-PO + MM-OWP + MM-OWL + MM-PP + MM-PL

SYMBOL	WYMIARY					[mm]		⚖️	📦	📦		UWAGI
	W ₁	W ₂	D ₁	D ₂	H							
MM-3WP	2090	720	-	-	1145			129.3	0.967	13		

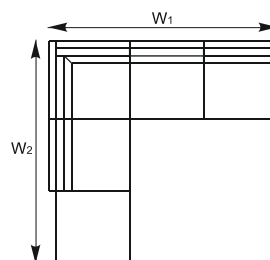
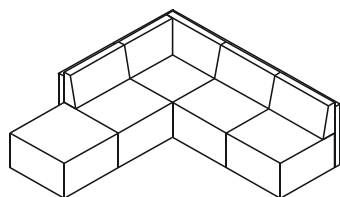

5xMM-PU + 4xMM-ON + MM-ONP + 4xMM-PO + MM-PL

SYMBOL	WYMIARY					[mm]		⚖️	📦	📦		UWAGI
	W ₁	W ₂	D ₁	D ₂	H							
MM-U01	2020	2020	-	-	770			136.6	1.217	15		

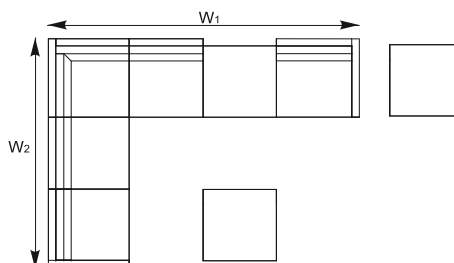
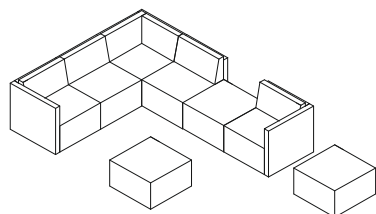

8xMM-PU + MM-ONP + 2xMM-ONL + 5xMM-ON + 5xMM-PO + MM-PL

SYMBOL	WYMIARY					[mm]		⚖️	📦	📦		UWAGI
	W ₁	W ₂	D ₁	D ₂	H							
MM-U02	2740	2090	-	-	770			217.0	1.885	22		

LEGENDA:

⚖️ - WAGA NETTO

📦 - OBJĘTOŚĆ

📦 - ILOŚĆ PACZEK

UKŁADY

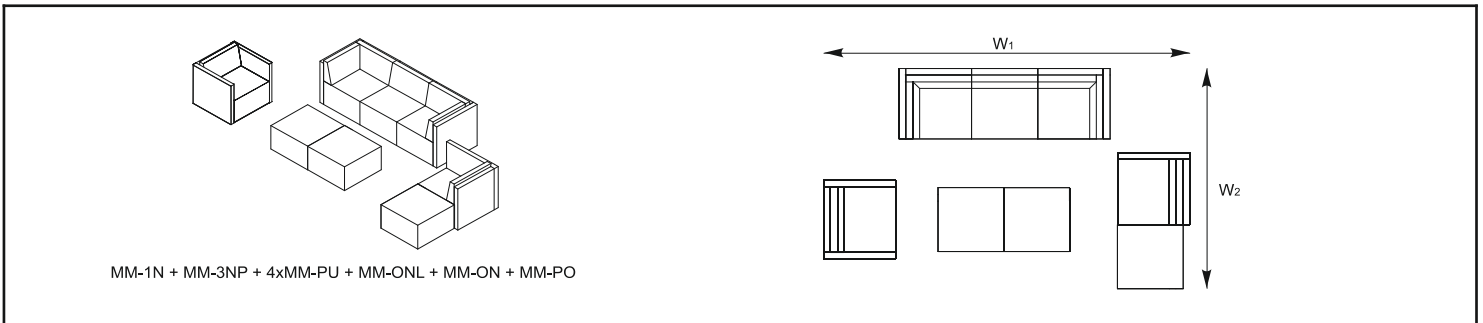

MM-1N + MM-3NP + 4xMM-PU + MM-ONL + MM-ON + MM-PO

SYMBOL	WYMIARY [mm]										UWAGI
	W ₁	W ₂	D ₁	D ₂	H						
MM-U03	3590	2390	-	-	770		238.3	1.986	25		

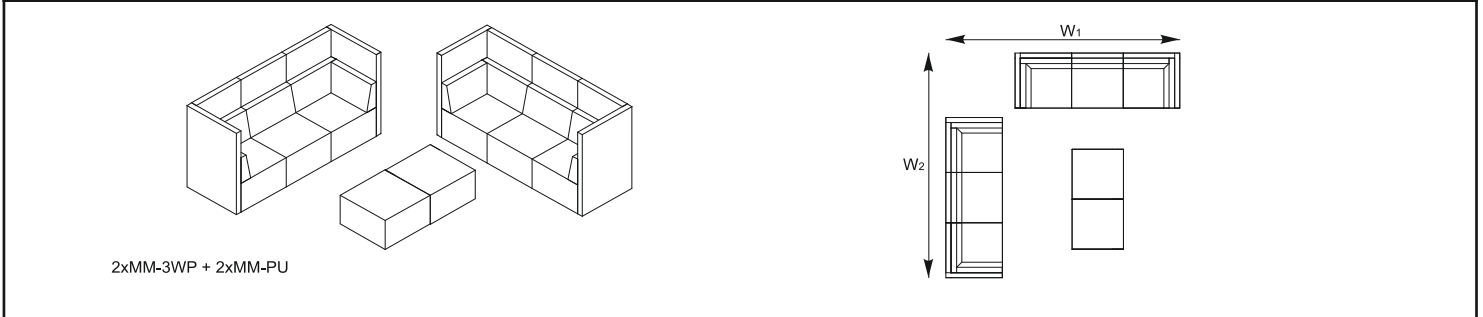

2xMM-3WP + 2xMM-PU

SYMBOL	WYMIARY [mm]										UWAGI
	W ₁	W ₂	D ₁	D ₂	H						
MM-U04	3140	3140	-	-	1145		292.6	2.288	28		

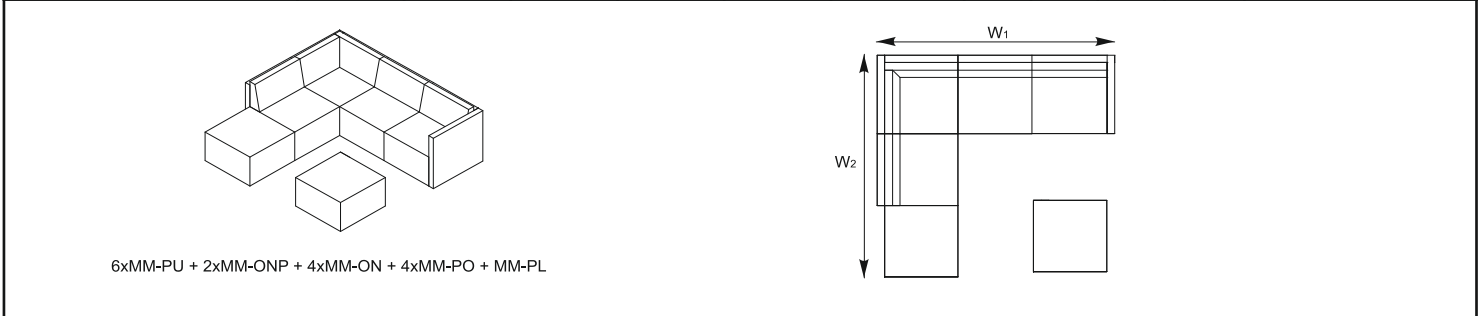

6xMM-PU + 2xMM-ONP + 4xMM-ON + 4xMM-PO + MM-PL

SYMBOL	WYMIARY [mm]										UWAGI
	W ₁	W ₂	D ₁	D ₂	H						
MM-U05	2090	2020	-	-	770		163.3	1.429	17		

LEGENDA:

- WAGA NETTO

- OBJĘTOŚĆ

- ILOŚĆ PACZEK

UKŁADY

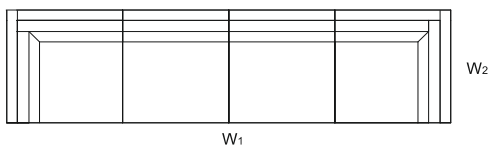
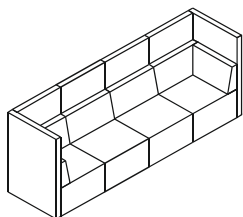

4xMM-PU + 4xMM-OW + 4xMM-PO + MM-PP + MMPL + MM-OWP + MM-OWL

SYMBOL	WYMIARY					[mm]	⚖️	📦	📦	UWAGI
	W ₁	W ₂	D ₁	D ₂	H					
MM-U06	2740	2390	-	-	1145		161.0	1.230	16	

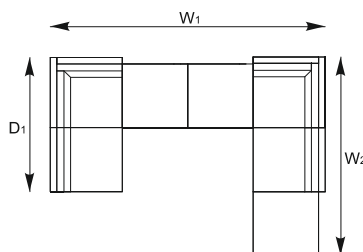
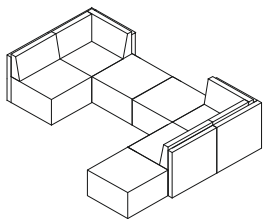

7xMM-PU + 4xMM-ON + 2xMM-ONP + 4xMM-PO + MM-PP + MM-PL



SYMBOL	WYMIARY					[mm]	⚖️	📦	📦	UWAGI
	W ₁	W ₂	D ₁	D ₂	H					
MM-U07	2740	2020			770		182.2	1.637	19	

LEGENDA:

⚖️ - WAGA NETTO

📦 - OBJĘTOŚĆ



📦 - ILOŚĆ PACZEK

WIDOK I RZUT OBIEKTU	WYMIARY [mm]			SYMBOL						UWAGI
	SZEROKO!*	G# BOKO!*	WYSOKO!*			kg	m3	szt		

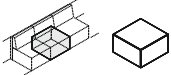
PUFA

	650	650	420	MM-PU		17.0	0.177	1		
---	-----	-----	-----	--------------	--	------	-------	---	--	--

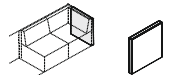
OPARCIE NISKIE

	650	70	700	MM-ON		8.1	0.032	1		
	720	70	700	MM-ONP		9.7	0.035	1		prawa
	720	70	700	MM-ONL		9.7	0.035	1		lewa

OPARCIE WYSOKIE

	650	70	1145	MM-OW		12.8	0.052	1		
	720	70	1145	MM-OWP		15.2	0.058	1		prawa
	720	70	1145	MM-OWL		15.2	0.058	1		lewa

PODUSZKI

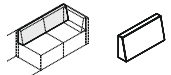
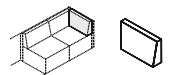
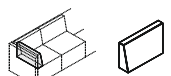
	650	150	350	MM-PO		1.9	0.034	1		
	574	150	350	MM-PP		1.9	0.030	1		prawa
	574	150	350	MM-PL		1.9	0.030	1		lewa

LEGENDA:

 - WAGA NETTO - OBJĘTOŚĆ - ILOŚĆ PACZEK



GRUPA III

CUZ1R

BLAZER



CUZ63



CUZ1X

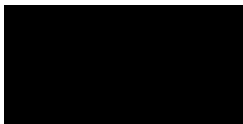

CUZ12



CUZ1G



CUZ39



CUZ02



CUZ1R



CUZ28



CUZ1L



CUZ1V



CUZ47

Dane techniczne

Skład	100% Virgin wool
Gramatura	460 gr/m ²
Odporność na ścieranie	50,000 cykli Martindale
Odporność na światło	ISO 105 - B02:2013 5
Odporność koloru na ścieranie	ISO 105 - X12:2002 (mokre/suche) 4
Trudnozapałność	BS EN 1021 - 1:2006 (papieros), BS EN 1021 - 2:2006 (zapałka), BS 7176:2007, UNI 9175 Klasa 1 IM, Norma B 3825 & A 3800-1

