

.mdd
Pracowniczy
v7.2021

Płyty wiórowe trzywarstwowe o gęstości:

- 690 - 750 kg/m³ dla płyt o grubości 12 mm
- 650 - 690 kg/m³ dla płyt o grubości 18 mm
- 610 - 630 kg/m³ dla płyt o grubości 28 mm
- 610 - 630 kg/m³ dla płyt o grubości 36 mm

Flow	3
Yan	6
Yan Z	14
Yan M	16
Yan - elementy modułowe do tworzenia stanowisk	18
Yan - akcesoria do biurk	20
Compact drive	21
Ogi Drive	24
Ogi	38
Ogi M	46
Ogi Q	49
Ogi U	52
Ogi Y	56
Elementy do rozbudowy - Ogi M, Ogi Q, Ogi U, Ogi Y	59
Ogi W	63
Ogi A	65
Ogi N	66
Ogi V	67
Ogi akcesoria	70
Ergonomic Master	71
Przystawki	79
Panele	85
Twin - panele tkaninowe	89
Sonic - panele akustyczne	92
Panele ściienne i sufitowe	98
Sonic - panele akustyczne ściienne	100
Bazalto - panele ściienne	100
Mix - panele ściienne	101
Mix - panele sufitowe	104
Klej do paneli Bazalto i Mix	104
Oslony przednie do biurk	105
Ścianki działowe	108
Stanowisko multimedialne	114

Zestawienie kolorystyczne - Flow

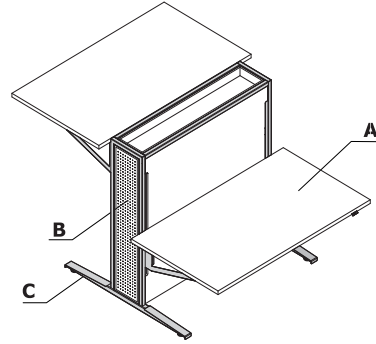

Materiał	Kolor	Biuurka														
		A - Blat	B - Korpus	C - Stelaż												
Płyta	08 - czarny	✓														
	26 - aluminium satynato	✓														
	31 - dąb kanadyjski	✓														
	39 - brzoza polarna	✓														
	64 - kakao	✓														
	67 - biały pastel	✓	✓													
	106 - orzech nizinny	✓														
	154 - antracyt	✓	✓													
	167 - dąb szary	✓														
	168 - dąb naturalny	✓														
	169 - dąb miodowy	✓														
	170 - akacja	✓														
	171 - orzech ciemny	✓														
	Metal	M009 - aluminium półmat RAL 9006			✓											
M015 - biały półmat RAL 9010				✓												
M115 - czarny półmat RAL 9005				✓												
M154 - antracyt półmat RAL 7043				✓												

Opis techniczny

- 1 Blat** - płyta melaminowana 28 mm, obrzeża ABS, nośność 50kg
- 2 Korpus:**
- **rama** - metal malowany proszkowo
 - **bok** - blacha perforowana; w kolorze stelaża
 - **wypełnienie** - płyta melaminowana 12mm
 - wymiary korpusu stałe dla wszystkich blatów
- 3 Stelaż** - metal malowany proszkowo
- 4 Stopa** - metal malowany proszkowo
- 5 Regulator poziomu** - regulacja w zakresie 5 mm
- 6 Elektryczna regulacja wysokości** - zakres 650 - 1300 mm:
- A** - podstawowy panel sterowania; czujność systemu antykolizyjnego ustawiona na poziomie Medium
- B** - OPCJA Z DOPŁATĄ - panel sterujący z pamięcią 4 wysokości; możliwość zmiany czułości systemu antykolizyjnego w obrębie 3 poziomów: Low, Medium, High
- C** - moduł bluetooth:
- kompatybilny zarówno z panelem A jak i z panelem B
 - możliwość zmiany czułości systemu antykolizyjnego w obrębie 3 poziomów: Low, Medium, High
 - sterowanie za pomocą aplikacji MDD Desk BT (do pobrania z Google Play lub App Store). Aplikacja posiada funkcję interwału czasowego, która informuje o konieczności zmiany położenia ciała (z siedzącej na stojącą lub ze stojącej na siedzącą)
 - oba blaty sterowane są jednym silnikiem; w tym samym czasie można sterować tylko jednym z blatów
- 7 Półka**
- 8 Zawieszka** - drut chromowany
- 9 Uchwyt na dokumenty A5** - drut chromowany

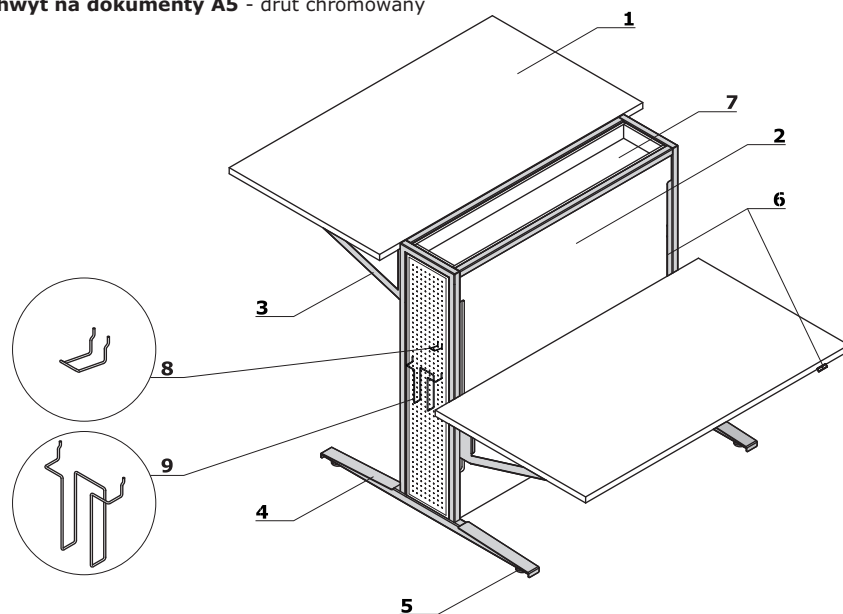

Specyfikacja techniczna stelaża

- 1 Specyfikacja techniczna stelaża**
- **Podnoszenie** - 40 mm/s
 - **Napęd** - 1 silnik z rozdziałem napędu
 - **Poziom hałasu** - < 48dB
 - **Zasilanie** - 230V, moc 256W
 - **Dyrektywy** - 206/95EC, UI508 1999, UL 1004 R7 06, WE DC 2004/108WE
 - tryb Stand - by 0.1W
 - **Zabezpieczenie** - system antykolizyjny

A

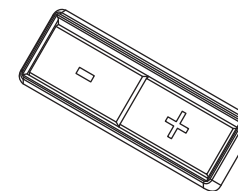

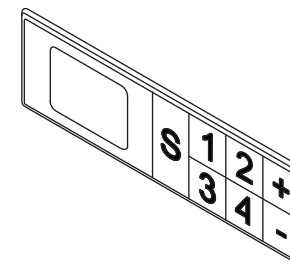

B

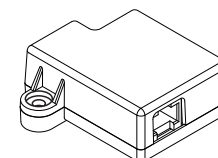

C

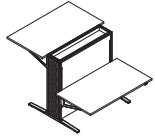
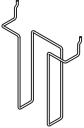

Biurka bench z elektryczną regulacją wysokości - sit-stand							
	Symbol	Cena netto PLN	Wymiary			Waga Obj. Opak.	Uwagi
			Szer.	Gł.	Wys.		
	FLW14	5180,-	1400	1900	1300	103.76 kg 0.584 m3 4 szt.	
	FLW16	5220,-	1600	1900	1300	114.4 kg 0.599 m3 4 szt.	
	FLW18	5270,-	1800	1900	1300	117.5 kg 0.615 m3 4 szt.	
	FLW24	5150,-	1400	1700	1300	99.9 kg 0.57 m3 4 szt.	
	FLW26	5200,-	1600	1700	1300	105 kg 0.584 m3 4 szt.	
	FLW28	5240,-	1800	1700	1300	111 kg 0.598 m3 4 szt.	
	Aksesoria						
	FLW1Z	70,-	170	45	225	0.2 kg 0.005 m3 1 szt.	
	FLW2Z	30,-	60	37	28	0.05 kg 0.001 m3 1 szt.	

Dodatkowa dopłata							
Panel sterujący z pamięcią 4 wysokości							
250,-							
250,-							
250,-							
250,-							
250,-							
250,-							

Zestawienie kolorystyczne - Yan

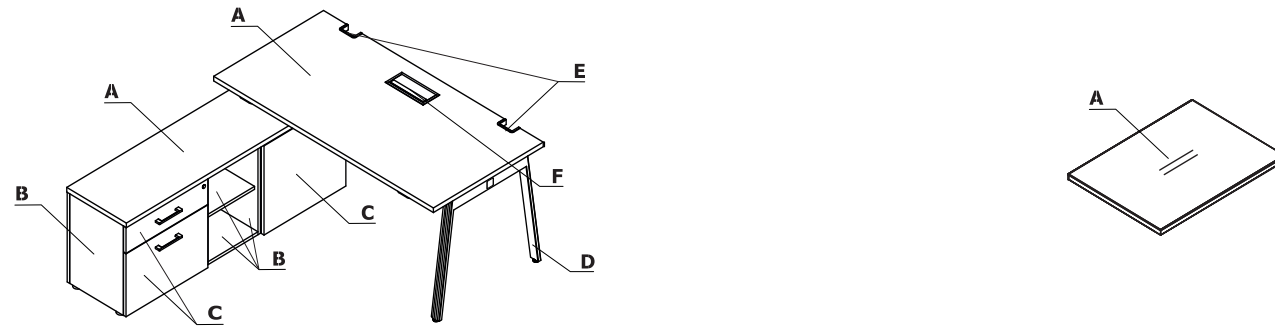

Materiał	Kolor	Biorka						Akcesoria									
		A - Blat	B - Korpus, wieniec dolny	C - Front	D - Stelaż	E - Przepusty kablowe	F - Mediabox	S120, S140, S160, S180	S89, S93	S11	S81, S94, S82						
Płyta	26 - aluminium satinato	✓	✓	✓		Aluminium											
	31 - dąb kanadyjski	✓	II grupa	✓		Beżowy											
	39 - brzoza polarna	✓	II grupa	✓		Beżowy											
	64 - kakao	✓	II grupa	✓		Beżowy											
	67 - biały pastel	✓	✓	✓		Biały											
	106 - orzech nizinny	✓	II grupa	✓		Brązowy											
	154 - antracyt	✓	✓	✓		Antracyt RAL 7043											
	08 - czarny	✓	✓	✓		Antracyt RAL 7043											
	167 - dąb szary	✓	II grupa	✓		Antracyt RAL 7043											
	168 - dąb naturalny	✓	II grupa	✓		Beżowy											
	169 - dąb miodowy	✓	II grupa	✓		Beżowy											
	170 - akacja	✓	II grupa	✓		Biały											
171 - orzech ciemny	✓	II grupa	✓		Antracyt RAL 7043												
Metal	M009 - aluminium półmat RAL 9006				✓		✓	✓									
	M015 - biały półmat RAL 9010				✓		✓	✓	✓								
	M154 - antracyt półmat RAL 7043				✓		✓	✓									
	M115 - czarny półmat RAL 9005				✓		✓	✓									
	Tworzywo - szary									✓							

Zestawienie kolorystyczne - Yan

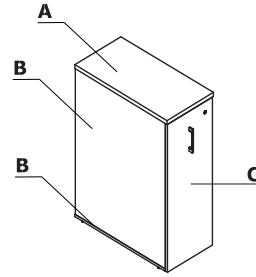

Materiał	Kolor	Szafy															
		A - Wieniec górny	B - Korpus, wieniec dolny	C - Front													
Płyta	26 - aluminium satinato	✓	✓	✓													
	31 - dąb kanadyjski	✓	II grupa ✓	✓													
	39 - brzoza polarna	✓	II grupa ✓	✓													
	64 - kakao	✓	II grupa ✓	✓													
	67 - biały pastel	✓	✓	✓													
	106 - orzech nizinny	✓	II grupa ✓	✓													
	154 - antracyt	✓	✓	✓													
	08 - czarny	✓	✓	✓													
	167 - dąb szary	✓	II grupa ✓	✓													
	168 - dąb naturalny	✓	II grupa ✓	✓													
	169 - dąb miodowy	✓	II grupa ✓	✓													
	170 - akacja	✓	II grupa ✓	✓													
	171 - orzech ciemny	✓	II grupa ✓	✓													

Blat

- 1 Blat** - płyta melaminowana 28 mm, obrzeża ABS
- 2 Przepust kablowy prostokątny** - wymiary otworu 90x48 mm

OPCJE Z DOPLATĄ:

- 3 Top access M05** - kolor top access dobiera się do kolorystyki stelaża
- 4 Mediabox M04** - 2xRJ45 (class E, cat. 6); + 1 x USB + 4 x 230V, kolor mediaboxu dobiera się do kolorystyki stelaża
- 5 Mediabox M04H** - 2xRJ45 (class E, cat. 6); + 1 x USB + 1 x HDMI + 4 x 230V, kolor mediaboxu dobiera się do kolorystyki stelaża
- 6 Wycięcie pod mediabox** - mediabox wybierany osobno

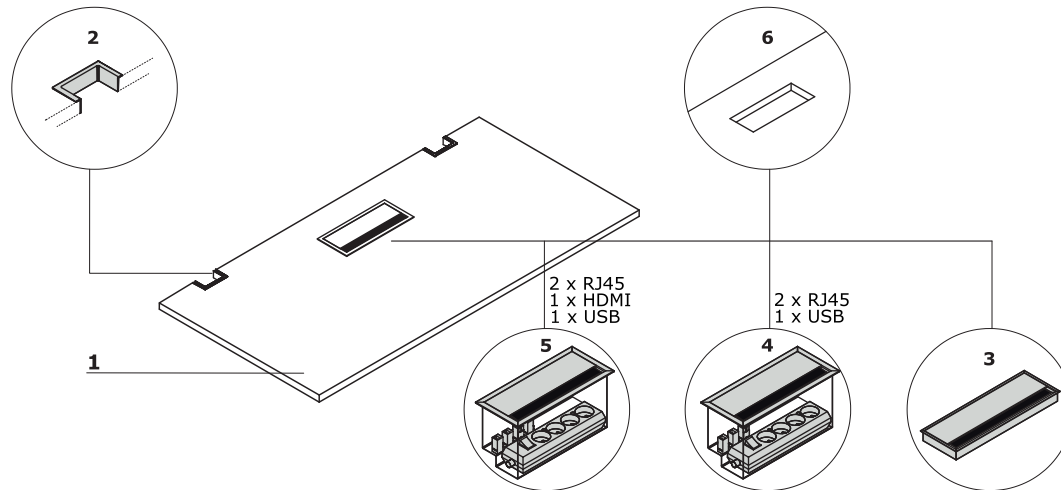

UWAGA - Przepusty kablowe są wymagane do montażu paneli

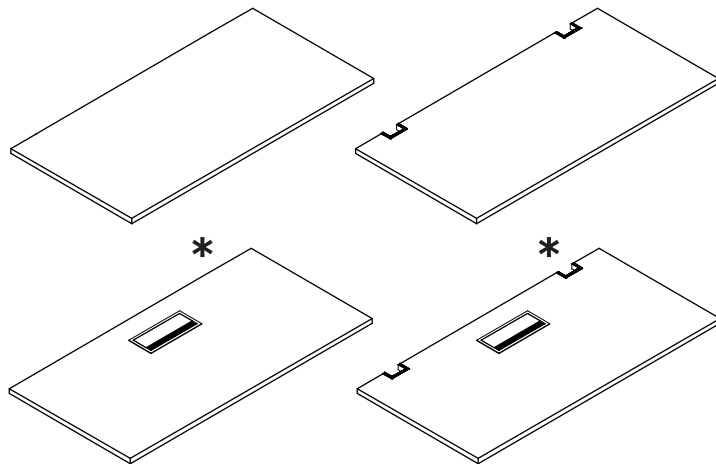
Blat - konfiguracje

opcja z dopłatą

Stelaż

- 1 Blat przesuwny** - zakres przesuwu 180 mm
- 2 Zatrzask blokujący** - składanie/rozkładanie blatu poprzez pociągnięcie zatrzasku
- 3 Zaślepka** - materiał PVC w kolorze stelaża - maskuje otwór do łączenia biurek
- 4 Podstawa blatu** - profil 40x40, montowany za pomocą jednego klucza - uniwersalna do wszystkich biurek Yan

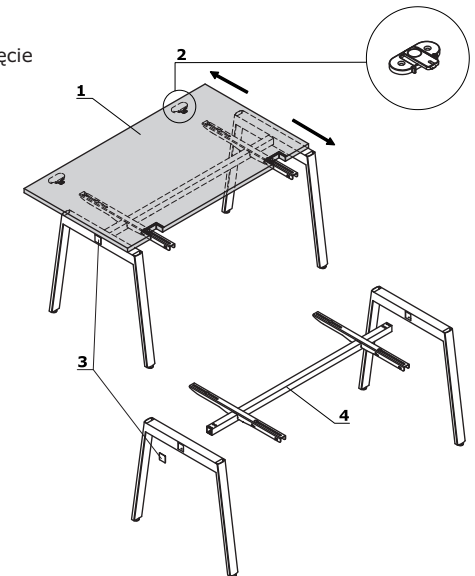

Stelaż

- **Yan Z** - metal malowany proszkowo, profil 60x30 mm
- **Yan M** - metal malowany proszkowo, profil 60 x 30 mm

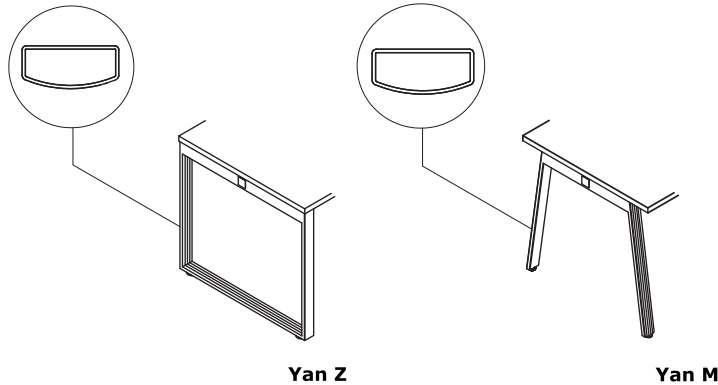

Uwaga - Szyna pod blatem zawsze w kolorze: M009 - aluminium półmat

Wymiary - biurka z szafką managerską (mm)

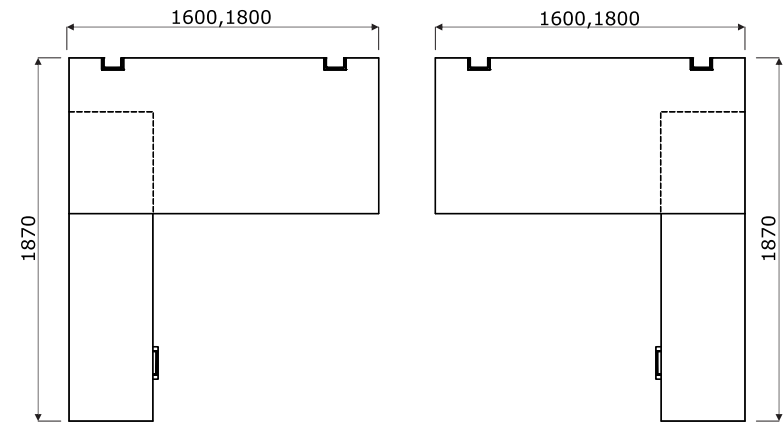

Biurko z szafką managerską

- 1 Blat** - płyta melaminowana 28 mm, obrzeża ABS
- 2 Wieniec górny** - płyta melaminowana 28 mm, obrzeża ABS
- 3 Korpus** - płyta melaminowana 18 mm, obrzeża ABS
- 4 Front** - płyta melaminowana 18 mm, obrzeża ABS
- 5 Wieniec dolny** - płyta melaminowana 18 mm, obrzeża ABS
- 6 Szuflada filowa** - płyta melaminowana 18 mm z dnem, prowadnice kulkowe, max obciążenie 45kg, wysunięcie 100%
- 7 Szuflada z dnem** - prowadnice kulkowe, max obciążenie 40 kg, wysunięcie 100%, mechanizm "push to open" (mieści komputer);
- 8 Przepusty kablowe** - Ø80 mm

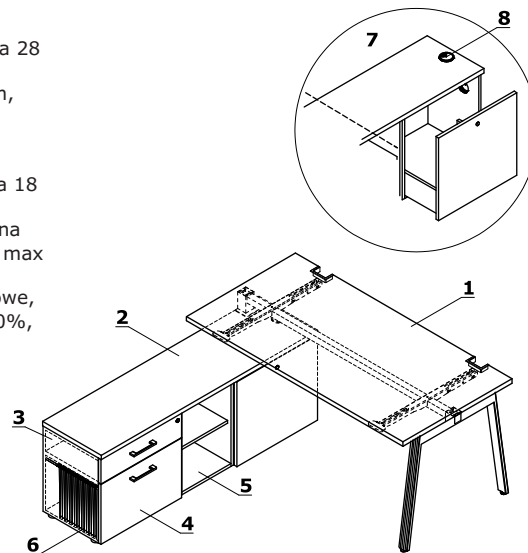

Przystawki do biurek

- 1 PLZ01** - przystawka z blatem przesuwным, noga typu Yan Z
- 2 PLM01** - przystawka z blatem przesuwным, noga typu Yan M

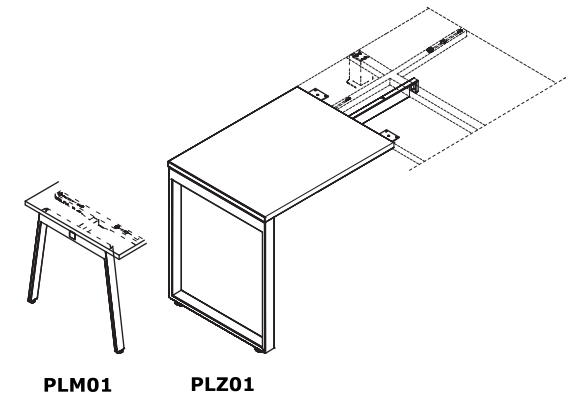

Akcesoria

- 1 **Szyna na kable** - metal malowany proszkowo
- 2 **Zawieszak do komputera**
- 3 **Pionowy organizer kablowy S93** - metal malowany proszkowo

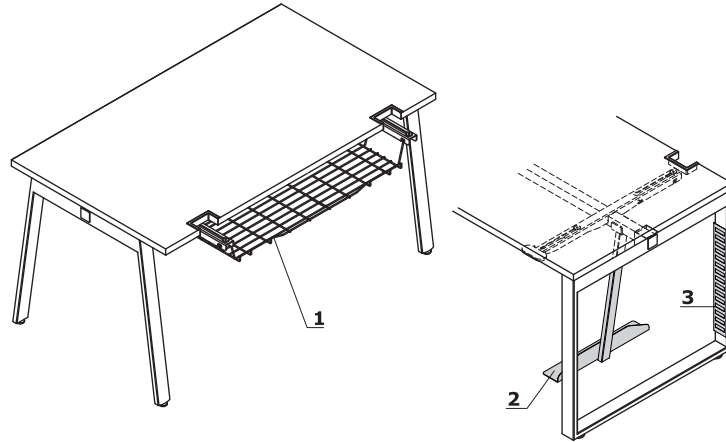

Kontenery stacjonarne (KDT) (mm)

- 1 **Wieniec górny** - płyta melaminowana 28 mm, obrzeża ABS
- 2 **Korpus** - płyta melaminowana 18 mm, obrzeża ABS
- 3 **Front** - płyta melaminowana 18 mm, obrzeża ABS
- 4 **Zamek centralny** - łamany klucz
- 5 **Szufłady metalowe** - prowadnice rolkowe, nośność 25 kg, wysunięcie 80%, blokada wysuwu drugiej szuflady; OPCJA Z DOPŁATĄ - system samodomyku, prowadnice kulkowe
- 6 **Regulatory poziomu** - regulacja w zakresie 10 mm
- 7 **Piórnik nakładany** - tworzywo czarne
- 8 **Szuflada filowa** - prowadnice kulkowe, max. obciążenie 30 kg, wysunięcie 100%, dla teczek A4 usytuowanie równoległe i prostopadłe do frontu

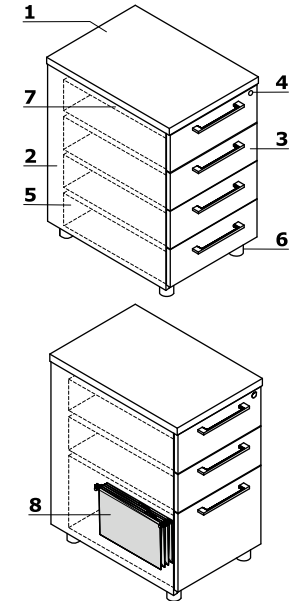

Tworzenie układów wielostanowiskowych

- 1 **Element początkowy** - biurko proste
- 2 **Element początkowy** - bench
- 3 **Elementy do tworzenia układów biurka**

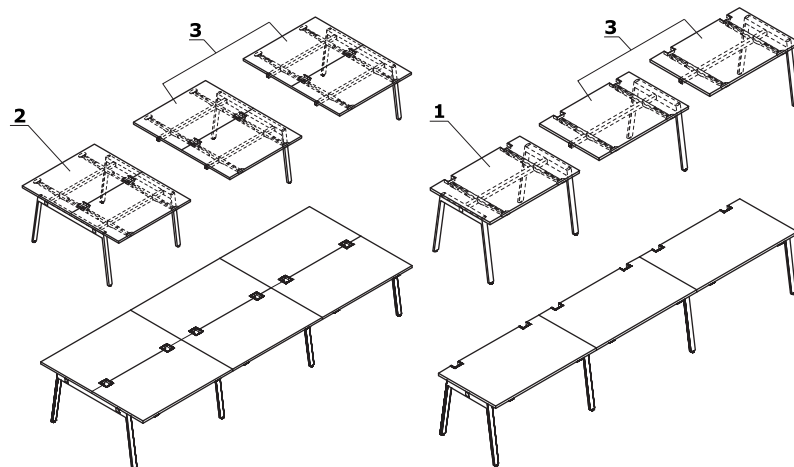

UWAGI - Analogicznie dla pozostałych systemów Yan

KDT..L

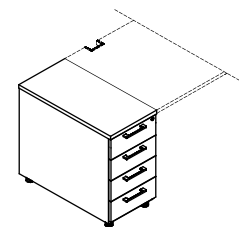

KDT..P

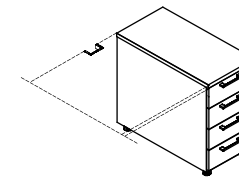

KDT..LP

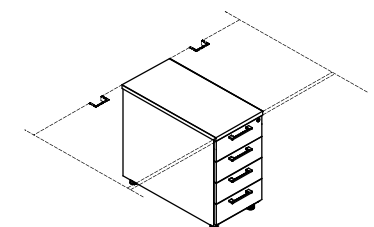

Kontenery Cargo

- 1 **Wieniec górny** - płyta melaminowana 28 mm, obrzeża ABS
- 2 **Korpus** - płyta melaminowana 18 mm, obrzeża ABS
- 3 **Wieniec dolny** - płyta melaminowana 18 mm, obrzeża ABS
- 4 **Regulatory poziomu** - regulacja w zakresie 10 mm
- 5 **Ruchoma przegroda pionowa** - umożliwia organizację przestrzeni
- 6 **OPCJA Z DOPLATĄ** - Szuflada - płyta melaminowana 18 mm, max. obciążenie 35 kg, wysunięcie 100%, możliwość wieszania teczek zawieszkowych, prowadnice kulkowe
- 7 **Kółka** - Ø75 mm
- 8 **Front** - płyta melaminowana 18 mm, obrzeża ABS
- 9 **Półka** - płyta melaminowana 18 mm, zabezpieczenie przed przypadkowym wysunięciem, obrzeża ABS
- 10 **Brak ściany tylnej**
- 11 **Uchwyt** - aluminium
- 12 **Zamek patentowy**
- 13 **Piórnik nakładany** - tworzywo czarne
- 14 **Ściana tylna** - płyta melaminowana 18 mm, obrzeża ABS

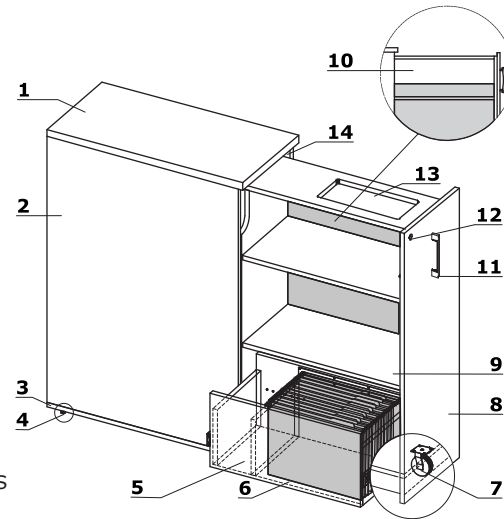

- **KCD80L** - dostęp do półek z lewej strony
- **KCD80P** - dostęp do półek z prawej strony
- **KCD80SP** - dostęp do półek z prawej strony, możliwość przeprowadzenia kabli wewnątrz kontenera
- **KCD80SL** - dostęp do półek z lewej strony, możliwość przeprowadzenia kabli wewnątrz kontenera

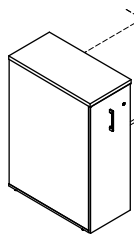

KCD80L

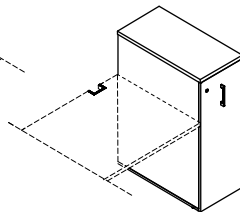

KCD80P

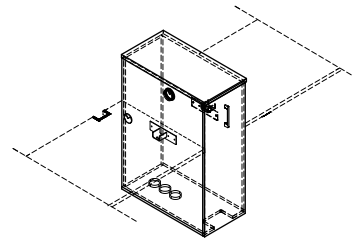

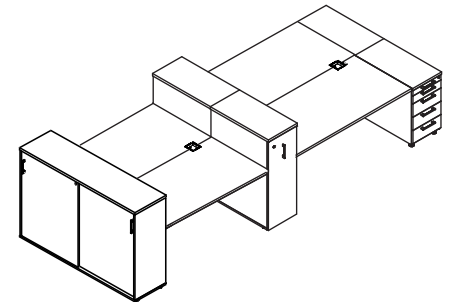
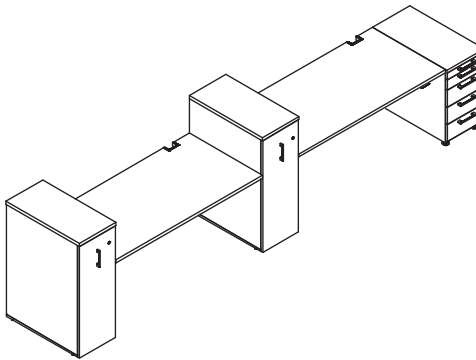
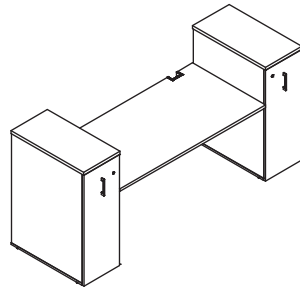
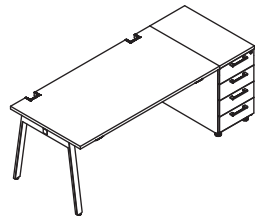
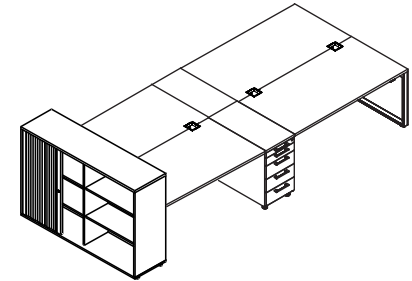
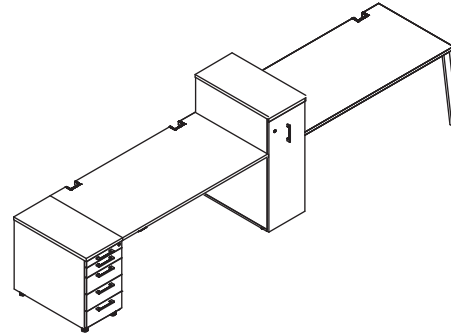
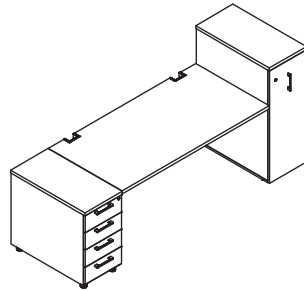
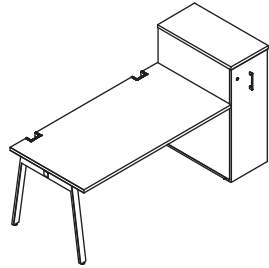
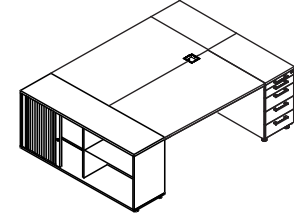
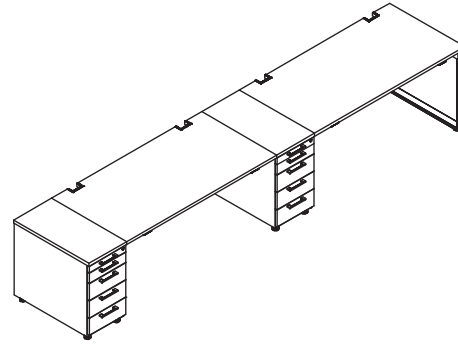
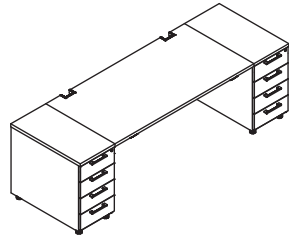
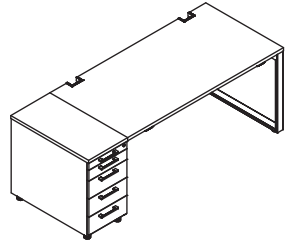

KCD80SL/KCD80SP

Przykładowe konfiguracje

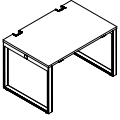
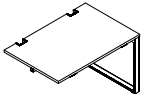
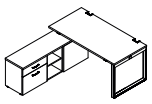
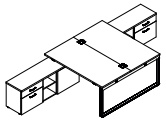

Biuorka proste							
	Symbol	Cena netto PLN	Wymiary			Waga Obj. Opak.	Uwagi
			Szer.	Gł.	Wys.		
	ZBN02	1460,-	1200	800	740	47 kg 0.143 m3 5 szt.	
	ZBN04	1500,-	1400	800	740	50.5 kg 0.149 m3 5 szt.	
	ZBN06	1530,-	1600	800	740	55.05 kg 0.155 m3 5 szt.	
	ZBN08	1610,-	1800	800	740	56.5 kg 0.162 m3 5 szt.	
Elementy do tworzenia układów biurek							
	ZBN02L	1040,-	1200	800	740	38 kg 0.093 m3 4 szt.	mocowanie wyłącznie do krawędzi 800mm
	ZBN04L	1080,-	1400	800	740	41.5 kg 0.099 m3 4 szt.	
	ZBN06L	1120,-	1600	800	740	46.05 kg 0.105 m3 4 szt.	
	ZBN08L	1190,-	1800	800	740	47.5 kg 0.112 m3 4 szt.	
Biuorka z szafką managerską							
	ZBN01	3760,-	1600	1870	740	142.25 kg 0.483 m3 9 szt.	uniwersalne (lewe / prawe);
	ZBN03	3840,-	1800	1870	740	143.7 kg 0.489 m3 9 szt.	
	ZBN05	7270,-	1600	3740	740	278.5 kg 0.983 m3 16 szt.	
	ZBN07	7440,-	1800	3740	740	281.4 kg 0.996 m3 16 szt.	

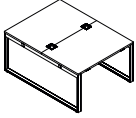
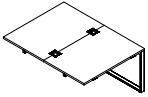

Dodatkowa dopłata							
Mediabox M04H	Mediabox M04	Top access	II grupa cenowa	Wycięcie pod mediabox			
315,-	295,-	105,-		11,-			
315,-	295,-	105,-		11,-			
315,-	295,-	105,-		11,-			
315,-	295,-	105,-		11,-			
315,-	295,-	105,-		11,-			
315,-	295,-	105,-		11,-			
315,-	295,-	105,-	80,-	11,-			
315,-	295,-	105,-	80,-	11,-			
630,-	590,-	210,-	160,-	22,-			
630,-	590,-	210,-	160,-	22,-			

Bierka typu bench							
	Symbol	Cena netto PLN	Wymiary			Waga Obj. Opak.	Uwagi
			Szer.	Gł.	Wys.		
	ZBN12	2440,-	1200	1600	740	82 kg 0.321 m3 7 szt.	
	ZBN14	2520,-	1400	1600	740	89 kg 0.333 m3 7 szt.	
	ZBN16	2600,-	1600	1600	740	98.1 kg 0.345 m3 7 szt.	
	ZBN18	2770,-	1800	1600	740	101 kg 0.358 m3 7 szt.	
Elementy do tworzenia układów biurek							
	ZBN12L	1840,-	1200	1600	740	70 kg 0.204 m3 6 szt.	
	ZBN14L	1930,-	1400	1600	740	77 kg 0.216 m3 6 szt.	
	ZBN16L	2000,-	1600	1600	740	86.1 kg 0.228 m3 6 szt.	
	ZBN18L	2160,-	1800	1600	740	89 kg 0.241 m3 6 szt.	
Przystawki do biurek							
	PL180	480,-	1600	600	28	33.45 kg 0.051 m3 3 szt.	
	PLZ01	830,-	600	800	740	21.65 kg 0.051 m3 5 szt.	

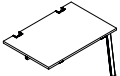
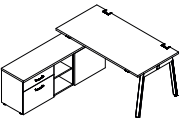
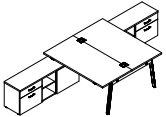
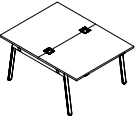
Dodatkowa dopłata							
Mediabox M04H	Mediabox M04	Top access	Wycięcie pod mediabox				
630,-	590,-	210,-	22,-				
630,-	590,-	210,-	22,-				
630,-	590,-	210,-	22,-				
630,-	590,-	210,-	22,-				
630,-	590,-	210,-	22,-				
630,-	590,-	210,-	22,-				

Biurka proste							
	Symbol	Cena netto PLN	Wymiary			Waga Obj. Opak.	Uwagi
			Szer.	Gł.	Wys.		
	BLN02	1330,-	1200	800	740	45 kg 0.134 m3 5 szt.	
	BLN04	1360,-	1400	800	740	48.5 kg 0.14 m3 5 szt.	
	BLN06	1400,-	1600	800	740	53.05 kg 0.146 m3 5 szt.	
	BLN08	1490,-	1800	800	740	54.5 kg 0.153 m3 5 szt.	
Elementy do tworzenia układów biurek							
	BLN02L	970,-	1200	800	740	37 kg 0.089 m3 4 szt.	mocowanie wyłącznie do krawędzi 800mm
	BLN04L	1010,-	1400	800	740	40.5 kg 0.095 m3 4 szt.	
	BLN06L	1050,-	1600	800	740	45.05 kg 0.101 m3 4 szt.	
	BLN08L	1140,-	1800	800	740	46.5 kg 0.107 m3 4 szt.	
Biurka z szafką managerską							
	BLN01	3690,-	1600	1870	740	141.25 kg 0.478 m3 9 szt.	uniwersalne (lewe / prawe);
	BLN03	3770,-	1800	1870	740	142.7 kg 0.485 m3 9 szt.	
	BLN05	7160,-	1600	3740	740	278.5 kg 0.941 m3 16 szt.	
	BLN07	7320,-	1800	3740	740	281.4 kg 0.954 m3 16 szt.	
Biurka typu bench							
	BLN12	2190,-	1200	1600	740	82 kg 0.237 m3 7 szt.	
	BLN14	2260,-	1400	1600	740	89 kg 0.25 m3 7 szt.	

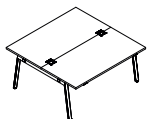
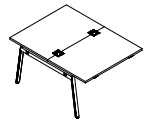

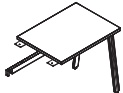
Dodatkowa dopłata							
Mediabox M04H	Mediabox M04	Top access	II grupa cenowa	Wycięcie pod mediabox			
315,-	295,-	105,-		11,-			
315,-	295,-	105,-		11,-			
315,-	295,-	105,-		11,-			
315,-	295,-	105,-		11,-			
315,-	295,-	105,-		11,-			
315,-	295,-	105,-	80,-	11,-			
315,-	295,-	105,-	80,-	11,-			
630,-	590,-	210,-	160,-	22,-			
630,-	590,-	210,-	160,-	22,-			
630,-	590,-	210,-		22,-			
630,-	590,-	210,-		22,-			

Bierka typu bench							
	Symbol	Cena netto PLN	Wymiary			Waga Obj. Opak.	Uwagi
			Szer.	Gł.	Wys.		
	BLN16	2350,-	1600	1600	740	101.3 kg 0.276 m3 9 szt.	
	BLN18	2520,-	1800	1600	740	101 kg 0.275 m3 7 szt.	
Elementy do tworzenia układów biurek							
	BLN12L	1720,-	1200	1600	740	70 kg 0.162 m3 6 szt.	
	BLN14L	1790,-	1400	1600	740	77 kg 0.174 m3 6 szt.	
	BLN16L	1880,-	1600	1600	740	86.1 kg 0.186 m3 6 szt.	
	BLN18L	2040,-	1800	1600	740	89 kg 0.199 m3 6 szt.	
Przystawki do biurek							
	PL180	480,-	1600	600	28	33.45 kg 0.051 m3 3 szt.	
	PLM01	805,-	600	800	740	20.45 kg 0.057 m3 5 szt.	

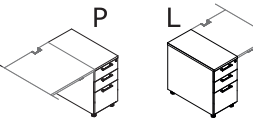
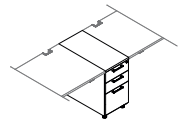
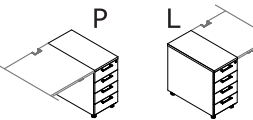
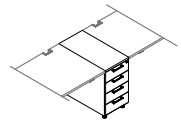
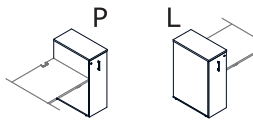
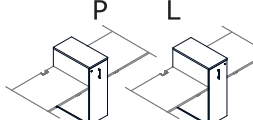



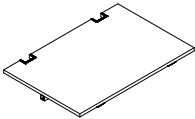
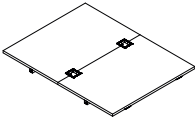

Dodatkowa dopłata							
Mediabox M04H	Mediabox M04	Top access	Wycięcie pod mediabox				
630,-	590,-	210,-	22,-				
630,-	590,-	210,-	22,-				
630,-	590,-	210,-	22,-				
630,-	590,-	210,-	22,-				

Kontenery stacjonarne (KDT) (mm)							
	Symbol	Cena netto PLN	Wymiary			Waga Obj. Opak.	Uwagi
			Szer.	Gł.	Wys.		
	KDT73P	990,-	402	800	740	32 kg 0.257 m3 2 szt.	prawy
	KDT73L	990,-	402	800	740	32 kg 0.257 m3 2 szt.	lewy
	KDT73LP	1070,-	402	800	740	33 kg 0.259 m3 3 szt.	środkowy
	KDT74P	955,-	402	800	740	32 kg 0.257 m3 2 szt.	prawy
	KDT74L	955,-	402	800	740	32 kg 0.257 m3 2 szt.	lewy
	KDT74LP	1050,-	402	800	740	33 kg 0.259 m3 3 szt.	środkowy
Kontenery Cargo							
	KCD80P	1760,-	402	800	1129	72 kg 0.416 m3 2 szt.	prawy
	KCD80L	1760,-	402	800	1129	74 kg 0.416 m3 2 szt.	lewy
	KCD80SP	1850,-	402	800	1129	75 kg 0.418 m3 3 szt.	środkowy - dostęp do półek z prawej strony
	KCD80SL	1850,-	402	800	1129	75 kg 0.418 m3 3 szt.	środkowy - dostęp do półek z lewej strony

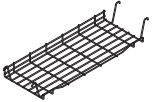
Dodatkowa dopłata							
II grupa cenowa	System samodomylku	Prowadnice kulkowe	Szufłada				
105,-	100,-	150,-					
105,-	100,-	150,-					
105,-	100,-	150,-					
105,-	120,-	300,-					
105,-	120,-	300,-					
105,-	120,-	300,-					
105,-			480,-				
105,-			480,-				
105,-			480,-				
105,-			480,-				

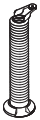

Blaty pojedyncze							
	Symbol	Cena netto PLN	Wymiary			Waga Obj. Opak.	Uwagi
			Szer.	Gł.	Wys.		
	BZB02	550,-	1200	800	83	30.6 kg 0.051 m3 4 szt.	
	BZB04	580,-	1400	800	83	34.1 kg 0.057 m3 4 szt.	
	BZB06	615,-	1600	800	83	38.65 kg 0.063 m3 4 szt.	
	BZB08	685,-	1800	800	83	40.1 kg 0.07 m3 4 szt.	
Blaty podwójne							
	BZB12	1085,-	1200	1600	83	61.2 kg 0.102 m3 7 szt.	
	BZB14	1150,-	1400	1600	83	68.2 kg 0.114 m3 7 szt.	
	BZB16	1215,-	1600	1600	83	77.3 kg 0.126 m3 7 szt.	
	BZB18	1355,-	1800	1600	83	80.2 kg 0.139 m3 7 szt.	
Uchwyty							
	HST2	92,-	160	110	20	0.2 kg 0 m3 1 szt.	uchwyty Standard (2 szt.)

Dodatkowa dopłata							
Mediabox M04H	Mediabox M04	Top access	Wycięcie pod mediabox				
315,-	295,-	105,-	11,-				
315,-	295,-	105,-	11,-				
315,-	295,-	105,-	11,-				
315,-	295,-	105,-	11,-				
630,-	590,-	210,-	22,-				
630,-	590,-	210,-	22,-				
630,-	590,-	210,-	22,-				
630,-	590,-	210,-	22,-				

Akcesoria							
	Symbol	Cena netto PLN	Wymiary			Waga Obj. Opak.	Uwagi
			Szer.	Gł.	Wys.		
	S120	220,-	716	244	98	0.9 kg 0.018 m3 1 szt.	do biurek o szer. 1200mm
	S140	225,-	916	244	98	1.2 kg 0.023 m3 1 szt.	do biurek o szer. 1400mm
	S160	235,-	1116	244	98	1.4 kg 0.028 m3 1 szt.	do biurek o szer. 1600mm
	S180	240,-	1316	244	98	1.7 kg 0.033 m3 1 szt.	do biurek o szer. 1800mm
	M04	295,-	275	120	140	1.6 kg 0.008 m3 1 szt.	4x230V, 2xRJ45, 1xUSB
	M04H	315,-	275	120	140	2 kg 0.013 m3 2 szt.	4x230V, 2xRJ45, 1xUSB, 1xHDMI
	M05	105,-	275	120	25	0.3 kg 0.002 m3 1 szt.	top access
	S81	155,-	140	70	750	1.1 kg 0.008 m3 1 szt.	przewodzenie kabli (kręgosłup); kolor 09 - aluminium, do biurek bez regulacji wysokości
	S94	249,-	140	140	750	0.95 kg 0.004 m3 1 szt.	przewodzenie kabli (sprężyna), 09 - aluminium
	S93	105,-	470	62	34	1 kg 0.002 m3 1 szt.	pionowy organizer kablowy, pasuje do biurek Ogi Drive, Yan, Ogi A, Ogi Q i Ogi U o profilu 60 mm
	S82	80,-	1000	70	35	1 kg 0.005 m3 1 szt.	grzebień do mocowania kabli pod blatem, 09 - aluminium

Dodatkowa dopłata

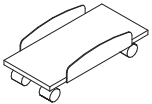
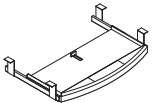
--	--	--	--	--	--	--	--	--	--	--	--	--	--	--	--	--	--	--	--	--

Akcesoria							
	Symbol	Cena netto PLN	Wymiary			Waga Obj. Opak.	Uwagi
			Szer.	Gł.	Wys.		
	S89	275,-	116	460	549	3.5 kg 0.005 m3 1 szt.	pasuje do biurek Ogi Drive, Ogi W, Ogi M, Ogi Q, Ogi U oraz Ogi Y, z wyjątkiem Ogi A, Ogi N, Ogi V
	S73	179,-	220	470	148	2.9 kg 0.002 m3 1 szt.	wózek do komputera, 26 - aluminium satinato
	C01	149,-	610	400	85	1.3 kg 0.01 m3 1 szt.	półka pod klawiaturę do biurek o głębokości 800 mm, z wyjątkiem biurek Drive, 02 - szary
	S11	65,-	45	50	57	0.2 kg 0 m3 1 szt.	wieszak na torebkę, M015 - biały półmat

Dodatkowa dopłata							

Zestawienie kolorystyczne - Compact drive

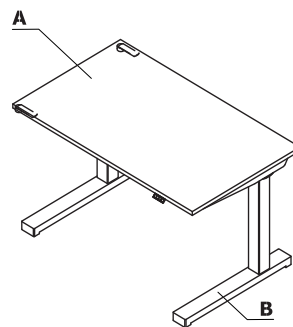

Materiał	Kolor	Biuurka														
		A - Blat	B - Stelaż													
Płyta	26 - aluminium satinato	✓*														
	31 - dąb kanadyjski	✓														
	39 - brzoza polarna	✓														
	64 - kakao	✓														
	67 - biały pastel	✓*														
	106 - orzech nizinny	✓														
	154 - antracyt	✓*														
	08 - czarny	✓*														
	167 - dąb szary	✓														
	168 - dąb naturalny	✓														
	169 - dąb miodowy	✓														
	170 - akacja	✓														
	171 - orzech ciemny	✓														
Metal	M009 - aluminium półmat RAL 9006		✓													
	M015 - biały półmat RAL 9010		✓													
	M154 - antracyt półmat RAL 7043		✓													
	M115 - czarny półmat RAL 9005		✓													

* UWAGA - OPCJA Z DOPLATĄ - obrzeże blatu, kolor: jesion naturalny

Opis techniczny

- 1 **Blat** - płyta melaminowana 18 mm, obrzeża ABS
- 2 **Kółka transportowe** - przemieszczanie biurka w pozycji złożonej
- 3 **Stelaż elektryczny** - metal malowany proszkowo, udźwig 100 kg, kolumna teleskopowa, składana
- 4 **Stopa:**
 - stopki - tylko przy nodze prawej
 - kółka transportowe - tylko przy nodze lewej
- 5 **Panel sterujący** - płynna regulacja wysokości:
 - A** - podstawowy panel sterowania; czujność systemu antykolizyjnego ustawiona na poziomie Medium
 - B** - OPCJA Z DOPŁATĄ - panel sterujący z pamięcią 4 wysokości; możliwość zmiany czułości systemu antykolizyjnego w obrębie 3 poziomów: Low, Medium, High
 - C** - OPCJA Z DOPŁATĄ - moduł bluetooth
 - kompatybilny zarówno z panelem A jak i z panelem B
 - możliwość zmiany czułości systemu antykolizyjnego w obrębie 3 poziomów: Low, Medium, High
 - sterowanie za pomocą aplikacji MDD Desk BT (do pobrania z Google Play lub App Store). Aplikacja posiada funkcję interwału czasowego, która informuje o konieczności zmiany położenia ciała (z siedzącej na stojącą lub ze stojącej na siedzącą)

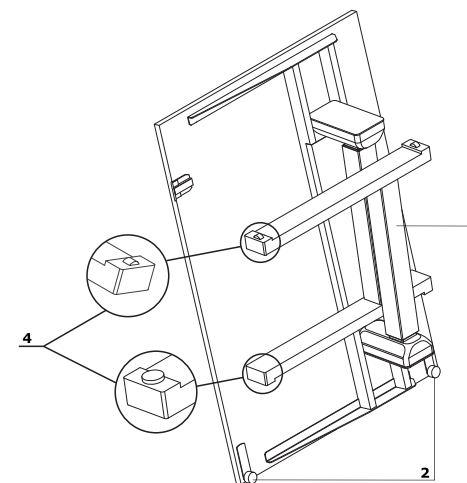
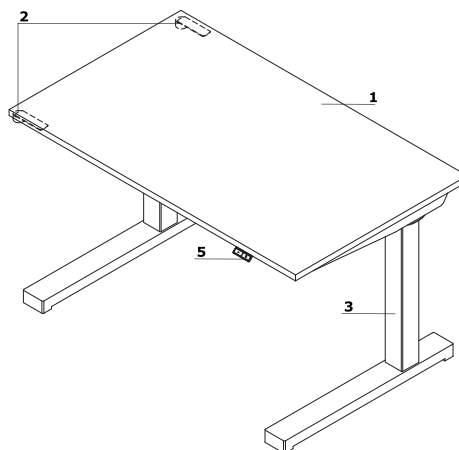

Specyfikacja techniczna stelaża

- Podnoszenie - 40 mm/s Super Soft - Start - Stop
- Napęd - 2 silniki z synchronizacją, sterowane przez mikroprocesor z zabezpieczeniem przed przeciążeniem, termiczny czujnik pracy silnika
- Poziom hałasu - < 48dB
- Zabezpieczenie - system antykolizyjny
- Normy - EN 527-2
- Dyrektywy - 206/95EC, UI508 1999, UL 1004 R7 06, WE DC 2004/108WE
- Zasilanie - 230V, moc 300W, zużycie w trybie Stand - by 0.3W

A

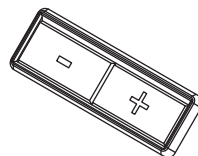

B

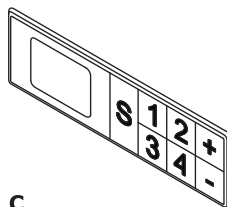

C

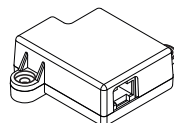

Stelaż

- 1 **Stelaż elektryczny** - regulacja w zakresie 540–1190 mm - sit-stand, metal malowany proszkowo, 3 nakładane profile 50x50 mm, 55x55 mm i 60x60 mm

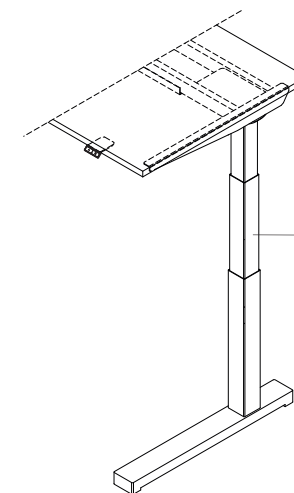

Uwaga - Biurko dostarczane w formie zmontowanej, ze złożonym stelażem (rozłożenie stelaża nie wymaga użycia narzędzi)

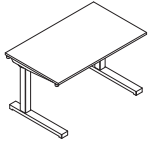
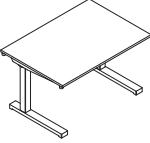
Biuorka							
	Symbol	Cena netto PLN	Wymiary			Waga Obj. Opak.	Uwagi
			Szer.	Gł.	Wys.		
	CDR60	2900,-	1000	600	1225 575	33.3 kg 0.126 m3 1 szt.	
	CDR62	2920,-	1200	600	1225 575	34.85 kg 0.151 m3 1 szt.	
	CDR64	2940,-	1400	600	1225 575	38.45 kg 0.176 m3 1 szt.	
	CDR70	2920,-	1000	700	1225 575	35.75 kg 0.147 m3 1 szt.	
	CDR72	2940,-	1200	700	1225 575	38 kg 0.176 m3 1 szt.	
	CDR74	2960,-	1400	700	1225 575	43 kg 0.204 m3 1 szt.	

Dodatkowa dopłata						
Panel sterujący z pamięcią 4 wysokości	Obrzeże naturalne	Moduł bluetooth				
125,-	105,-	260,-				
125,-	105,-	260,-				
125,-	105,-	260,-				
125,-	105,-	260,-				
125,-	105,-	260,-				
125,-	105,-	260,-				

Zestawienie kolorystyczne - Ogi Drive

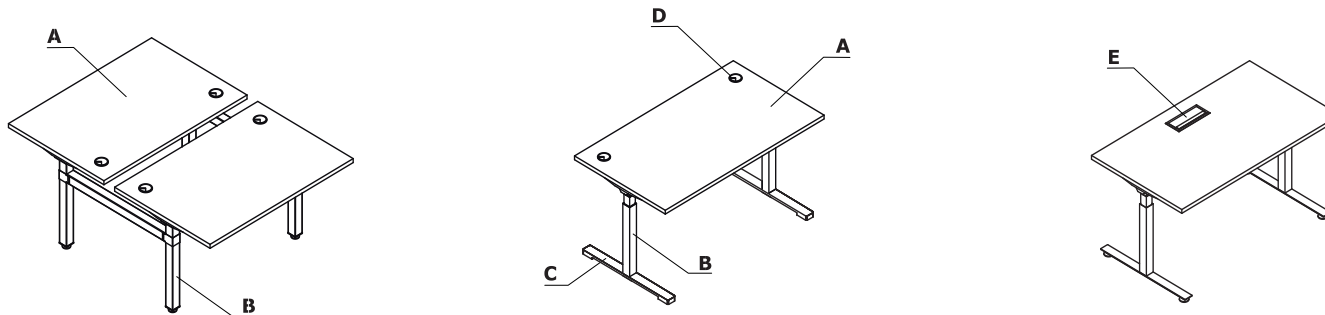

Materiał	Kolor	Biuurka																
		A - Blat	B - Stelaż	C - Stopa Yan Drive	D - Przepusty kablowe	E - Mediabox												
Płyta	26 - aluminium satinato	✓			Aluminium													
	31 - dąb kanadyjski	✓			Beżowy													
	39 - brzoza polarna	✓			Beżowy													
	64 - kakao	✓			Beżowy													
	67 - biały pastel	✓			Biały													
	106 - orzech nizinny	✓			Czarny													
	154 - antracyt	✓			Czarny													
	08 - czarny	✓			Czarny													
	167 - dąb szary	✓			Czarny													
	168 - dąb naturalny	✓			Beżowy													
	169 - dąb miodowy	✓			Beżowy													
	170 - akacja	✓			Beżowy													
	171 - orzech ciemny	✓			Czarny													
Metal	M009 - aluminium półmat RAL 9006		✓	✓		✓												
	M015 - biały półmat RAL 9010		✓	✓		✓												
	M154 - antracyt półmat RAL 7043		✓	✓		✓												
	M115 - czarny półmat RAL 9005		✓	✓		✓												
	25 - aluminium polerowane				✓*													

* stopa - dopłata 92 zł za 1 szt., do ceny biurka 184zł (komplet 2szt.)

Zestawienie kolorystyczne - Ogi Drive

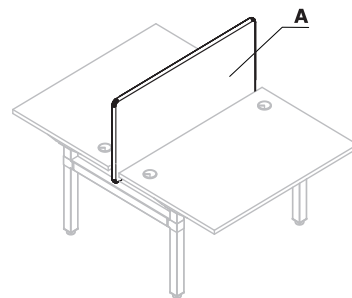

Materiał	Kolor	Panele												
		A - Sonic												
Tkanina	Nemo	✓												
	Runner	II grupa ✓												
	Medley	II grupa ✓												
	**Atlantic	II grupa ✓												
	Mica	II grupa ✓												
	Go Check	II grupa ✓												
	Vita	II grupa ✓												
	Charles	II grupa ✓												
	Xtreme	III grupa ✓												
	Synergy	III grupa ✓												
	***Silvertex	III grupa ✓												
	*Tkanina powierzona	II grupa ✓												
	Atlas	IV grupa ✓												
	Field2	IV grupa ✓												

* Zastosowanie tkaniny powierzonej wymaga przeprowadzenia prób tapicerskich, w celu sprawdzenia możliwości wykonawczych

*** Istnieje możliwość zamówienia produktu w pełnej kolorystyce Silvertex wg wzornika Spradling w terminie nie krótszym niż 15 dni roboczych

** Istnieje możliwość zamówienia produktu w pełnej kolorystyce Atlantic wg wzornika Gabriel w terminie nie krótszym niż 7 dni roboczych

Blat

- 1 Blat** - płyta melaminowana 28 mm, obrzeża ABS

OPCJE Z DOPLATĄ:

- 2 Przepust kablowy** - 2 szt., Ø 80 mm
3 Mediabox M04H - 2xRJ45 (class E, cat. 6); + 1 x USB + 1 x HDMI + 4 x 230V, kolor mediaboxu dobiera się do kolorystyki stelaża
4 Mediabox M04 - 2xRJ45 (class E, cat. 6); + 1 x USB + 4 x 230V, kolor mediaboxu dobiera się do kolorystyki stelaża
5 Mediabox M07 - 1 x 230V + 1 x USB charger + 1 x RJ45, kolor: czarny, biały, montowany zamiast istniejącego przepustu kablowego Ø80 mm (PK80)
6 Top access M05 - kolor top access dobiera się do kolorystyki stelaża
7 Wycięcie kablowe - szerokość otworu jest proporcjonalna do szerokości blatu
8 Wycięcie pod mediabox - mediabox wybierany osobno

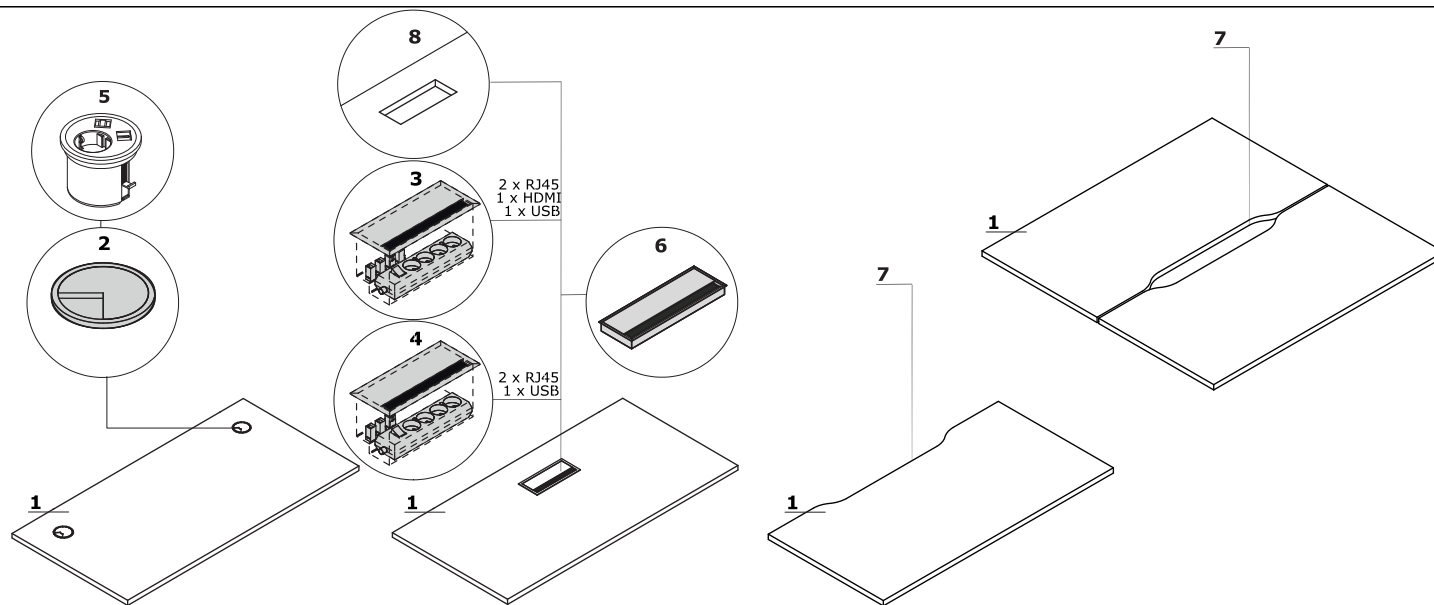

Stelaż

- 1 Ogi Drive z elektryczną regulacją wysokości** - w zakresie 650–1300 mm, metal malowany proszkowo, 3 nakładane profile 50x50 mm, 55x55 mm i 60x60 mm
2 Ogi Drive z elektryczną regulacją wysokości - w zakresie 700–1200 mm, metal malowany proszkowo, 2 nakładane profile 55x55 mm i 60x60 mm
3 Ogi Drive z manualną regulacją wysokości - metal malowany proszkowo, 2 nakładane profile 50 x 50 mm i 60 x 60 mm, regulacja w zakresie 650-1000 mm
4 OPCJA Z DOPLATĄ - stopa Yan T (150 zł/ kpl.):
 •malowane proszkowo
 •aluminium polerowane (dodatkowa dopłata 90 zł/ kpl.)

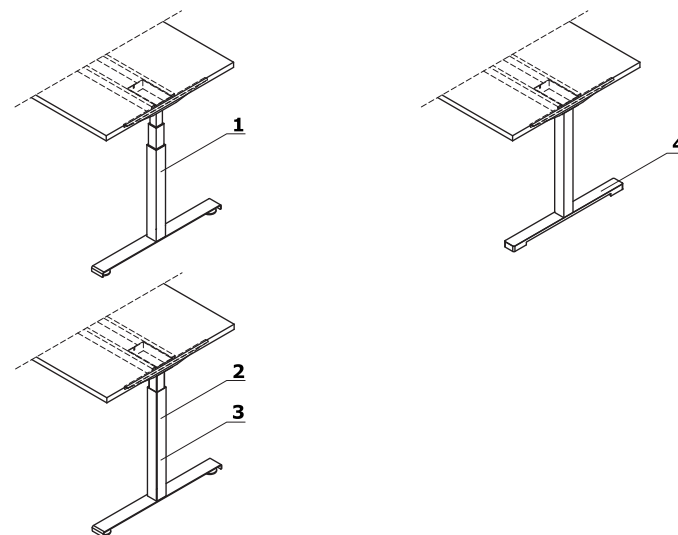

Stelaż elektryczny - Ogi Drive

- 1 **Blat** - płyta melaminowana 28 mm, obrzeża ABS
- 2 **Panele ZD** - klasa akustyczności "A", możliwość wpinania szpilek, zamek błyskawiczny, brak możliwości odpinania
- 3 **Mocowanie** - metal malowany proszkowo
- 4 **Łącznik metalowy**
- 5 **Stopki** - regulacja poziomu od wewnątrz w zakresie 5 mm
- 6 **Panel sterujący** - płynna regulacja wysokości:
 - A - podstawowy panel sterowania; czujność systemu antykolizyjnego ustawiona na poziomie Medium
 - B - OPCJA Z DOPŁATĄ - panel sterujący z pamięcią 4 wysokości; możliwość zmiany czułości systemu antykolizyjnego w obrębie 3 poziomów: Low, Medium, High
 - C - OPCJA Z DOPŁATĄ - moduł bluetooth:
 - kompatybilny zarówno z panelem A jak i z panelem B
 - możliwość zmiany czułości systemu antykolizyjnego w obrębie 3 poziomów: Low, Medium, High
 - sterowanie za pomocą aplikacji MDD Desk BT (do pobrania z Google Play lub App Store). Aplikacja posiada funkcję interwału czasowego, która informuje o konieczności zmiany położenia ciała (z siedzącej na stojącą lub ze stojącej na siedzącą)
- 7 **Stelaż elektryczny** - metal malowany proszkowo, udźwig 100 kg, kolumna teleskopowa.

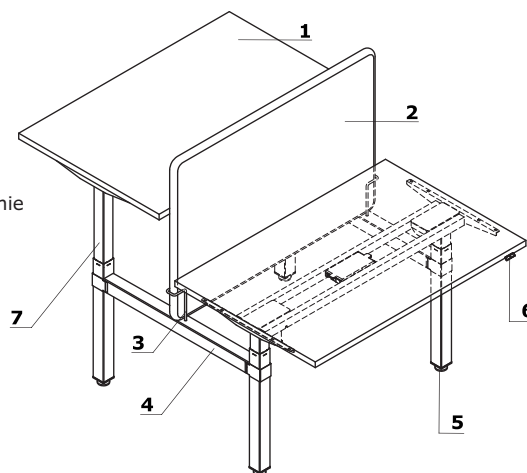

Specyfikacja techniczna stelaża

- Podnoszenie** - 40 mm/s Super Soft - Start - Stop
- Napęd** - 2 silniki z synchronizacją, sterowane przez mikroprocesor z zabezpieczeniem przed przeciążeniem, termiczny czujnik pracy silnika
- Poziom hałasu** - < 48dB
- Zabezpieczenie** - system antykolizyjny
- Normy** - EN 527-2
- Dyrektywy** - 206/95EC, UI508 1999, UL 1004 R7 06, WE DC 2004/108WE
- Zasilanie** - 230V, moc 300W, zużycie w trybie Stand - by 0.3W

A

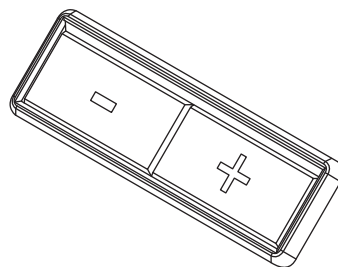

B

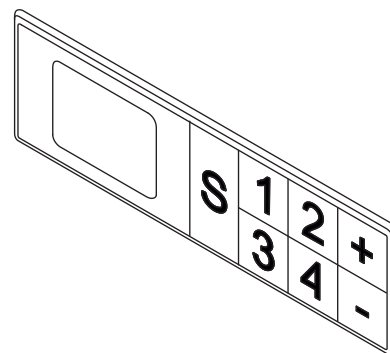

C

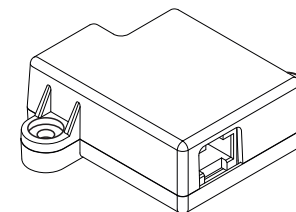

UWAGI - Odstęp między blatami w biurku typu bench 90 mm

Stelaż elektryczny ze wspólną szyną kablową - Ogi Drive

- 1 **Błat** - płyta melaminowana 28 mm, obrzeża ABS
- 2 **Stelaż elektryczny** - metal malowany proszkowo, udźwig 100 kg, kolumna teleskopowa.
- 3 **Wspólna szyna kablowa + kręgosłup do prowadzenia kabla**
- 4 **Łącznik metalowy**
- 5 **Stopki** - regulacja poziomu od wewnątrz w zakresie 5 mm
- 6 **Panel sterujący** - płynna regulacja wysokości:
 - A - podstawowy panel sterowania; czujność systemu antykolizyjnego ustawiona na poziomie Medium
 - B - OPCJA Z DOPŁATĄ - panel sterujący z pamięcią 4 wysokości; możliwość zmiany czułości systemu antykolizyjnego w obrębie 3 poziomów: Low, Medium, High
 - C - OPCJA Z DOPŁATĄ - moduł bluetooth - kompatybilny z panelem A i B - sterowanie za pomocą aplikacji MDD Desk BT (do pobrania z Google Play lub App Store). Aplikacja posiada funkcję interwału czasowego, która informuje o konieczności zmiany położenia ciała (z siedzącej na stojącą lub ze stojącej na siedzącą)

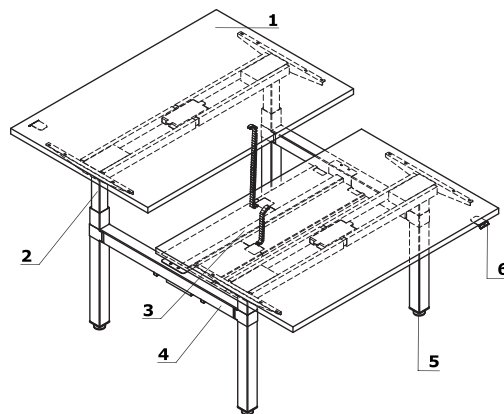

Usytuowanie mediaboxów

- A - Mediabox lewy
- B - Mediabox lewy/prawy
- C - Mediabox prawy

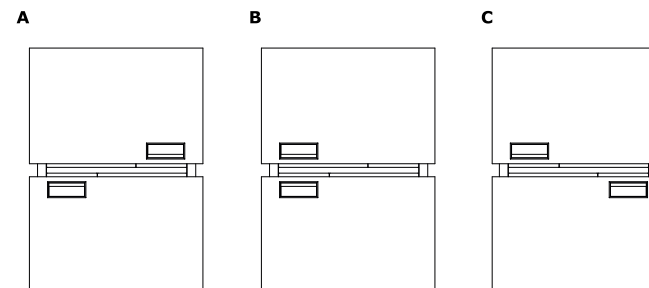

Stelaż na korbę - Ogi Drive

- 1 **Błat** - płyta melaminowana 28 mm, obrzeża ABS
- 2 **Panele ZD** - klasa akustyczności "A", możliwość wpinania szpilek, zamek błyskawiczny, brak możliwości odpinania
- 3 **Mocowanie** - metal malowany proszkowo
- 4 **Łącznik metalowy**
- 5 **Stopki** - regulacja poziomu od wewnątrz w zakresie 5 mm
- 6 **Korba** - uchwyt chowany, kolor: czarny, płynna regulacja w zakresie 650-1000 mm, obrót 2,25 mm, profile 60 x 60 mm, 50 x 50 mm

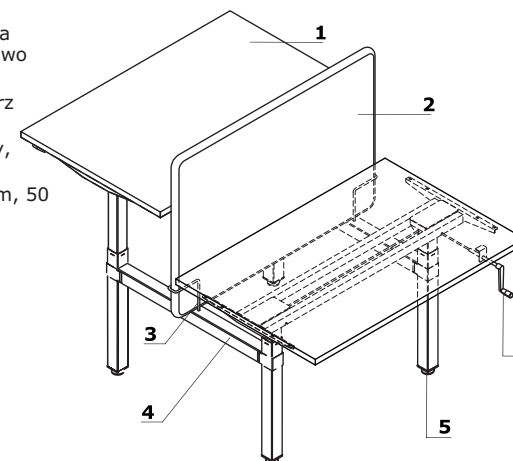

Biuorka proste z elektryczną regulacją wysokości w zakresie 700-1200 mm - sit-stand						
Symbol	Cena netto PLN	Wymiary			Waga Obj. Opak.	Uwagi
		Szer.	Gł.	Wys.		
BOD527	2480,-	1200	700	1200 700	42.1 kg 0.07 m3 4 szt.	
BOD547	2500,-	1400	700	1200 700	45.8 kg 0.076 m3 4 szt.	
BOD567	2530,-	1600	700	1200 700	49.3 kg 0.083 m3 4 szt.	
BOD587	2550,-	1800	700	1200 700	53.3 kg 0.089 m3 4 szt.	
BOD607	2570,-	2000	700	1200 700	57.3 kg 0.095 m3 4 szt.	
BOD52	2490,-	1200	800	1200 700	45.65 kg 0.074 m3 4 szt.	
BOD54	2520,-	1400	800	1200 700	50.5 kg 0.081 m3 4 szt.	
BOD56	2540,-	1600	800	1200 700	54.15 kg 0.088 m3 4 szt.	
BOD58	2560,-	1800	800	1200 700	58.45 kg 0.095 m3 4 szt.	
BOD60	2580,-	2000	800	1200 700	62.25 kg 0.102 m3 4 szt.	

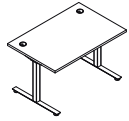

Dodatkowa dopłata									
Mediabox M04H	Mediabox M04	Top access	Panel sterujący z pamięcią 4 wysokości	Przepusty kablowe	Stopa YAN x2	Wycięcie kablowe	Moduł bluetooth	Wycięcie pod mediabox	
315,-	295,-	105,-	125,-	42,-	150,-	105,-	260,-	11,-	
315,-	295,-	105,-	125,-	42,-	150,-	105,-	260,-	11,-	
315,-	295,-	105,-	125,-	42,-	150,-	105,-	260,-	11,-	
315,-	295,-	105,-	125,-	42,-	150,-	105,-	260,-	11,-	
315,-	295,-	105,-	125,-	42,-	150,-	105,-	260,-	11,-	
315,-	295,-	105,-	125,-	42,-	150,-	105,-	260,-	11,-	
315,-	295,-	105,-	125,-	42,-	150,-	105,-	260,-	11,-	
315,-	295,-	105,-	125,-	42,-	150,-	105,-	260,-	11,-	
315,-	295,-	105,-	125,-	42,-	150,-	105,-	260,-	11,-	

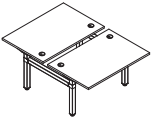
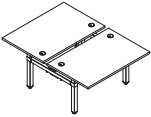
Biurka bench z elektryczną regulacją wysokości w zakresie 700-1200 mm - sit-stand							
	Symbol	Cena netto PLN	Wymiary			Waga Obj. Opak.	Uwagi
			Szer.	Gł.	Wys.		
	BOD572	4950,-	1200	1490	1200 700	83.2 kg 0.146 m3 8 szt.	
	BOD574	4990,-	1400	1490	1200 700	89.6 kg 0.157 m3 8 szt.	
	BOD576	5030,-	1600	1490	1200 700	95.6 kg 0.169 m3 8 szt.	
	BOD578	5080,-	1800	1490	1200 700	102.6 kg 0.181 m3 8 szt.	
	BOD570	5120,-	2000	1490	1200 700	109.6 kg 0.193 m3 8 szt.	
	BOD512	4970,-	1200	1690	1200 700	90.8 kg 0.155 m3 8 szt.	
	BOD514	5010,-	1400	1690	1200 700	99.5 kg 0.168 m3 8 szt.	
	BOD516	5060,-	1600	1690	1200 700	105.8 kg 0.181 m3 8 szt.	
	BOD518	5100,-	1800	1690	1200 700	113.4 kg 0.195 m3 8 szt.	
	BOD520	5150,-	2000	1690	1200 700	120 kg 0.208 m3 8 szt.	
Biurka bench ze wspólną szyną kablową z regulacją w zakresie 700-1200 mm - sit-stand							
	BOD712	6080,-	1200	1690	1200 700	97.8 kg 0.201 m3 9 szt.	biurka bench, w standardzie ze wspólną szyną kablową + kręgosłupem na kabłe
	BOD714	6120,-	1400	1690	1200 700	108 kg 0.223 m3 9 szt.	
	BOD716	6170,-	1600	1690	1200 700	115.8 kg 0.245 m3 9 szt.	
	BOD718	6210,-	1800	1690	1200 700	124.4 kg 0.267 m3 9 szt.	
	BOD720	6260,-	2000	1690	1200 700	133 kg 0.289 m3 9 szt.	

Dodatkowa dopłata									
Mediabox M04H	Mediabox M04	Top access	Panel sterujący z pamięcią 4 wysokości	Przepusty kablowe	Wycięcie kablowe	Moduł bluetooth	Wycięcie pod mediabox		
630,-	590,-	210,-	250,-	84,-	210,-	520,-	22,-		
630,-	590,-	210,-	250,-	84,-	210,-	520,-	22,-		
630,-	590,-	210,-	250,-	84,-	210,-	520,-	22,-		
630,-	590,-	210,-	250,-	84,-	210,-	520,-	22,-		
630,-	590,-	210,-	250,-	84,-	210,-	520,-	22,-		
630,-	590,-	210,-	250,-	84,-	210,-	520,-	22,-		
630,-	590,-	210,-	250,-	84,-	210,-	520,-	22,-		
630,-	590,-	210,-	250,-	84,-	210,-	520,-	22,-		
630,-	590,-	210,-	250,-	84,-	210,-	520,-	22,-		
630,-	590,-	210,-	250,-	84,-	210,-	520,-	22,-		
630,-	590,-	210,-	250,-	84,-	210,-	520,-	22,-		
630,-	590,-	210,-	250,-	84,-	210,-	520,-	22,-		
630,-	590,-	210,-	250,-	84,-	210,-	520,-	22,-		
630,-	590,-	210,-	250,-	84,-	210,-	520,-	22,-		
630,-	590,-	210,-	250,-	84,-	210,-	520,-	22,-		
630,-	590,-	210,-	250,-	84,-	210,-	520,-	22,-		
630,-	590,-	210,-	250,-	84,-	210,-	520,-	22,-		
630,-	590,-	210,-	250,-	84,-	210,-	520,-	22,-		
630,-	590,-	210,-	250,-	84,-	210,-	520,-	22,-		

Biuorka proste z elektryczną regulacją wysokości w zakresie 650-1300 mm - sit-stand						
Symbol	Cena netto PLN	Wymiary			Waga Obj. Opak.	Uwagi
		Szer.	Gł.	Wys.		
BOD627	2710,-	1200	700	1300 650	44.63 kg 0.063 m3 4 szt.	
BOD647	2730,-	1400	700	1300 650	48.33 kg 0.069 m3 4 szt.	
BOD667	2750,-	1600	700	1300 650	51.83 kg 0.076 m3 4 szt.	
BOD687	2770,-	1800	700	1300 650	55.83 kg 0.082 m3 4 szt.	
BOD707	2800,-	2000	700	1300 650	59.83 kg 0.088 m3 4 szt.	
BOD62	2720,-	1200	800	1300 650	48.18 kg 0.067 m3 4 szt.	
BOD64	2740,-	1400	800	1300 650	53.03 kg 0.074 m3 4 szt.	
BOD66	2760,-	1600	800	1300 650	56.68 kg 0.081 m3 4 szt.	
BOD68	2780,-	1800	800	1300 650	60.98 kg 0.088 m3 4 szt.	
BOD70	2810,-	2000	800	1300 650	64.78 kg 0.095 m3 4 szt.	

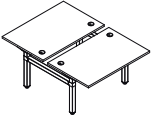
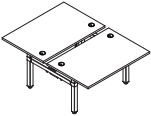

Dodatkowa dopłata									
Mediabox M04H	Mediabox M04	Top access	Panel sterujący z pamięcią 4 wysokości	Przepusty kablowe	Stopa YAN x2	Wycięcie kablowe	Moduł bluetooth	Wycięcie pod mediabox	
315,-	295,-	105,-	125,-	42,-	150,-	105,-	260,-	11,-	
315,-	295,-	105,-	125,-	42,-	150,-	105,-	260,-	11,-	
315,-	295,-	105,-	125,-	42,-	150,-	105,-	260,-	11,-	
315,-	295,-	105,-	125,-	42,-	150,-	105,-	260,-	11,-	
315,-	295,-	105,-	125,-	42,-	150,-	105,-	260,-	11,-	
315,-	295,-	105,-	125,-	42,-	150,-	105,-	260,-	11,-	
315,-	295,-	105,-	125,-	42,-	150,-	105,-	260,-	11,-	
315,-	295,-	105,-	125,-	42,-	150,-	105,-	260,-	11,-	
315,-	295,-	105,-	125,-	42,-	150,-	105,-	260,-	11,-	

Biurka bench z elektryczną regulacją wysokości w zakresie 650-1300 mm - sit-stand							
	Symbol	Cena netto PLN	Wymiary			Waga Obj. Opak.	Uwagi
			Szer.	Gł.	Wys.		
	BOD672	5390,-	1200	1490	1300 650	88.26 kg 0.132 m3 8 szt.	
	BOD674	5430,-	1400	1490	1300 650	94.66 kg 0.144 m3 8 szt.	
	BOD676	5480,-	1600	1490	1300 650	100.66 kg 0.155 m3 8 szt.	
	BOD678	5520,-	1800	1490	1300 650	107.66 kg 0.167 m3 8 szt.	
	BOD670	5570,-	2000	1490	1300 650	114.66 kg 0.179 m3 8 szt.	
	BOD612	5410,-	1200	1690	1300 650	95.86 kg 0.141 m3 8 szt.	
	BOD614	5450,-	1400	1690	1300 650	104.56 kg 0.154 m3 8 szt.	
	BOD616	5500,-	1600	1690	1300 650	110.86 kg 0.168 m3 8 szt.	
	BOD618	5540,-	1800	1690	1300 650	118.46 kg 0.181 m3 8 szt.	
	BOD620	5590,-	2000	1690	1300 650	125.06 kg 0.194 m3 8 szt.	
Biurka bench ze wspólną szyną kablową z regulacją w zakresie 700-1200 mm - sit-stand							
	BOD812	6530,-	1200	1690	1300 650	102.86 kg 0.187 m3 9 szt.	biurka bench, w standardzie ze wspólną szyną kablową + kręgosłupem na kabłe
	BOD814	6570,-	1400	1690	1300 650	113.06 kg 0.209 m3 9 szt.	
	BOD816	6620,-	1600	1690	1300 650	120.86 kg 0.231 m3 9 szt.	
	BOD818	6660,-	1800	1690	1300 650	129.46 kg 0.253 m3 9 szt.	
	BOD820	6700,-	2000	1690	1300 650	138.06 kg 0.275 m3 9 szt.	



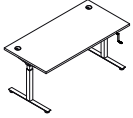
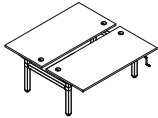

Dodatkowa dopłata									
Mediabox M04H	Mediabox M04	Top access	Panel sterujący z pamięcią 4 wysokości	Przepusty kablowe	Wycięcie kablowe	Moduł bluetooth	Wycięcie pod mediabox		
630,-	590,-	210,-	250,-	84,-	210,-	520,-	22,-		
630,-	590,-	210,-	250,-	84,-	210,-	520,-	22,-		
630,-	590,-	210,-	250,-	84,-	210,-	520,-	22,-		
630,-	590,-	210,-	250,-	84,-	210,-	520,-	22,-		
630,-	590,-	210,-	250,-	84,-	210,-	520,-	22,-		
630,-	590,-	210,-	250,-	84,-	210,-	520,-	22,-		
630,-	590,-	210,-	250,-	84,-	210,-	520,-	22,-		
630,-	590,-	210,-	250,-	84,-	210,-	520,-	22,-		
630,-	590,-	210,-	250,-	84,-	210,-	520,-	22,-		
630,-	590,-	210,-	250,-	84,-	210,-	520,-	22,-		
630,-	590,-	210,-	250,-	84,-	210,-	520,-	22,-		
630,-	590,-	210,-	250,-	84,-	210,-	520,-	22,-		
630,-	590,-	210,-	250,-	84,-	210,-	520,-	22,-		

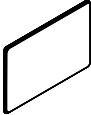
Biuurka proste z regulacją wysokości na korbę, w zakresie 650-1000 mm - sit-sit							
	Symbol	Cena netto PLN	Wymiary			Waga Obj. Opak.	Uwagi
			Szer.	Gł.	Wys.		
	BOC02	1740,-	1200	800	1000 650	45 kg 0.072 m3 4 szt.	
	BOC03	1770,-	1400	800	1000 650	47.9 kg 0.079 m3 4 szt.	
	BOC04	1810,-	1600	800	1000 650	52.5 kg 0.087 m3 4 szt.	
	BOC05	1840,-	1800	800	1000 650	55.4 kg 0.095 m3 4 szt.	
	BOC06	1880,-	2000	800	1000 650	72.15 kg 0.12 m3 5 szt.	
	Biuurka bench z regulacją wysokości na korbę w zakresie 650-1000 mm - sit-sit						
	BOC20	3480,-	1200	1690	1000 650	91.5 kg 0.155 m3 8 szt.	
	BOC30	3540,-	1400	1690	1000 650	96.8 kg 0.17 m3 8 szt.	
	BOC40	3610,-	1600	1690	1000 650	105.5 kg 0.186 m3 8 szt.	
	BOC50	3690,-	1800	1690	1000 650	110.8 kg 0.201 m3 8 szt.	
	BOC60	3750,-	2000	1690	1000 650	117.8 kg 0.216 m3 8 szt.	



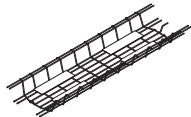
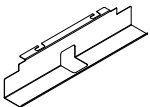

Dodatkowa dopłata									
Mediabox M04H	Mediabox M04	Top access	Przepusty kablowe	Stopa YAN x2	Wycięcie kablowe	Wycięcie pod mediabox			
315,-	295,-	105,-	42,-	150,-	105,-	11,-			
315,-	295,-	105,-	42,-	150,-	105,-	11,-			
315,-	295,-	105,-	42,-	150,-	105,-	11,-			
315,-	295,-	105,-	42,-	150,-	105,-	11,-			
315,-	295,-	105,-	42,-	150,-	105,-	11,-			
630,-	590,-	210,-	84,-		210,-	22,-			
630,-	590,-	210,-	84,-		210,-	22,-			
630,-	590,-	210,-	84,-		210,-	22,-			
630,-	590,-	210,-	84,-		210,-	22,-			
630,-	590,-	210,-	84,-		210,-	22,-			

Sonic - panele akustyczne do biurek typu bench							
	Symbol	Cena netto PLN	Wymiary			Waga Obj. Opak.	Uwagi
			Szer.	Gł.	Wys.		
	ZD812	845,-	1190	40	800	13.6 kg 0.056 m3 2 szt.	do benchy o szer. 1200mm
	ZD814	920,-	1390	40	800	8.6 kg 0.064 m3 2 szt.	do benchy o szer. 1400mm
	ZD816	985,-	1590	40	800	7.4 kg 0.066 m3 1 szt.	do benchy o szer. 1600mm
	ZD818	1055,-	1790	40	800	8.9 kg 0.08 m3 2 szt.	do benchy o szer. 1800mm
	ZD820	1125,-	1990	40	800	9.1 kg 0.08 m3 2 szt.	do benchy o szer. 2000mm



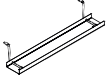
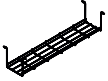
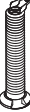

Dodatkowa dopłata									
II grupa cenowa	III grupa cenowa	IV grupa cenowa							
240,-	570,-	810,-							
280,-	660,-	940,-							
320,-	750,-	1050,-							
350,-	840,-	1200,-							
390,-	940,-	1350,-							

Akcesoria							
	Symbol	Cena netto PLN	Wymiary			Waga Obj. Opak.	Uwagi
			Szer.	Gł.	Wys.		
	SOD12	305,-	1200	290	77	2 kg 0.024 m3 1 szt.	pasuje do biurek BOD512, BOD612, BOC30
	SOD14	320,-	1400	290	77	2.5 kg 0.028 m3 1 szt.	pasuje do biurek BOD514, BOD614, BOC40
	SOD16	335,-	1600	290	77	3 kg 0.032 m3 1 szt.	pasuje do biurek BOD516, BOD616, BOC50
	SOD18	350,-	1800	290	77	3.5 kg 0.037 m3 1 szt.	pasuje do biurek BOD518, BOD618, BOC60
	SOD20	365,-	2000	290	77	4 kg 0.041 m3 1 szt.	pasuje do biurek BOD520, BOD620
		SG12	155,-	660	107	120	2 kg 0.018 m3 1 szt.
SG16		180,-	1160	107	120	3 kg 0.025 m3 1 szt.	do biurek pojedynczych o szerokości 1600 mm i 1800 mm
	PK80	34,-	80	80	23	0.1 kg 0 m3 1 szt.	przełot kablowy Ø 80 mm, 02 - szary, 08 - czarny, 67 - biały
	M07	505,-	80	80	80	1 kg 0.001 m3 1 szt.	mediabox, kolor: czarny, biały, montowany zamiast istniejącego przepustu kablowego Ø80mm (PK80); 1 gniazdo zasilające 230V + 1 x USB charger + 1 x RJ45
	M04	295,-	275	120	140	1.6 kg 0.008 m3 1 szt.	4x230V, 2xRJ45, 1xUSB
	M04H	315,-	275	120	140	2 kg 0.013 m3 2 szt.	4x230V, 2xRJ45, 1xUSB, 1xHDMI
	M05	105,-	275	120	25	0.3 kg 0.002 m3 1 szt.	top access

Dodatkowa dopłata							

Akcesoria							
	Symbol	Cena netto PLN	Wymiary			Waga Obj. Opak.	Uwagi
			Szer.	Gł.	Wys.		
	E64	115,-	460	89	120	0.5 kg 0.001 m3 1 szt.	kanał kablowy, M009 - aluminium półmat
	S69	130,-	580	162	123	1 kg 0.015 m3 1 szt.	09 - aluminium
	S94	249,-	140	140	750	0.95 kg 0.004 m3 1 szt.	przewodzenie kabli (sprężyna), 09 - aluminium
	S93	105,-	470	62	34	1 kg 0.002 m3 1 szt.	pionowy organizer kablowy, pasuje do biurki Ogi Drive, Yan, Ogi A, Ogi Q i Ogi U o profilu 60 mm
	S81	155,-	140	70	750	1.1 kg 0.008 m3 1 szt.	przewodzenie kabli (kręgosłup); kolor 09 - aluminium, do biurki bez regulacji wysokości
	S96	80,-	1370	28	2	0.3 kg 0.003 m3 1 szt.	tkaninowy organizer kablowy, pasuje do biurki Ogi, Ogi Drive
	S82	80,-	1000	70	35	1 kg 0.005 m3 1 szt.	grzebień do mocowania kabli pod blatem, 09 - aluminium

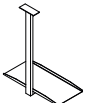
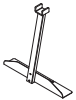
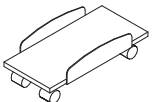
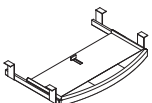
Dodatkowa dopłata							

Akcesoria							
	Symbol	Cena netto PLN	Wymiary			Waga Obj. Opak.	Uwagi
			Szer.	Gł.	Wys.		
	AK3	39,-	0	0	0	0.2 kg 0 m3 1 szt.	rzepy do mocowania kabli, 02-szary, 6 szt. (3 z wkrętami, 3 bez wkrętów);
	AK5	46,-	0	0	0	0.2 kg 0 m3 1 szt.	zaczep do prowadzenia kabla, 08 - czarny, 5 szt.
	S83	225,-	212	460	605	2.596 kg 0.027 m3 1 szt.	zawieszanie do komputera
	S89	275,-	116	460	549	3.5 kg 0.005 m3 1 szt.	pasuje do biurka Ogi Drive, Ogi W, Ogi M, Ogi Q, Ogi U oraz Ogi Y, z wyjątkiem Ogi A, Ogi N, Ogi V
	S73	179,-	220	470	148	2.9 kg 0.002 m3 1 szt.	wózek do komputera, 26 - aluminium satinato
	C01	149,-	610	400	85	1.3 kg 0.01 m3 1 szt.	półka pod klawiaturę do biurka o głębokości 800 mm, z wyjątkiem biurka Drive, 02 - szary
	S11	65,-	45	50	57	0.2 kg 0 m3 1 szt.	wieszak na torebkę, M015 - biały półmat

Dodatkowa dopłata							

Zestawienie kolorystyczne - Ogi

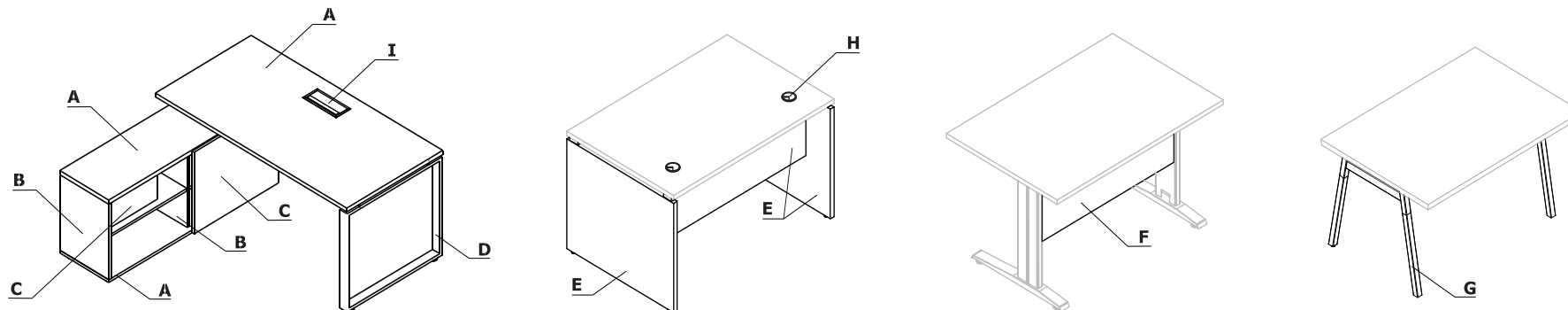

Materiał	Kolor	Biuurka								Akcesoria					
		A - Blat, wieniec górny i dolny	B - Korpus	C - Front	D - Stelaż	E - Podstawa Ogi V	F - Osłona płytowa Ogi N	G - Podstawa Ogi W	H - Przepusty kablowe	I - Mediabox	SOD12-SOD20, SG12, SG16, SG220, SG260	E64, S69	S94, S95, S81, S82	S83, S89, S93	S11
Płyta	26 - aluminium satinato	✓**	✓	✓		✓			Aluminium						
	31 - dąb kanadyjski	✓	II grupa	✓					Beżowy						
	39 - brzoza polarna	✓	II grupa	✓					Beżowy						
	64 - kakao	✓	II grupa	✓					Beżowy						
	67 - biały pastel	✓**	✓	✓		✓			Biały						
	106 - orzech nizinny	✓	II grupa	✓					Czarny						
	154 - antracyt	✓**	✓	✓		✓			Czarny						
	08 - czarny	✓**	✓	✓		✓			Czarny						
	167 - dąb szary	✓	II grupa	✓					Czarny						
	168 - dąb naturalny	✓	II grupa	✓					Beżowy						
	169 - dąb miodowy	✓	II grupa	✓					Beżowy						
	170 - akacja	✓	II grupa	✓					Beżowy						
171 - orzech ciemny	✓	II grupa	✓					Czarny							
Metal	M009 - aluminium półmat RAL 9006				✓			26 - aluminium satinato		✓		✓		✓	
	M015 - biały półmat RAL 9010				✓			67 - biały pastel		✓				✓	✓
	M154 - antracyt półmat RAL 7043				✓			154 - antracyt		✓				✓	✓
	M115 - czarny półmat RAL 9005				✓			08 - czarny		✓				✓	
	25 - aluminium polerowane									✓				✓	

* stopa - dopłata 92 zł za 1 szt., do ceny biurka 184zł (komplet 2szt.)

*** kolorystyka poszczególnych nóg biurka może różnić się w zależności od naturalnego rysunku stajów drewna.

Materiał	Kolor	Biorka									Akcesoria				
	A - Biał, wieniec górny i dolny	B - Korpus	C - Front	D - Stelaż	E - Podstawa Ogi V	F - Osłona płytowa Ogi N	G - Podstawa Ogi W	H - Przepusty kablowe	I - Mediabox	SOD12-SOD20, SG12, SG16, SG220, SG260	E64, S69	S94, S95, S81, S82	S83, S89, S93	S11	
Tworzywo	Tworzywo - szary										✓				
	Jesion naturalny						✓***								

Błaty biurek Ogi

1 Blat - płyta melaminowana 28 mm, obrzeża ABS

OPCJE Z DOPLATĄ:

- 2 Przepust kablowy** - 2 szt., Ø 80 mm
3 Mediabox M04H - 2xRJ45 (class E, cat. 6); + 1 x USB + 1 x HDMI + 4 x 230V, kolor mediaboxu dobiera się do kolorystyki stelaża
4 Mediabox M04 - 2xRJ45 (class E, cat. 6); + 1 x USB + 4 x 230V, kolor mediaboxu dobiera się do kolorystyki stelaża
5 Mediabox M07 - 1 x 230V + 1 x USB charger + 1 x RJ45, kolor: czarny, biały, montowany zamiast istniejącego przepustu kablowego Ø80 mm (PK80)
6 Top access M05 - kolor top access dobiera się do kolorystyki stelaża
7 Wycięcie kablowe - szerokość otworu jest proporcjonalna do szerokości blatu
8 Wycięcie pod mediabox - mediabox wybierany osobno

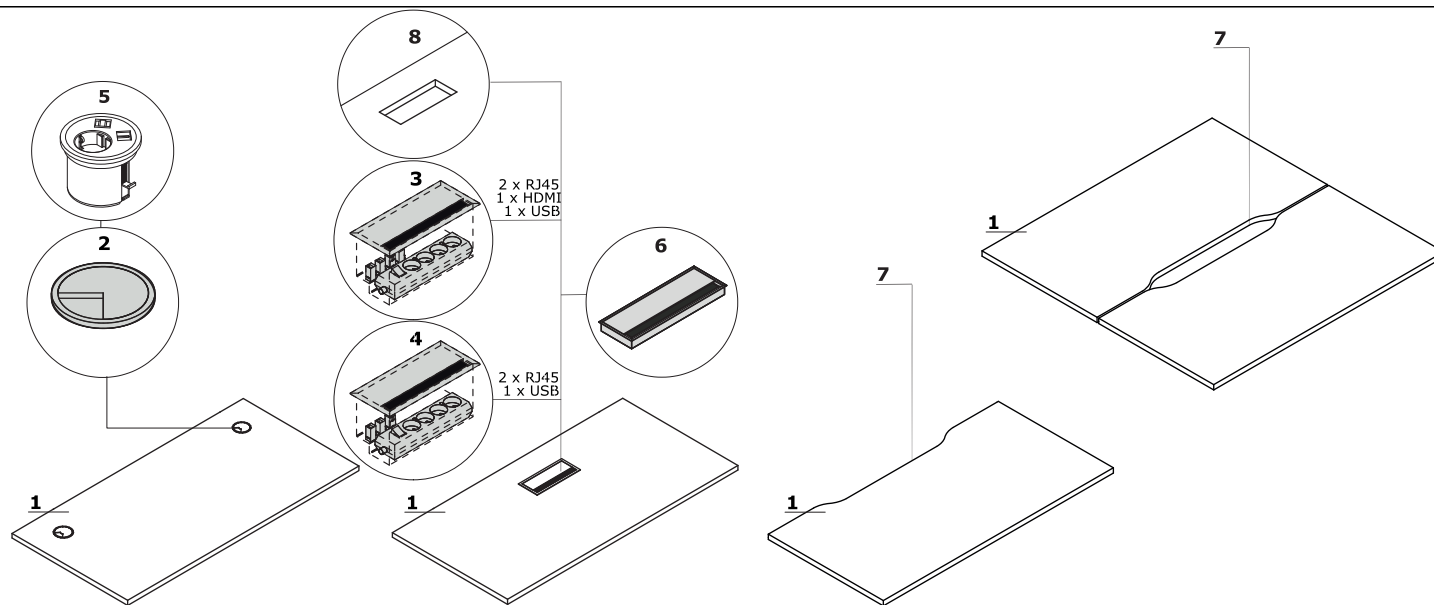

Wymiary blatów kształtowych (mm)

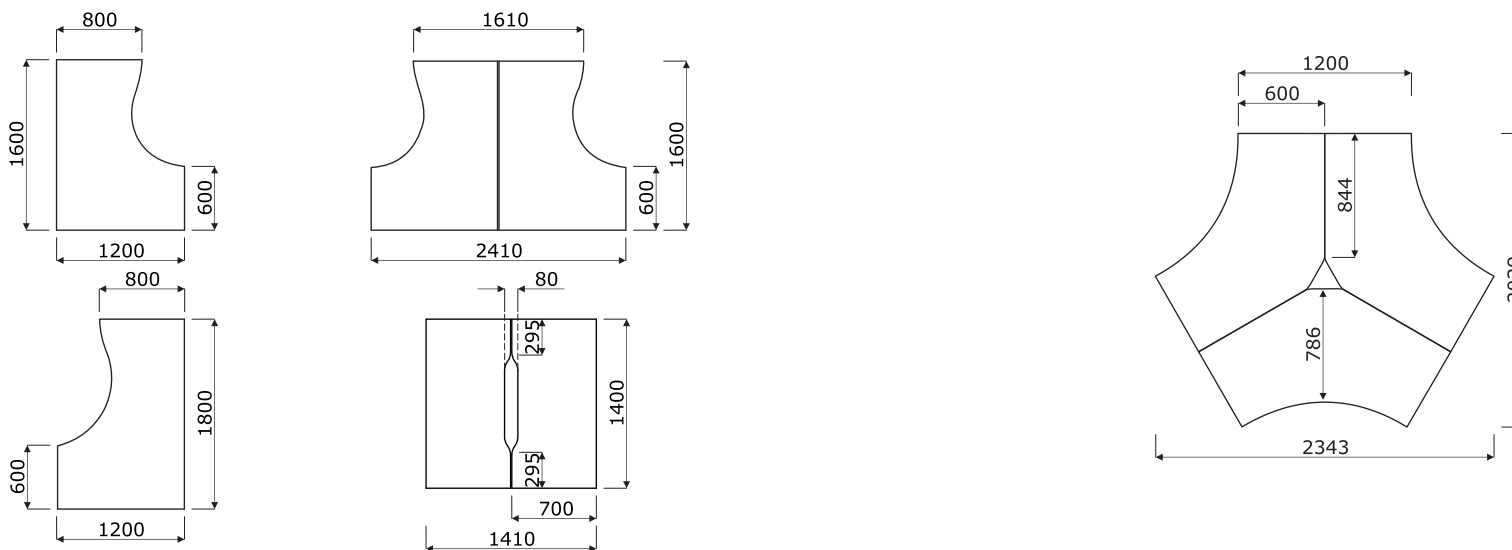

Stelaż

- **Ogi W** - noga drewniana, kolor: jesion naturalny, pokryta bezbarwnym lakierem, profil 40 × 40 mm z elementem metalowym malowanym proszkowo, między blatem, a stelażem dystans 10 mm
- **Ogi M** - metal malowany proszkowo, profil 40x40 mm, między blatem, a stelażem dystans 10 mm
- **Ogi A** - metal malowany proszkowo, profil 60x30 mm
- **Ogi Q** - metal malowany proszkowo, profil 60x20 mm, między blatem a stelażem dystans 10 mm
- **Ogi N** - metal malowany proszkowo, kolumna 642x149x36 mm, stopa 647x60 mm, pionowe prowadzenie okablowania, łączyna - płyta melaminowana 18 mm
- **Ogi U** - metal malowany proszkowo, profil 60x30 mm, między blatem a stelażem dystans 10 mm
- **Ogi Y** - metal malowany proszkowo, profil 40x40 mm, między blatem a stelażem dystans 10 mm
- **Ogi Y z regulacją wysokości *** - metal malowany proszkowo, 2 nakładane profile 30x30 i 40x40 mm, regulacja w zakresie 640 - 860 mm, skokowo co 20 mm
- **Ogi V** - nogi - płyta 28 mm, łączyna - płyta 18 mm, między blatem a nogą dystans aluminiowy 60x20 mm



Ogi W

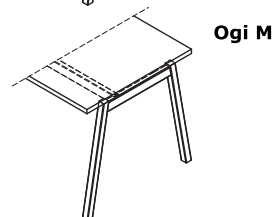

Ogi M

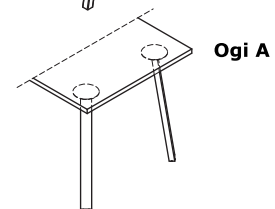

Ogi A

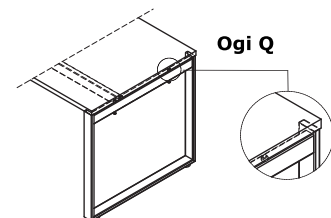

Ogi Q

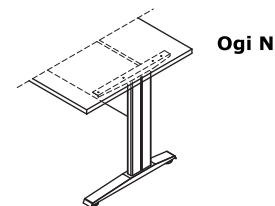

Ogi N

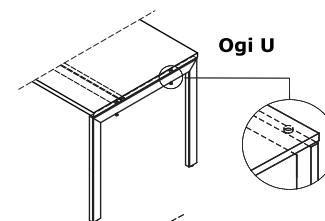

Ogi U

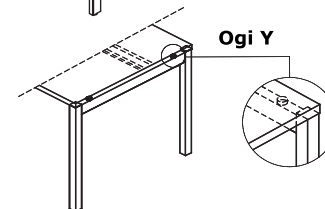

Ogi Y

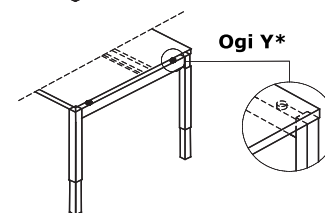

Ogi Y*

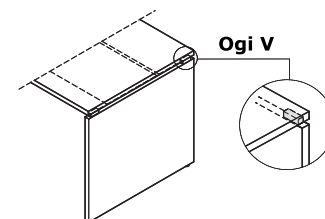

Ogi V

Uwaga - regulatory poziomu - regulacja w zakresie 10 mm

Uwaga - Szyna pod blatem zawsze w kolorze: M009 - aluminium półmat

Biurko z szafką managerską

- 1 Blat** - płyta melaminowana 28 mm, obrzeża ABS
- 2 Wieniec górny** - płyta melaminowana 28 mm, obrzeża ABS
- 3 Półka** - płyta melaminowana 18 mm, zabezpieczenie przed przypadkowym wysunięciem, obrzeże ABS
- 4 Szuflada** - płyta melaminowana 18 mm, obrzeża ABS, zamek patentowy - możliwość zmiany usytuowania
- 5 Wieniec dolny** - płyta melaminowana 18 mm, obrzeża ABS
- 6 Front** - płyta melaminowana 18 mm, obrzeża ABS

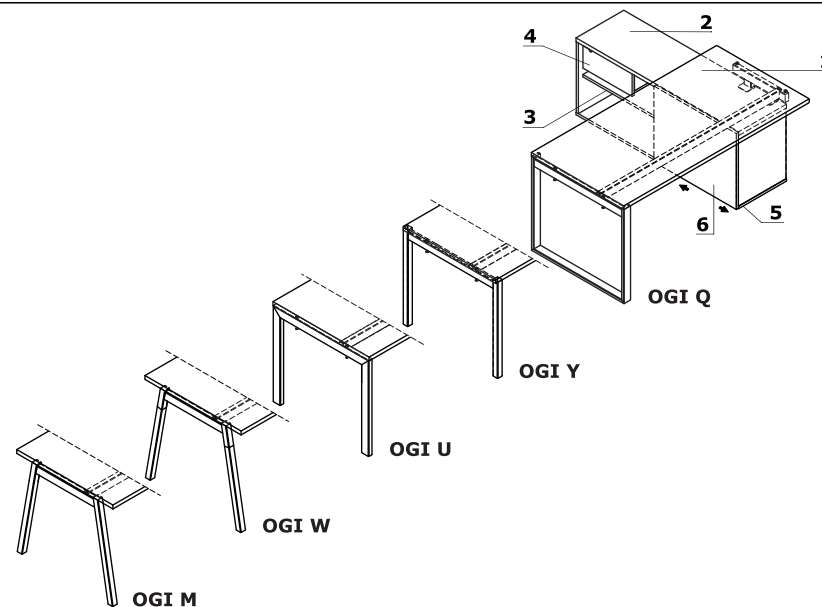

Przykładowe konfiguracje (mm)

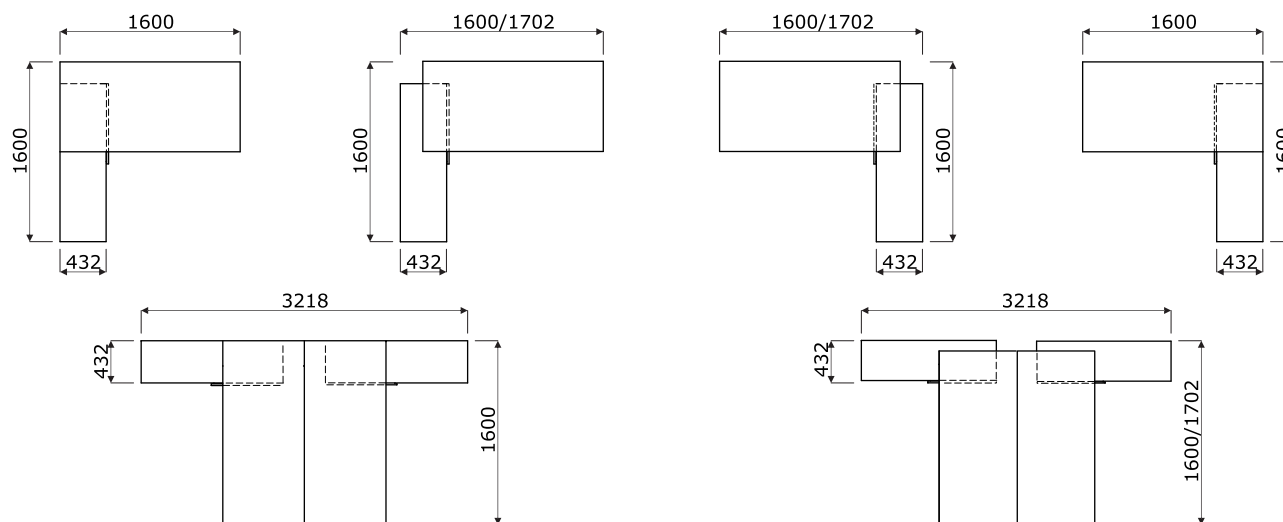

Przystawki do biurk

- **PLQ01** - przystawka z nogą Ogi Q
- **PLY01** - przystawka z nogą Ogi Y
- **PLU01** - przystawka z nogą Ogi U

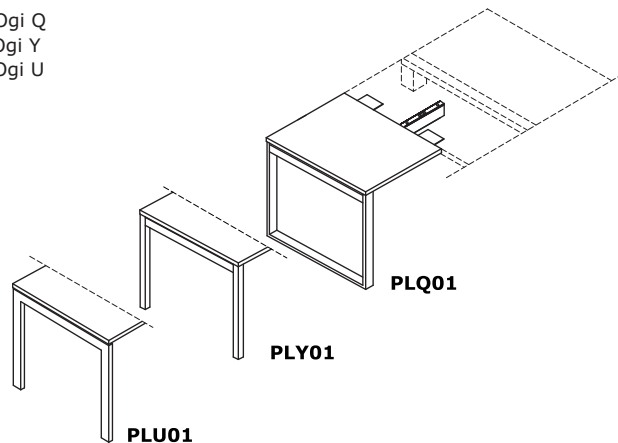

Akcesoria

- 1 Szyna S69** - metal malowany proszkowo, kolor: 09-aluminium
- 2 Szyna do pojedynczego biurka (SG12, SG16)** - metal malowany proszkowo, kolor: M009 - aluminium półmat
- 3 Szyna E64** - metal malowany proszkowo, kolor: M009 - aluminium półmat
- 4 Szyna do bench Ogi Drive (SOD12, SOD14, SOD16, SOD18, SOD20)** - metal malowany proszkowo, kolor: M009 - aluminium półmat
- 5 Szyna do biurk typu bench (SG220, SG260)** - drut stalowy $\varnothing 4$ mm, malowany proszkowo, kolor: 09 - aluminium

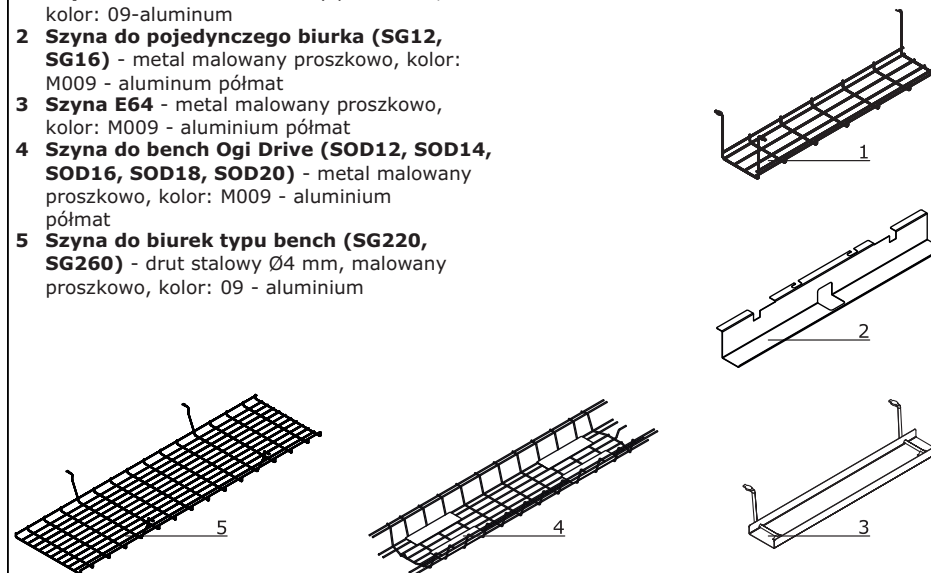

Przykładowe konfiguracje z wykorzystaniem BOX40, BOX50, BOX60

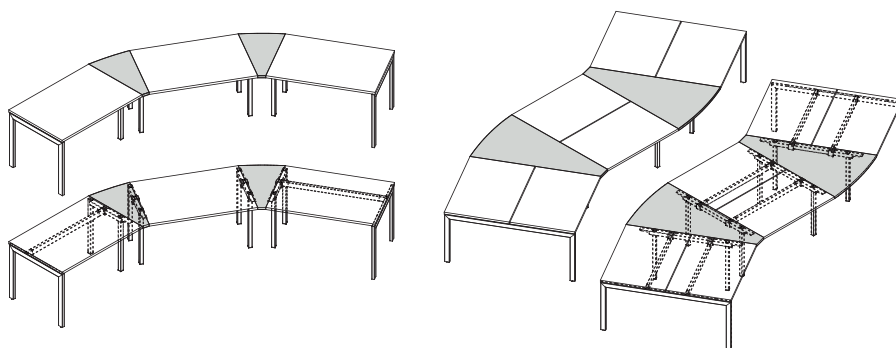

UWAGI - Wyłącznie do systemów Ogi Q, Ogi U, Ogi Y, Ogi M

Biuorka proste						
Symbol	Cena netto PLN	Wymiary			Waga Obj. Opak.	Uwagi
		Szer.	Gł.	Wys.		
BOM10	680,-	1000	600	740	24.3 kg 0.064 m3 3 szt.	tworzenie układów, patrz: Ogi M, Ogi Q, Ogi U, Ogi Y - elementy do rozbudowy
BOM12	700,-	1200	600	740	26.3 kg 0.069 m3 3 szt.	
BOM14	720,-	1400	600	740	29 kg 0.074 m3 3 szt.	
BOM16	745,-	1600	600	740	32.5 kg 0.079 m3 3 szt.	
BOM19	695,-	1000	700	740	24.3 kg 0.075 m3 3 szt.	
BOM22	715,-	1200	700	740	32 kg 0.084 m3 3 szt.	
BOM24	730,-	1400	700	740	33.6 kg 0.091 m3 3 szt.	
BOM26	755,-	1600	700	740	37.15 kg 0.097 m3 3 szt.	
BOM02	725,-	1200	800	740	35 kg 0.096 m3 3 szt.	
BOM03	745,-	1400	800	740	37.5 kg 0.103 m3 3 szt.	
BOM04	765,-	1600	800	740	42.55 kg 0.11 m3 3 szt.	
BOM05	845,-	1800	800	740	46.55 kg 0.116 m3 3 szt.	
BOM06	875,-	2000	800	740	47.95 kg 0.124 m3 5 szt.	

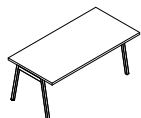

Dodatkowa dopłata							
Mediabox M04H	Mediabox M04	Top access	Przepusty kablowe	Wycięcie kablowe	Wycięcie pod mediabox		
315,-	295,-	105,-	42,-	105,-	11,-		
315,-	295,-	105,-	42,-	105,-	11,-		
315,-	295,-	105,-	42,-	105,-	11,-		
315,-	295,-	105,-	42,-	105,-	11,-		
315,-	295,-	105,-	42,-	105,-	11,-		
315,-	295,-	105,-	42,-	105,-	11,-		
315,-	295,-	105,-	42,-	105,-	11,-		
315,-	295,-	105,-	42,-	105,-	11,-		
315,-	295,-	105,-	42,-	105,-	11,-		
315,-	295,-	105,-	42,-	105,-	11,-		
315,-	295,-	105,-	42,-	105,-	11,-		
315,-	295,-	105,-	42,-	105,-	11,-		

Biuorka typu bench							
Symbol	Cena netto PLN	Wymiary			Waga Obj. Opak.	Uwagi	
		Szer.	Gł.	Wys.			
BOM50	1010,-	1000	1210	740	42.6 kg 0.129 m3 5 szt.	tworzenie układów, patrz: Ogi M, Ogi Q, Ogi U, Ogi Y - elementy do rozbudowy	
BOM52	1050,-	1200	1210	740	46.6 kg 0.138 m3 5 szt.		
BOM54	1090,-	1400	1210	740	52 kg 0.148 m3 5 szt.		
BOM56	1160,-	1600	1210	740	59 kg 0.157 m3 5 szt.		
BOM48	1040,-	1000	1410	740	43.6 kg 0.149 m3 5 szt.		
BOM42	1080,-	1200	1410	740	59 kg 0.168 m3 5 szt.		
BOM44	1120,-	1400	1410	740	62.2 kg 0.181 m3 5 szt.		
BOM46	1180,-	1600	1410	740	69.3 kg 0.193 m3 5 szt.		
BOM32	1110,-	1200	1610	740	64 kg 0.191 m3 5 szt.		
BOM33	1140,-	1400	1610	740	69 kg 0.206 m3 5 szt.		
BOM34	1200,-	1600	1610	740	79.1 kg 0.22 m3 5 szt.		
BOM35	1360,-	1800	1610	740	87.1 kg 0.233 m3 5 szt.		

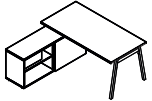
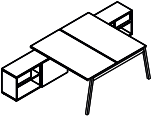
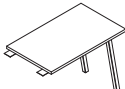

Dodatkowa dopłata							
Mediabox M04H	Mediabox M04	Top access	Przepusty kablowe	Wycięcie kablowe	Wycięcie pod mediabox		
630,-	590,-	210,-	84,-	210,-	22,-		
630,-	590,-	210,-	84,-	210,-	22,-		
630,-	590,-	210,-	84,-	210,-	22,-		
630,-	590,-	210,-	84,-	210,-	22,-		
630,-	590,-	210,-	84,-	210,-	22,-		
630,-	590,-	210,-	84,-	210,-	22,-		
630,-	590,-	210,-	84,-	210,-	22,-		
630,-	590,-	210,-	84,-	210,-	22,-		
630,-	590,-	210,-	84,-	210,-	22,-		
630,-	590,-	210,-	84,-	210,-	22,-		
630,-	590,-	210,-	84,-	210,-	22,-		

Biuorka z szafką managerską							
	Symbol	Cena netto PLN	Wymiary			Waga Obj. Opak.	Uwagi
			Szer.	Gł.	Wys.		
	BOM20	1880,-	1702 1600	1600	740	103.25 kg 0.239 m3 9 szt.	uniwersalne (lewe / prawe)
	BOM21	1960,-	1902 1800	1600	740	105.65 kg 0.238 m3 8 szt.	
	BOM40	3540,-	1702 1600	3210	740	200.3 kg 0.489 m3 15 szt.	
	BOM41	3710,-	1902 1800	3210	740	208.3 kg 0.502 m3 15 szt.	
Przystawki do biurerek							
	POM01	560,-	600	800	740	15.65 kg 0.024 m3 5 szt.	
	POM02	585,-	600	1000	740	16.65 kg 0.029 m3 5 szt.	
	POM03	605,-	600	1200	740	18.65 kg 0.034 m3 5 szt.	

Dodatkowa dopłata							
Mediabox M04H	Mediabox M04	Top access	II grupa cenowa	Przepusty kablowe	Wycięcie kablowe	Wycięcie pod mediabox	
315,-	295,-	105,-	80,-	42,-	105,-	11,-	
315,-	295,-	105,-	80,-	42,-	105,-	11,-	
630,-	590,-	210,-	160,-	84,-	210,-	22,-	
630,-	590,-	210,-	160,-	84,-	210,-	22,-	

Biuorka proste							
Symbol	Cena netto PLN	Wymiary			Waga Obj. Opak.	Uwagi	
		Szer.	Gł.	Wys.			
BOQ10	760,-	1000	600	740	28.9 kg 0.085 m3 4 szt.	tworzenie układów, patrz: elementy do rozbudowy - Ogi M, Ogi Q, Ogi U, Ogi Y	
BOQ12	785,-	1200	600	740	32.6 kg 0.094 m3 4 szt.		
BOQ14	810,-	1400	600	740	35.1 kg 0.099 m3 4 szt.		
BOQ16	835,-	1600	600	740	38.4 kg 0.105 m3 4 szt.		
BOQ20	770,-	1000	700	740	29.96 kg 0.094 m3 3 szt.		
BOQ22	800,-	1200	700	740	37.66 kg 0.104 m3 3 szt.		
BOQ24	820,-	1400	700	740	39.26 kg 0.11 m3 3 szt.		
BOQ26	845,-	1600	700	740	42.81 kg 0.116 m3 3 szt.		
BOQ02	810,-	1200	800	740	40.85 kg 0.118 m3 3 szt.		
BOQ03	835,-	1400	800	740	43.35 kg 0.125 m3 3 szt.		
BOQ04	860,-	1600	800	740	48.4 kg 0.132 m3 3 szt.		
BOQ05	950,-	1800	800	740	52.4 kg 0.138 m3 3 szt.		
BOQ06	1010,-	2000	800	740	52.4 kg 0.145 m3 3 szt.		

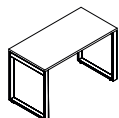

Dodatkowa dopłata							
Mediabox M04H	Mediabox M04	Top access	Przepusty kablowe	Wycięcie kablowe	Wycięcie pod mediabox		
315,-	295,-	105,-	42,-	105,-	11,-		
315,-	295,-	105,-	42,-	105,-	11,-		
315,-	295,-	105,-	42,-	105,-	11,-		
315,-	295,-	105,-	42,-	105,-	11,-		
315,-	295,-	105,-	42,-	105,-	11,-		
315,-	295,-	105,-	42,-	105,-	11,-		
315,-	295,-	105,-	42,-	105,-	11,-		
315,-	295,-	105,-	42,-	105,-	11,-		
315,-	295,-	105,-	42,-	105,-	11,-		
315,-	295,-	105,-	42,-	105,-	11,-		
315,-	295,-	105,-	42,-	105,-	11,-		
315,-	295,-	105,-	42,-	105,-	11,-		
315,-	295,-	105,-	42,-	105,-	11,-		

Biuorka typu bench							
Symbol	Cena netto PLN	Wymiary			Waga Obj. Opak.	Uwagi	
		Szer.	Gł.	Wys.			
BOQ50	1220,-	1000	1210	740	50.6 kg 0.164 m3 5 szt.	tworzenie układów, patrz: Ogi M, Ogi Q, Ogi U, Ogi Y - elementy do rozbudowy	
BOQ52	1270,-	1200	1210	740	54.6 kg 0.174 m3 5 szt.		
BOQ54	1310,-	1400	1210	740	60 kg 0.184 m3 5 szt.		
BOQ56	1360,-	1600	1210	740	67 kg 0.193 m3 5 szt.		
BOQ40	1250,-	1000	1410	740	40.72 kg 0.188 m3 5 szt.		
BOQ42	1290,-	1200	1410	740	56.12 kg 0.208 m3 5 szt.		
BOQ44	1340,-	1400	1410	740	59.32 kg 0.221 m3 5 szt.		
BOQ46	1390,-	1600	1410	740	66.42 kg 0.233 m3 5 szt.		
BOQ32	1310,-	1200	1610	740	60 kg 0.236 m3 5 szt.		
BOQ33	1360,-	1400	1610	740	65 kg 0.25 m3 5 szt.		
BOQ34	1410,-	1600	1610	740	75.1 kg 0.264 m3 5 szt.		
BOQ35	1470,-	1800	1610	740	83.1 kg 0.278 m3 5 szt.		

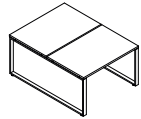

Dodatkowa dopłata							
Mediabox M04H	Mediabox M04	Top access	Przepusty kablowe	Wycięcie kablowe	Wycięcie pod mediabox		
630,-	590,-	210,-	84,-	210,-	22,-		
630,-	590,-	210,-	84,-	210,-	22,-		
630,-	590,-	210,-	84,-	210,-	22,-		
630,-	590,-	210,-	84,-	210,-	22,-		
630,-	590,-	210,-	84,-	210,-	22,-		
630,-	590,-	210,-	84,-	210,-	22,-		
630,-	590,-	210,-	84,-	210,-	22,-		
630,-	590,-	210,-	84,-	210,-	22,-		
630,-	590,-	210,-	84,-	210,-	22,-		
630,-	590,-	210,-	84,-	210,-	22,-		
630,-	590,-	210,-	84,-	210,-	22,-		

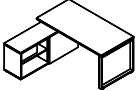
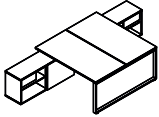
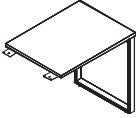

Bierka z szafką managerską							
	Symbol	Cena netto PLN	Wymiary			Waga Obj. Opak.	Uwagi
			Szer.	Gł.	Wys.		
	BOQL20	2270,-	1702 1600	1600	740	104.65 kg 0.25 m3 8 szt.	uniwersalne (lewe / prawe);
	BOQL21	2290,-	1902 1800	1600	740	108.65 kg 0.256 m3 8 szt.	
	BOQL40	4510,-	1702 1600	3210	740	206.3 kg 0.5 m3 15 szt.	
	BOQL41	4550,-	1902 1800	3210	740	214.3 kg 0.513 m3 15 szt.	
Przystawki do biurka							
	PLQ01	615,-	600	800	740	18.9 kg 0.051 m3 5 szt.	
	PLQ02	665,-	600	1000	740	20.9 kg 0.056 m3 5 szt.	
	PLQ03	700,-	600	1200	740	23.1 kg 0.061 m3 5 szt.	

Dodatkowa dopłata							
Mediabox M04H	Mediabox M04	Top access	II grupa cenowa	Przepusty kablowe	Wycięcie kablowe	Wycięcie pod mediabox	
315,-	295,-	105,-	80,-	42,-	105,-	11,-	
315,-	295,-	105,-	80,-	42,-	105,-	11,-	
630,-	590,-	210,-	160,-	84,-	210,-	22,-	
630,-	590,-	210,-	160,-	84,-	210,-	22,-	

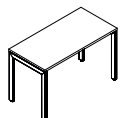
Biuorka proste						
Symbol	Cena netto PLN	Wymiary			Waga Obj. Opak.	Uwagi
		Szer.	Gł.	Wys.		
BOU10	640,-	1000	600	740	26.7 kg 0.059 m3 4 szt.	tworzenie układów, patrz: elementy do rozbudowy - Ogi M, Ogi Q, Ogi U, Ogi Y
BOU12	665,-	1200	600	740	30.4 kg 0.068 m3 4 szt.	
BOU14	690,-	1400	600	740	32.9 kg 0.073 m3 4 szt.	
BOU16	710,-	1600	600	740	36.2 kg 0.078 m3 4 szt.	
BOU49	650,-	1000	700	740	26.7 kg 0.068 m3 4 szt.	
BOU28	675,-	1200	700	740	34.4 kg 0.078 m3 4 szt.	
BOU29	700,-	1400	700	740	61 kg 0.125 m3 5 szt.	
BOU30	720,-	1600	700	740	61.55 kg 0.137 m3 5 szt.	
BOU19	690,-	1200	800	740	37 kg 0.07 m3 3 szt.	
BOU20	715,-	1400	800	740	39.5 kg 0.077 m3 3 szt.	
BOU21	730,-	1600	800	740	44.55 kg 0.084 m3 3 szt.	
BOU22	830,-	1800	800	740	48.55 kg 0.091 m3 3 szt.	
BOU27	880,-	2000	800	740	48.9 kg 0.099 m3 5 szt.	

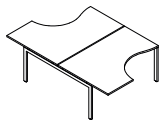
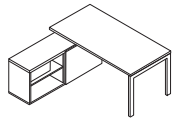
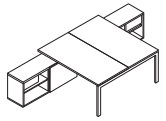

Dodatkowa dopłata							
Mediabox M04H	Mediabox M04	Top access	Przepusty kablowe	Wycięcie kablowe	Wycięcie pod mediabox		
315,-	295,-	105,-	42,-	105,-	11,-		
315,-	295,-	105,-	42,-	105,-	11,-		
315,-	295,-	105,-	42,-	105,-	11,-		
315,-	295,-	105,-	42,-	105,-	11,-		
315,-	295,-	105,-	42,-	105,-	11,-		
315,-	295,-	105,-	42,-	105,-	11,-		
315,-	295,-	105,-	42,-	105,-	11,-		
315,-	295,-	105,-	42,-	105,-	11,-		
315,-	295,-	105,-	42,-	105,-	11,-		
315,-	295,-	105,-	42,-	105,-	11,-		
315,-	295,-	105,-	42,-	105,-	11,-		
315,-	295,-	105,-	42,-	105,-	11,-		
315,-	295,-	105,-	42,-	105,-	11,-		

Bierka kształtowe							
	Symbol	Cena netto PLN	Wymiary			Waga Obj. Opak.	Uwagi
			Szer.	Gł.	Wys.		
	BOU23	915,-	1600	1200	740	48.35 kg 0.109 m3 3 szt.	brak elementów do rozbudowy, należy zastosować odpowiednią nogę podpierającą
	BOU25	1100,-	1800	1200	740	51.2 kg 0.119 m3 3 szt.	
	BOU24	915,-	1600	1200	740	47.65 kg 0.109 m3 3 szt.	
	BOU26	1100,-	1800	1200	740	50.85 kg 0.119 m3 3 szt.	
	BOU15	1800,-	1600	2410	740	89.3 kg 0.216 m3 5 szt.	
Bierka z szafką managerską							
	BOUL20	2000,-	1702 1600	1600	740	103.15 kg 0.232 m3 8 szt.	uniwersalne (lewe / prawe);
	BOUL21	2080,-	1902 1800	1600	740	107.15 kg 0.239 m3 8 szt.	
	BOUL40	3980,-	1702 1600	3210	740	203.1 kg 0.465 m3 15 szt.	
	BOUL41	4160,-	1902 1800	3210	740	211.1 kg 0.478 m3 15 szt.	

Dodatkowa dopłata							
Mediabox M04H	Mediabox M04	Top access	II grupa cenowa	Przepusty kablowe	Wycięcie kablowe	Wycięcie pod mediabox	
315,-	295,-	105,-		42,-	105,-	11,-	
315,-	295,-	105,-		42,-	105,-	11,-	
315,-	295,-	105,-		42,-	105,-	11,-	
315,-	295,-	105,-		42,-	105,-	11,-	
630,-	590,-	210,-		84,-	210,-	22,-	
315,-	295,-	105,-	80,-	42,-	105,-	11,-	
315,-	295,-	105,-	80,-	42,-	105,-	11,-	
630,-	590,-	210,-	160,-	84,-	210,-	22,-	
630,-	590,-	210,-	160,-	84,-	210,-	22,-	

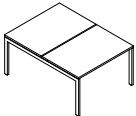
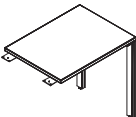
Biuorka typu bench							
	Symbol	Cena netto PLN	Wymiary			Waga Obj. Opak.	Uwagi
			Szer.	Gł.	Wys.		
	BOU50	1010,-	1000	1210	740	44.6 kg 0.12 m3 5 szt.	tworzenie układów, patrz: Ogi M, Ogi Q, Ogi U, Ogi Y - elementy do rozbudowy
	BOU52	1050,-	1200	1210	740	48.6 kg 0.129 m3 5 szt.	
	BOU54	1080,-	1400	1210	740	54 kg 0.139 m3 5 szt.	
	BOU56	1130,-	1600	1210	740	61 kg 0.148 m3 5 szt.	
	BOU48	1030,-	1000	1410	740	45.9 kg 0.102 m3 5 szt.	
	BOU42	1070,-	1200	1410	740	61.3 kg 0.122 m3 5 szt.	
	BOU44	1110,-	1400	1410	740	64.5 kg 0.134 m3 5 szt.	
	BOU46	1160,-	1600	1410	740	71.6 kg 0.147 m3 5 szt.	
	BOU32	1090,-	1200	1610	740	67.3 kg 0.138 m3 5 szt.	
	BOU33	1130,-	1400	1610	740	72.3 kg 0.152 m3 5 szt.	
	BOU34	1180,-	1600	1610	740	82.4 kg 0.166 m3 5 szt.	
	BOU35	1360,-	1800	1610	740	90.4 kg 0.179 m3 5 szt.	
Przystawki do biurek							
	PLU01	540,-	600	800	740	17.8 kg 0.038 m3 5 szt.	
	PLU02	585,-	600	1000	740	19.8 kg 0.043 m3 5 szt.	
	PLU03	615,-	600	1200	740	22 kg 0.048 m3 5 szt.	

Dodatkowa dopłata							
Mediabox M04H	Mediabox M04	Top access	Przepusty kablowe	Wycięcie kablowe	Wycięcie pod mediabox		
630,-	590,-	210,-	84,-	210,-	22,-		
630,-	590,-	210,-	84,-	210,-	22,-		
630,-	590,-	210,-	84,-	210,-	22,-		
630,-	590,-	210,-	84,-	210,-	22,-		
630,-	590,-	210,-	84,-	210,-	22,-		
630,-	590,-	210,-	84,-	210,-	22,-		
630,-	590,-	210,-	84,-	210,-	22,-		
630,-	590,-	210,-	84,-	210,-	22,-		
630,-	590,-	210,-	84,-	210,-	22,-		
630,-	590,-	210,-	84,-	210,-	22,-		
630,-	590,-	210,-	84,-	210,-	22,-		
630,-	590,-	210,-	84,-	210,-	22,-		
630,-	590,-	210,-	84,-	210,-	22,-		
630,-	590,-	210,-	84,-	210,-	22,-		
630,-	590,-	210,-	84,-	210,-	22,-		
630,-	590,-	210,-	84,-	210,-	22,-		
630,-	590,-	210,-	84,-	210,-	22,-		
630,-	590,-	210,-	84,-	210,-	22,-		
630,-	590,-	210,-	84,-	210,-	22,-		
630,-	590,-	210,-	84,-	210,-	22,-		
630,-	590,-	210,-	84,-	210,-	22,-		

Biuorka proste							
Symbol	Cena netto PLN	Wymiary			Waga Obj. Opak.	Uwagi	
		Szer.	Gł.	Wys.			
BOY01	610,-	1000	600	740	27.3 kg 0.068 m3 4 szt.	tworzenie układów, patrz: elementy do rozbudowy - Ogi M, Ogi Q, Ogi U, Ogi Y	
BOY12	635,-	1200	600	740	31 kg 0.076 m3 4 szt.		
BOY14	650,-	1400	600	740	33.5 kg 0.082 m3 4 szt.		
BOY16	670,-	1600	600	740	36.8 kg 0.087 m3 4 szt.		
BOY20	620,-	1000	700	740	26.1 kg 0.057 m3 3 szt.		
BOY22	640,-	1200	700	740	33.8 kg 0.067 m3 3 szt.		
BOY24	655,-	1400	700	740	35.4 kg 0.073 m3 3 szt.		
BOY26	675,-	1600	700	740	38.95 kg 0.079 m3 3 szt.		
BOY02	650,-	1200	800	740	36.8 kg 0.076 m3 3 szt.		
BOY03	670,-	1400	800	740	39.3 kg 0.083 m3 3 szt.		
BOY04	690,-	1600	800	740	44.35 kg 0.09 m3 3 szt.		
BOY05	775,-	1800	800	740	48.35 kg 0.096 m3 3 szt.		
BOY06	805,-	2000	800	740	48.7 kg 0.105 m3 5 szt.		

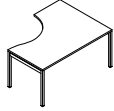
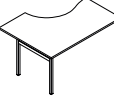
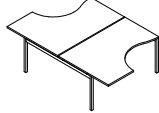
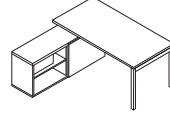
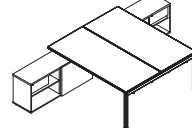
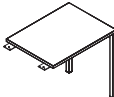

Dodatkowa dopłata							
Mediabox M04H	Mediabox M04	Top access	Przepusty kablowe	Wycięcie kablowe	Wycięcie pod mediabox		
315,-	295,-	105,-	42,-	105,-	11,-		
315,-	295,-	105,-	42,-	105,-	11,-		
315,-	295,-	105,-	42,-	105,-	11,-		
315,-	295,-	105,-	42,-	105,-	11,-		
315,-	295,-	105,-	42,-	105,-	11,-		
315,-	295,-	105,-	42,-	105,-	11,-		
315,-	295,-	105,-	42,-	105,-	11,-		
315,-	295,-	105,-	42,-	105,-	11,-		
315,-	295,-	105,-	42,-	105,-	11,-		
315,-	295,-	105,-	42,-	105,-	11,-		
315,-	295,-	105,-	42,-	105,-	11,-		
315,-	295,-	105,-	42,-	105,-	11,-		

Bierka kształtowe							
	Symbol	Cena netto PLN	Wymiary			Waga Obj. Opak.	Uwagi
			Szer.	Gł.	Wys.		
	BOY10	845,-	1600	1200	740	48.15 kg 0.115 m3 3 szt.	brak elementów do rozbudowy, należy zastosować odpowiednią nogę podpierającą
	BOY17	1000,-	1800	1200	740	51 kg 0.124 m3 3 szt.	
	BOY11	845,-	1600	1200	740	47.45 kg 0.115 m3 3 szt.	
	BOY18	1000,-	1800	1200	740	50.65 kg 0.124 m3 3 szt.	
	BOY15	1500,-	1600	2410	740	88.7 kg 0.228 m3 5 szt.	
Bierka z szafką managerską							
	BOYL20	1870,-	1702 1600	1600	740	104.35 kg 0.246 m3 9 szt.	uniwersalne (lewe / prawe);
	BOYL21	1950,-	1902 1800	1600	740	106.75 kg 0.245 m3 8 szt.	
	BOYL40	3580,-	1702 1600	3210	740	202.4 kg 0.476 m3 15 szt.	
	BOYL41	3760,-	1902 1800	3210	740	210.4 kg 0.49 m3 15 szt.	
Przystawki do biur							
	PLY01	475,-	600	800	740	18.1 kg 0.042 m3 5 szt.	
	PLY02	510,-	600	1000	740	20.1 kg 0.047 m3 5 szt.	
	PLY03	555,-	600	1200	740	22.3 kg 0.052 m3 5 szt.	

Dodatkowa dopłata							
Mediabox M04H	Mediabox M04	Top access	II grupa cenowa	Przepusty kablowe	Wycięcie kablowe	Wycięcie pod mediabox	
315,-	295,-	105,-		42,-	105,-	11,-	
315,-	295,-	105,-		42,-	105,-	11,-	
315,-	295,-	105,-		42,-	105,-	11,-	
315,-	295,-	105,-		42,-	105,-	11,-	
630,-	590,-	210,-		84,-	210,-	22,-	
315,-	295,-	105,-	80,-	42,-	105,-	11,-	
315,-	295,-	105,-	80,-	42,-	105,-	11,-	
630,-	590,-	210,-	160,-	84,-	210,-	22,-	
630,-	590,-	210,-	160,-	84,-	210,-	22,-	

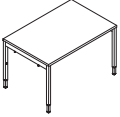

Bierka z manualną regulacją wysokości							
	Symbol	Cena netto PLN	Wymiary			Waga Obj. Opak.	Uwagi
			Szer.	Gł.	Wys.		
	BOY02R	1000,-	1200	800	860 640	38.8 kg 0.076 m3 3 szt.	regulacja wysokości w zakresie 640 - 860mm, skokowo co 20mm
	BOY03R	1020,-	1400	800	860 640	41.3 kg 0.083 m3 3 szt.	
	BOY04R	1060,-	1600	800	860 640	46.35 kg 0.09 m3 3 szt.	
	BOY05R	1120,-	1800	800	860 640	50.35 kg 0.096 m3 3 szt.	
	BOY06R	1150,-	2000	800	860 640	50.35 kg 0.103 m3 3 szt.	

Dodatkowa dopłata							
Mediabox M04H	Mediabox M04	Top access	Przepusty kablowe	Wycięcie kablowe	Wycięcie pod mediabox		
315,-	295,-	105,-	42,-	105,-	11,-		
315,-	295,-	105,-	42,-	105,-	11,-		
315,-	295,-	105,-	42,-	105,-	11,-		
315,-	295,-	105,-	42,-	105,-	11,-		
315,-	295,-	105,-	42,-	105,-	11,-		

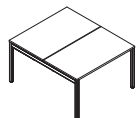
Biuorka typu bench						
Symbol	Cena netto PLN	Wymiary			Waga Obj. Opak.	Uwagi
		Szer.	Gł.	Wys.		
BOY50	955,-	1000	1210	740	43.3 kg 0.098 m3 5 szt.	tworzenie układów, patrz: elementy do rozbudowy - Ogi M, Ogi Q, Ogi U, Ogi Y
BOY52	990,-	1200	1210	740	47.3 kg 0.107 m3 5 szt.	
BOY54	1030,-	1400	1210	740	52.7 kg 0.117 m3 5 szt.	
BOY56	1070,-	1600	1210	740	59.7 kg 0.126 m3 5 szt.	
BOY40	980,-	1000	1410	740	46 kg 0.113 m3 5 szt.	
BOY42	1010,-	1200	1410	740	61.4 kg 0.132 m3 5 szt.	
BOY44	1050,-	1400	1410	740	64.6 kg 0.145 m3 5 szt.	
BOY46	1120,-	1600	1410	740	71.7 kg 0.157 m3 5 szt.	
BOY32	1050,-	1200	1610	740	66.7 kg 0.15 m3 5 szt.	
BOY33	1080,-	1400	1610	740	71.7 kg 0.164 m3 5 szt.	
BOY34	1130,-	1600	1610	740	81.8 kg 0.178 m3 5 szt.	
BOY35	1300,-	1800	1610	740	89.8 kg 0.191 m3 5 szt.	

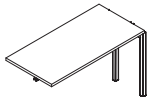
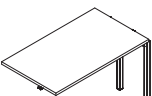

Dodatkowa dopłata							
Mediabox M04H	Mediabox M04	Top access	Przepusty kablowe	Wycięcie kablowe	Wycięcie pod mediabox		
630,-	590,-	210,-	84,-	210,-	22,-		
630,-	590,-	210,-	84,-	210,-	22,-		
630,-	590,-	210,-	84,-	210,-	22,-		
630,-	590,-	210,-	84,-	210,-	22,-		
630,-	590,-	210,-	84,-	210,-	22,-		
630,-	590,-	210,-	84,-	210,-	22,-		
630,-	590,-	210,-	84,-	210,-	22,-		
630,-	590,-	210,-	84,-	210,-	22,-		
630,-	590,-	210,-	84,-	210,-	22,-		
630,-	590,-	210,-	84,-	210,-	22,-		
630,-	590,-	210,-	84,-	210,-	22,-		

Elementy do tworzenia układów - biurka proste, głębokość 600 mm							
	Symbol	Cena netto PLN	Wymiary			Waga Obj. Opak.	Uwagi
			Szer.	Gł.	Wys.		
	BOX10	540,-	1000	600	740	20.7 kg 0.06 m3 3 szt.	mocowanie wyłącznie do krawędzi 600 mm, profil 40 x 40 mm, wyłącznie do biurek Ogi M, Ogi Y
	BOX12	555,-	1200	600	740	22.7 kg 0.064 m3 3 szt.	
	BOX14	570,-	1400	600	740	25.4 kg 0.069 m3 3 szt.	
	BOX16	595,-	1600	600	740	28.9 kg 0.074 m3 3 szt.	
Elementy do tworzenia układów - biurka proste, głębokość 700 mm							
	BOX30	545,-	1000	700	740	20.7 kg 0.059 m3 3 szt.	mocowanie wyłącznie do krawędzi 700 mm, profil 40 x 40 mm, wyłącznie do biurek Ogi M, Ogi Y
	BOX32	560,-	1200	700	740	28.4 kg 0.069 m3 3 szt.	
	BOX34	585,-	1400	700	740	30 kg 0.075 m3 3 szt.	
	BOX36	600,-	1600	700	740	33.55 kg 0.081 m3 3 szt.	
Elementy do tworzenia układów - biurka proste, głębokość 800 mm							
	BOX40	460,-	500	800	740	11 kg 0.053 m3 2 szt.	mocowanie wyłącznie do krawędzi 800mm, profil 40x40, wyłącznie do biurek Ogi M, Ogi Q, Ogi U, Ogi Y
	BOX42	565,-	1200	800	740	30.8 kg 0.08 m3 3 szt.	
	BOX43	590,-	1400	800	740	33.3 kg 0.087 m3 3 szt.	
	BOX44	605,-	1600	800	740	38.35 kg 0.094 m3 3 szt.	
	BOX45	645,-	1800	800	740	42.35 kg 0.101 m3 3 szt.	

Dodatkowa dopłata							
Mediabox M04H	Mediabox M04	Top access	Przepusty kablowe	Wycięcie kablowe	Wycięcie pod mediabox		
315,-	295,-	105,-	42,-	105,-	11,-		
315,-	295,-	105,-	42,-	105,-	11,-		
315,-	295,-	105,-	42,-	105,-	11,-		
315,-	295,-	105,-	42,-	105,-	11,-		
315,-	295,-	105,-	42,-	105,-	11,-		
315,-	295,-	105,-	42,-	105,-	11,-		
315,-	295,-	105,-	42,-	105,-	11,-		
315,-	295,-	105,-	42,-	105,-	11,-		
315,-	295,-	105,-	42,-	105,-	11,-		
315,-	295,-	105,-	42,-	105,-	11,-		
315,-	295,-	105,-	42,-	105,-	11,-		
315,-	295,-	105,-	42,-	105,-	11,-		

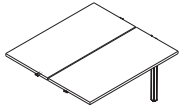
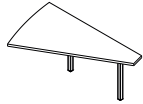
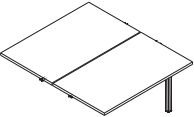
Elementy do tworzenia układów - bench, głębokość 1210 mm							
	Symbol	Cena netto PLN	Wymiary			Waga Obj. Opak.	Uwagi
			Szer.	Gł.	Wys.		
	BOX20	830,-	1000	1210	740	36.6 kg 0.1 m3 5 szt.	mocowanie wyłącznie do krawędzi 1210mm, profil 40x40, wyłącznie do biurek Ogi M, Ogi Y, stoły konferencyjne SY
	BOX22	870,-	1200	1210	740	40.6 kg 0.109 m3 5 szt.	
	BOX24	910,-	1400	1210	740	46 kg 0.119 m3 5 szt.	
	BOX26	965,-	1600	1210	740	53 kg 0.128 m3 5 szt.	
Elementy do tworzenia układów - bench, głębokość 1410 mm							
	BOX50	655,-	1000	1410	740	24.05 kg 0.122 m3 2 szt.	mocowanie wyłącznie do krawędzi 1410mm, profil 40x40, wyłącznie do biurek Ogi M, Ogi Y, stoły konferencyjne SY
	BOX51	840,-	1000	1410	740	38.2 kg 0.119 m3 5 szt.	
	BOX52	880,-	1200	1410	740	53.6 kg 0.138 m3 5 szt.	
	BOX54	920,-	1400	1410	740	56.8 kg 0.151 m3 5 szt.	
	BOX56	975,-	1600	1410	740	63.9 kg 0.163 m3 5 szt.	

Dodatkowa dopłata							
Mediabox M04H	Mediabox M04	Top access	Przepusty kablowe	Wycięcie kablowe	Wycięcie pod mediabox		
630,-	590,-	210,-	84,-	210,-	22,-		
630,-	590,-	210,-	84,-	210,-	22,-		
630,-	590,-	210,-	84,-	210,-	22,-		
630,-	590,-	210,-	84,-	210,-	22,-		
630,-	590,-	210,-	84,-	210,-	22,-		
630,-	590,-	210,-	84,-	210,-	22,-		
630,-	590,-	210,-	84,-	210,-	22,-		
630,-	590,-	210,-	84,-	210,-	22,-		

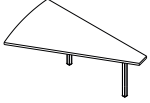
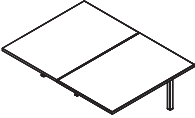
Elementy do tworzenia układów - bench, głębokość 1610 mm							
	Symbol	Cena netto PLN	Wymiary			Waga Obj. Opak.	Uwagi
			Szer.	Gł.	Wys.		
	BOX60	720,-	1000	1610	740	28.75 kg 0.134 m3 2 szt.	mocowanie wyłącznie do krawędzi 1610mm, profil 40x40, wyłącznie do biurek Ogi M, Ogi Y, stoły konferencyjne SY
	BOX62	915,-	1200	1610	740	58.35 kg 0.16 m3 5 szt.	
	BOX64	940,-	1400	1610	740	63.35 kg 0.174 m3 5 szt.	
	BOX66	1000,-	1600	1610	740	73.45 kg 0.188 m3 5 szt.	
	BOX68	1150,-	1800	1610	740	81.45 kg 0.201 m3 5 szt.	

Dodatkowa dopłata							
Mediabox M04H	Mediabox M04	Top access	Przepusty kablowe	Wycięcie kablowe	Wycięcie pod mediabox		
630,-	590,-	210,-	84,-	210,-	22,-		
630,-	590,-	210,-	84,-	210,-	22,-		
630,-	590,-	210,-	84,-	210,-	22,-		
630,-	590,-	210,-	84,-	210,-	22,-		

Biuorka proste							
Symbol	Cena netto PLN	Wymiary			Waga Obj. Opak.	Uwagi	
		Szer.	Gł.	Wys.			
BOW10	1030,-	1000	600	740	23.3 kg 0.064 m3 3 szt.		
BOW12	1050,-	1200	600	740	25.3 kg 0.069 m3 3 szt.		
BOW14	1080,-	1400	600	740	44 kg 0.105 m3 4 szt.		
BOW16	1090,-	1600	600	740	31.5 kg 0.079 m3 3 szt.		
BOW19	1040,-	1000	700	740	23.3 kg 0.074 m3 3 szt.		
BOW22	1060,-	1200	700	740	31 kg 0.084 m3 3 szt.		
BOW24	1090,-	1400	700	740	57.6 kg 0.131 m3 4 szt.		
BOW26	1100,-	1600	700	740	36.15 kg 0.096 m3 3 szt.		
BOW02	1080,-	1200	800	740	34 kg 0.095 m3 3 szt.		
BOW03	1100,-	1400	800	740	36.5 kg 0.102 m3 3 szt.		
BOW04	1120,-	1600	800	740	41.55 kg 0.109 m3 3 szt.		
BOW05	1200,-	1800	800	740	45.55 kg 0.116 m3 3 szt.		
BOW06	1230,-	2000	800	740	45.55 kg 0.122 m3 3 szt.		
BOW07	1260,-	2000	1000	740	56.7 kg 0.157 m3 5 szt.		

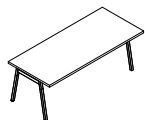

Dodatkowa dopłata							
Mediabox M04H	Mediabox M04	Top access	Przepusty kablowe	Obrzeże naturalne	Wycięcie kablowe	Wycięcie pod mediabox	
315,-	295,-	105,-	42,-	105,-	105,-	11,-	
315,-	295,-	105,-	42,-	105,-	105,-	11,-	
315,-	295,-	105,-	42,-	105,-	105,-	11,-	
315,-	295,-	105,-	42,-	105,-	105,-	11,-	
315,-	295,-	105,-	42,-	105,-	105,-	11,-	
315,-	295,-	105,-	42,-	105,-	105,-	11,-	
315,-	295,-	105,-	42,-	105,-	105,-	11,-	
315,-	295,-	105,-	42,-	105,-	105,-	11,-	
315,-	295,-	105,-	42,-	105,-	105,-	11,-	
315,-	295,-	105,-	42,-	105,-	105,-	11,-	
315,-	295,-	105,-	42,-	105,-	105,-	11,-	
315,-	295,-	105,-	42,-	105,-	105,-	11,-	
315,-	295,-	105,-	42,-	105,-	105,-	11,-	

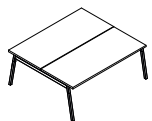

Biuurka typu bench							
Symbol	Cena netto PLN	Wymiary			Waga Obj. Opak.	Uwagi	
		Szer.	Gł.	Wys.			
BOW50	1370,-	1000	1210	740	41.6 kg 0.128 m3 5 szt.		
BOW52	1410,-	1200	1210	740	45.6 kg 0.138 m3 5 szt.		
BOW54	1440,-	1400	1210	740	51 kg 0.148 m3 5 szt.		
BOW56	1510,-	1600	1210	740	58 kg 0.157 m3 5 szt.		
BOW48	1400,-	1000	1410	740	42.6 kg 0.148 m3 5 szt.		
BOW42	1430,-	1200	1410	740	58 kg 0.168 m3 5 szt.		
BOW44	1470,-	1400	1410	740	61.2 kg 0.18 m3 5 szt.		
BOW46	1530,-	1600	1410	740	68.3 kg 0.193 m3 5 szt.		
BOW32	1460,-	1200	1610	740	63 kg 0.191 m3 5 szt.		
BOW33	1500,-	1400	1610	740	68 kg 0.205 m3 5 szt.		
BOW34	1550,-	1600	1610	740	78.1 kg 0.219 m3 5 szt.		
BOW35	1710,-	1800	1610	740	86.1 kg 0.232 m3 5 szt.		

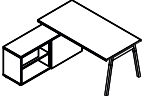
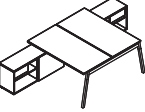
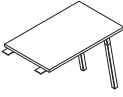

Dodatkowa dopłata							
Mediabox M04H	Mediabox M04	Top access	Przepusty kablowe	Obrzeże naturalne	Wycięcie kablowe	Wycięcie pod mediabox	
630,-	590,-	210,-	84,-	210,-	210,-	22,-	
630,-	590,-	210,-	84,-	210,-	210,-	22,-	
630,-	590,-	210,-	84,-	210,-	210,-	22,-	
630,-	590,-	210,-	84,-	210,-	210,-	22,-	
630,-	590,-	210,-	84,-	210,-	210,-	22,-	
630,-	590,-	210,-	84,-	210,-	210,-	22,-	
630,-	590,-	210,-	84,-	210,-	210,-	22,-	
630,-	590,-	210,-	84,-	210,-	210,-	22,-	
630,-	590,-	210,-	84,-	210,-	210,-	22,-	
630,-	590,-	210,-	84,-	210,-	210,-	22,-	

Biuorka z szafką managerską							
	Symbol	Cena netto PLN	Wymiary			Waga Obj. Opak.	Uwagi
			Szer.	Gł.	Wys.		
	BOW20	2050,-	1702 1600	1600	740	102.25 kg 0.239 m3 9 szt.	uniwersalne (lewe / prawe)
	BOW21	2130,-	1902 1800	1600	740	104.65 kg 0.238 m3 8 szt.	
	BOW40	3720,-	1702 1600	3210	740	199.3 kg 0.509 m3 15 szt.	
	BOW41	3880,-	1902 1800	3210	740	207.3 kg 0.522 m3 15 szt.	
Przystawki do biurerek							
	PLW01	745,-	600	800	740	15.05 kg 0.024 m3 5 szt.	
	PLW02	765,-	600	1000	740	16.05 kg 0.029 m3 5 szt.	
	PLW03	785,-	600	1200	740	18.05 kg 0.034 m3 5 szt.	



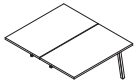
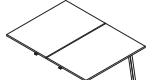

Dodatkowa dopłata							
Mediabox M04H	Mediabox M04	Top access	II grupa cenowa	Przepusty kablowe	Obrzeże naturalne	Wycięcie kablowe	Wycięcie pod mediabox
315,-	295,-	105,-	80,-	42,-	105,-	105,-	11,-
315,-	295,-	105,-	80,-	42,-	105,-	105,-	11,-
630,-	590,-	210,-	160,-	84,-	210,-	210,-	22,-
630,-	590,-	210,-	160,-	84,-	210,-	210,-	22,-

Elementy do tworzenia układów - biurka proste, noga drewniana, głębokość 700 mm							
	Symbol	Cena netto PLN	Wymiary			Waga Obj. Opak.	Uwagi
			Szer.	Gł.	Wys.		
	BOW22L	955,-	1200	700	740	26.9 kg 0.084 m3 3 szt.	mocowanie wyłącznie do krawędzi 700 mm, profil 40 x 40 mm
	BOW24L	980,-	1400	700	740	28.5 kg 0.09 m3 3 szt.	
	BOW26L	990,-	1600	700	740	32.05 kg 0.096 m3 3 szt.	
Elementy do tworzenia układów - biurka proste, noga drewniana, głębokość 800 mm							
	BOW02L	970,-	1200	800	740	29.2 kg 0.095 m3 3 szt.	mocowanie wyłącznie do krawędzi 800mm, profil 40x40
	BOW03L	990,-	1400	800	740	31.7 kg 0.102 m3 3 szt.	
	BOW04L	1000,-	1600	800	740	36.75 kg 0.109 m3 3 szt.	
	BOW05L	1080,-	1800	800	740	40.75 kg 0.116 m3 3 szt.	
Elementy do tworzenia układów - bench, noga drewniana, głębokość 1410 mm							
	BOW42L	1240,-	1200	1410	740	52.2 kg 0.168 m3 5 szt.	mocowanie wyłącznie do krawędzi 1410mm, profil 40x40
	BOW44L	1280,-	1400	1410	740	55.4 kg 0.18 m3 5 szt.	
	BOW46L	1330,-	1600	1410	740	62.5 kg 0.193 m3 5 szt.	
Elementy do tworzenia układów - bench, noga drewniana, głębokość 1610 mm							
	BOW32L	1270,-	1200	1610	740	56.8 kg 0.191 m3 5 szt.	mocowanie wyłącznie do krawędzi 1610mm, profil 40x40
	BOW33L	1300,-	1400	1610	740	61.8 kg 0.205 m3 5 szt.	
	BOW34L	1350,-	1600	1610	740	71.9 kg 0.219 m3 5 szt.	
	BOW35L	1490,-	1800	1610	740	79.9 kg 0.232 m3 5 szt.	

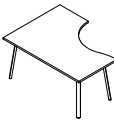

Dodatkowa dopłata							
Mediabox M04H	Mediabox M04	Top access	Przepusty kablowe	Obrzeże naturalne	Wycięcie kablowe	Wycięcie pod mediabox	
315,-	295,-	105,-	42,-	105,-	105,-	11,-	
315,-	295,-	105,-	42,-	105,-	105,-	11,-	
315,-	295,-	105,-	42,-	105,-	105,-	11,-	
315,-	295,-	105,-	42,-	105,-	105,-	11,-	
315,-	295,-	105,-	42,-	105,-	105,-	11,-	
630,-	590,-	210,-	84,-	210,-	210,-	22,-	
630,-	590,-	210,-	84,-	210,-	210,-	22,-	
630,-	590,-	210,-	84,-	210,-	210,-	22,-	
630,-	590,-	210,-	84,-	210,-	210,-	22,-	
630,-	590,-	210,-	84,-	210,-	210,-	22,-	
630,-	590,-	210,-	84,-	210,-	210,-	22,-	
630,-	590,-	210,-	84,-	210,-	210,-	22,-	
630,-	590,-	210,-	84,-	210,-	210,-	22,-	

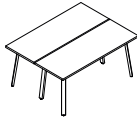
Biuorka proste							
	Symbol	Cena netto PLN	Wymiary			Waga Obj. Opak.	Uwagi
			Szer.	Gł.	Wys.		
	BAG016	550,-	1000	600	740	19.5 kg 0.03 m3 5 szt.	
	BAG026	560,-	1200	600	740	23 kg 0.035 m3 5 szt.	
	BAG036	570,-	1400	600	740	25.25 kg 0.039 m3 5 szt.	
	BAG046	590,-	1600	600	740	29.1 kg 0.051 m3 6 szt.	
	BAG017	560,-	1000	700	740	22 kg 0.034 m3 5 szt.	
	BAG027	570,-	1200	700	740	25.15 kg 0.039 m3 5 szt.	
	BAG037	590,-	1400	700	740	28.2 kg 0.044 m3 5 szt.	
	BAG047	600,-	1600	700	740	30.6 kg 0.049 m3 5 szt.	
	BAG028	590,-	1200	800	740	29.35 kg 0.049 m3 6 szt.	
	BAG038	600,-	1400	800	740	31.5 kg 0.049 m3 5 szt.	
	BAG048	610,-	1600	800	740	34.1 kg 0.055 m3 5 szt.	

Dodatkowa dopłata							
Mediabox M04H	Mediabox M04	Top access	Przepusty kablowe	Wycięcie pod mediabox			
315,-	295,-	105,-	42,-	11,-			
315,-	295,-	105,-	42,-	11,-			
315,-	295,-	105,-	42,-	11,-			
315,-	295,-	105,-	42,-	11,-			
315,-	295,-	105,-	42,-	11,-			
315,-	295,-	105,-	42,-	11,-			
315,-	295,-	105,-	42,-	11,-			
315,-	295,-	105,-	42,-	11,-			
315,-	295,-	105,-	42,-	11,-			
315,-	295,-	105,-	42,-	11,-			

Biuorka kształtowe							
	Symbol	Cena netto PLN	Wymiary			Waga Obj. Opak.	Uwagi
			Szer.	Gł.	Wys.		
	BAG10	760,-	1600	1200	740	40.05 kg 0.078 m3 5 szt.	brak elementów do rozbudowy, należy zastosować odpowiednią nogę podpierającą
	BAG11	760,-	1600	1200	740	41.45 kg 0.078 m3 5 szt.	brak elementów do rozbudowy, należy zastosować odpowiednią nogę podpierającą
	BAG12	2060,-	2343	2029	740	89.1 kg 0.198 m3 15 szt.	możliwość zastosowania paneli ZOT78, ZOT79, ZOS78, ZOS79
Biuorka typu bench							
	BAG0214	1020,-	1600	1210	740	51 kg 0.082 m3 8 szt.	możliwość montażu wyłącznie szyny SG220
	BAG0216	1050,-	1600	1410	740	57.2 kg 0.094 m3 8 szt.	
	BAG0218	1080,-	1600	1610	740	64.2 kg 0.105 m3 8 szt.	
Elementy do tworzenia układów biurek							
	BAG0414	670,-	1600	1210	740	45 kg 0.076 m3 5 szt.	środkowa noga prosta wykonana z profilu 40x40
	BAG0416	690,-	1600	1410	740	51.2 kg 0.088 m3 5 szt.	
	BAG0418	725,-	1600	1610	740	58.2 kg 0.099 m3 5 szt.	

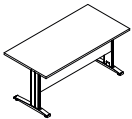

Dodatkowa dopłata							
Mediabox M04H	Mediabox M04	Top access	Przepusty kablowe	Wycięcie pod mediabox			
315,-	295,-	105,-	42,-	11,-			
315,-	295,-	105,-	42,-	11,-			
630,-	590,-	210,-	84,-	22,-			
630,-	590,-	210,-	84,-	22,-			
630,-	590,-	210,-	84,-	22,-			
630,-	590,-	210,-	84,-	22,-			
630,-	590,-	210,-	84,-	22,-			
630,-	590,-	210,-	84,-	22,-			

Biuorka proste							
	Symbol	Cena netto PLN	Wymiary			Waga Obj. Opak.	Uwagi
			Szer.	Gł.	Wys.		
	BNG02	655,-	1200	800	740	53.901 kg 0.14 m3 4 szt.	
	BNG03	680,-	1400	800	740	63.001 kg 0.154 m3 4 szt.	
	BNG04	715,-	1600	800	740	71.651 kg 0.175 m3 4 szt.	
	BNG05	760,-	1800	800	740	76.051 kg 0.176 m3 4 szt.	
	Biuorka kształtowe						
	BNG10	915,-	1600	1200	740	81.951 kg 0.225 m3 4 szt.	brak elementów do rozbudowy, należy zastosować odpowiednią nogę podpierającą
	BNG17	1020,-	1800	1200	740	88.001 kg 0.239 m3 4 szt.	
	BNG11	915,-	1600	1200	740	80.751 kg 0.225 m3 4 szt.	brak elementów do rozbudowy, należy zastosować odpowiednią nogę podpierającą
	BNG18	1020,-	1800	1200	740	88.401 kg 0.226 m3 4 szt.	

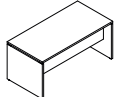
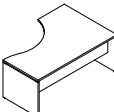
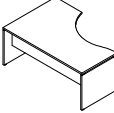



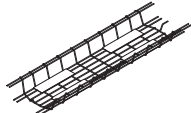
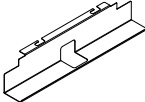
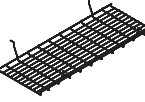

Dodatkowa dopłata							
Mediabox M04H	Mediabox M04	Top access	Przepusty kablowe	Wycięcie kablowe	Wycięcie pod mediabox		
315,-	295,-	105,-	42,-	105,-	11,-		
315,-	295,-	105,-	42,-	105,-	11,-		
315,-	295,-	105,-	42,-	105,-	11,-		
315,-	295,-	105,-	42,-	105,-	11,-		
315,-	295,-	105,-	42,-	105,-	11,-		
315,-	295,-	105,-	42,-	105,-	11,-		
315,-	295,-	105,-	42,-	105,-	11,-		
315,-	295,-	105,-	42,-	105,-	11,-		

Biuorka proste							
	Symbol	Cena netto PLN	Wymiary			Waga Obj. Opak.	Uwagi
			Szer.	Gł.	Wys.		
	BVG02	470,-	1200	800	740	68.05 kg 0.136 m ³ 4 szt.	odległość do łączyny pod blatem 547mm - nie mieści kontenera
	BVG03	510,-	1400	800	740	76.9 kg 0.15 m ³ 4 szt.	
	BVG04	555,-	1600	800	740	85.2 kg 0.166 m ³ 4 szt.	
	BVG05	610,-	1800	800	740	90.55 kg 0.172 m ³ 4 szt.	
Biuorka kształtowe							
	BVG10	765,-	1600	1200	740	95.5 kg 0.215 m ³ 4 szt.	odległość do łączyny pod blatem 547mm (przy węższej krawędzi); - nie mieści kontenera
	BVG17	820,-	1800	1200	740	102.5 kg 0.235 m ³ 4 szt.	
	BVG11	765,-	1600	1200	740	94.3 kg 0.215 m ³ 4 szt.	odległość do łączyny pod blatem 547mm (przy węższej krawędzi); - nie mieści kontenera
	BVG18	820,-	1800	1200	740	102.9 kg 0.223 m ³ 4 szt.	



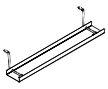
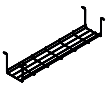
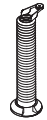



Dodatkowa dopłata							
Mediabox M04H	Mediabox M04	Top access	Przepusty kablowe	Wycięcie kablowe	Wycięcie pod mediabox		
315,-	295,-	105,-	42,-	105,-	11,-		
315,-	295,-	105,-	42,-	105,-	11,-		
315,-	295,-	105,-	42,-	105,-	11,-		
315,-	295,-	105,-	42,-	105,-	11,-		
315,-	295,-	105,-	42,-	105,-	11,-		
315,-	295,-	105,-	42,-	105,-	11,-		
315,-	295,-	105,-	42,-	105,-	11,-		

Akcesoria							
	Symbol	Cena netto PLN	Wymiary			Waga Obj. Opak.	Uwagi
			Szer.	Gł.	Wys.		
	SOD12	305,-	1200	290	77	2 kg 0.024 m3 1 szt.	pasuje do biurk BOD512, BOD612, BOC30
	SOD14	320,-	1400	290	77	2.5 kg 0.028 m3 1 szt.	pasuje do biurk BOD514, BOD614, BOC40
	SOD16	335,-	1600	290	77	3 kg 0.032 m3 1 szt.	pasuje do biurk BOD516, BOD616, BOC50
	SOD18	350,-	1800	290	77	3.5 kg 0.037 m3 1 szt.	pasuje do biurk BOD518, BOD618, BOC60
	SOD20	365,-	2000	290	77	4 kg 0.041 m3 1 szt.	pasuje do biurk BOD520, BOD620
		SG12	155,-	660	107	120	2 kg 0.018 m3 1 szt.
SG16		180,-	1160	107	120	3 kg 0.025 m3 1 szt.	do biurk pojedynczych o szerokości 1600 mm i 1800 mm
	SG220	165,-	1050	396	130	2 kg 0.081 m3 1 szt.	do benchy o szerokości 1200 i 1400 mm, z wyjątkiem Ogi Drive
	SG260	195,-	1450	396	130	2 kg 0.111 m3 1 szt.	do benchy o szerokości 1600 i 1800 mm, z wyjątkiem Ogi Drive i Ogi A
	PK80	34,-	80	80	23	0.1 kg 0 m3 1 szt.	przelot kablowy Ø 80 mm, 02 - szary, 08 - czarny, 67 - biały
	M07	505,-	80	80	80	1 kg 0.001 m3 1 szt.	mediabox, kolor: czarny, biały, montowany zamiast istniejącego przepustu kablowego Ø80mm (PK80); 1 gniazdo zasilające 230V + 1 x USB charger + 1 x RJ45

Dodatkowa dopłata							

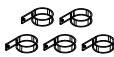
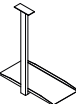
Akcesoria							
	Symbol	Cena netto PLN	Wymiary			Waga Obj. Opak.	Uwagi
			Szer.	Gł.	Wys.		
	M04	295,-	275	120	140	1.6 kg 0.008 m3 1 szt.	4x230V, 2xRJ45, 1xUSB
	M04H	315,-	275	120	140	2 kg 0.013 m3 2 szt.	4x230V, 2xRJ45, 1xUSB, 1xHDMI
	M05	105,-	275	120	25	0.3 kg 0.002 m3 1 szt.	top access
	E64	115,-	460	89	120	0.5 kg 0.001 m3 1 szt.	kanał kablowy, M009 - aluminium półmat
	S69	130,-	580	162	123	1 kg 0.015 m3 1 szt.	09 - aluminium
	S94	249,-	140	140	750	0.95 kg 0.004 m3 1 szt.	przewodzenie kabli (sprężyna), 09 - aluminium
	S95	105,-	470	42	34	0.35 kg 0.001 m3 1 szt.	pionowy organizer kablowy, pasuje do biurek Ogi Y, Ogi M oraz do nogi środkowej Ogi A o profilu 40mm
	S93	105,-	470	62	34	1 kg 0.002 m3 1 szt.	pionowy organizer kablowy, pasuje do biurek Ogi Drive, Yan, Ogi A, Ogi Q i Ogi U o profilu 60 mm
	S81	155,-	140	70	750	1.1 kg 0.008 m3 1 szt.	przewodzenie kabli (kręgosłup); kolor 09 - aluminium, do biurek bez regulacji wysokości
	S96	80,-	1370	28	2	0.3 kg 0.003 m3 1 szt.	tkaninowy organizer kablowy, pasuje do biurek Ogi, Ogi Drive

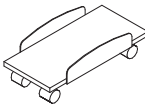
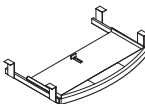
Dodatkowa dopłata							

Akcesoria							
	Symbol	Cena netto PLN	Wymiary			Waga Obj. Opak.	Uwagi
			Szer.	Gł.	Wys.		
	S82	80,-	1000	70	35	1 kg 0.005 m3 1 szt.	grzebień do mocowania kabli pod blatem, 09 - aluminium
	AK3	39,-	0	0	0	0.2 kg 0 m3 1 szt.	rzepy do mocowania kabli, 02-szary, 6 szt. (3 z wkrętami, 3 bez wkrętów);
	AK5	46,-	0	0	0	0.2 kg 0 m3 1 szt.	zaczepek do prowadzenia kabla, 08 - czarny, 5 szt.
	S83	225,-	212	460	605	2.596 kg 0.027 m3 1 szt.	zawieszka do komputera
	S89	275,-	116	460	549	3.5 kg 0.005 m3 1 szt.	pasuje do biurka Ogi Drive, Ogi W, Ogi M, Ogi Q, Ogi U oraz Ogi Y, z wyjątkiem Ogi A, Ogi N, Ogi V
	S73	179,-	220	470	148	2.9 kg 0.002 m3 1 szt.	wózek do komputera, 26 - aluminium satinato
	C01	149,-	610	400	85	1.3 kg 0.01 m3 1 szt.	półka pod klawiaturę do biurka o głębokości 800 mm, z wyjątkiem biurka Drive, 02 - szary
	S11	65,-	45	50	57	0.2 kg 0 m3 1 szt.	wieszak na torebkę, M015 - biały półmat

Dodatkowa dopłata							

Zestawienie kolorystyczne - Ergonomic Master

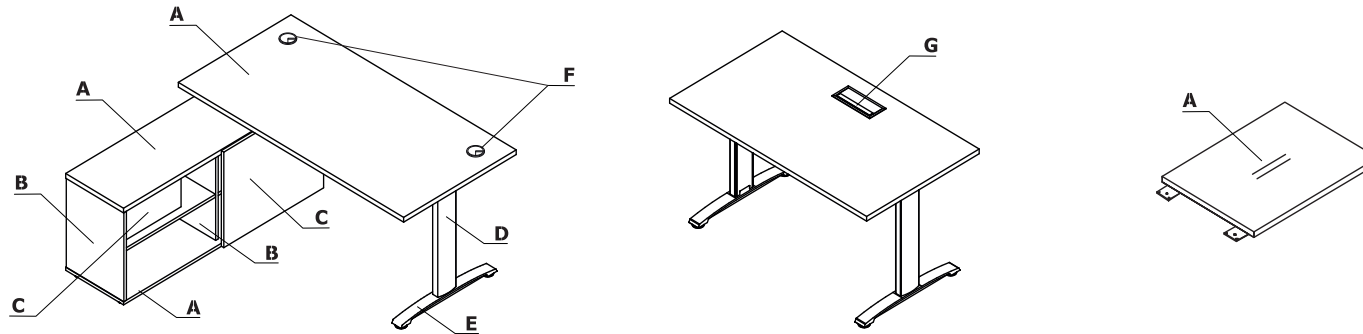

Materiał	Kolor	Biuurka						Akcesoria								
		A - Biał, wieniec górny i dolny	B - Korpus	C - Front	D - Stelaż	E - Stopa	F - Przepusty kablowe	G - Mediabox	E64, S69	S81, S82, S94	S83, S89, S93	S11				
Płyta	26 - aluminium satinato	✓	✓	✓			Aluminium									
	31 - dąb kanadyjski	✓	II grupa	✓			Beżowy									
	39 - brzoza polarna	✓	II grupa	✓			Beżowy									
	64 - kakao	✓	II grupa	✓			Beżowy									
	67 - biały pastel	✓	✓	✓			Biały									
	106 - orzech nizinny	✓	II grupa	✓			Czarny									
	08 - czarny	✓	✓	✓			Czarny									
	154 - antracyt	✓	✓	✓			Czarny									
	167 - dąb szary	✓	II grupa	✓			Czarny									
	168 - dąb naturalny	✓	II grupa	✓			Beżowy									
	169 - dąb miodowy	✓	II grupa	✓			Beżowy									
	170 - akacja	✓	II grupa	✓			Beżowy									
171 - orzech ciemny	✓	II grupa	✓			Czarny										
Metal	M009 - aluminium półmat RAL 9006				✓	✓		✓		✓						
	M015 - biały półmat RAL 9010				✓	✓		✓		✓	✓					
	M115 - czarny półmat RAL 9005				✓	✓		✓		✓						
	M154 - antracyt półmat RAL 7043				✓	✓		✓								
	25 - aluminium polerowane								✓*							
	Tworzywo - szary									✓						

* stopa - dopłata 92 zł za 1 szt., do ceny biurka 184zł (komplet 2szt.)

Blat

1 Blat - płyta melaminowana 28 mm, obrzeża ABS

OPCJE Z DOPLATĄ:

2 Przepust kablowy - 2 szt., Ø 80 mm

3 Mediabox M04H - 2xRJ45 (class E, cat. 6); + 1 x USB + 1 x HDMI + 4 x 230V, kolor mediaboxu dobiera się do kolorystyki stelaża

4 Mediabox M04 - 2xRJ45 (class E, cat. 6); + 1 x USB + 4 x 230V, kolor mediaboxu dobiera się do kolorystyki stelaża

5 Mediabox M07 - 1 x 230V + 1 x USB charger + 1 x RJ45, kolor: czarny, biały, montowany zamiast istniejącego przepustu kablowego Ø80 mm (PK80)

6 Top access M05 - kolor top access dobiera się do kolorystyki stelaża

7 Wycięcie pod mediabox - mediabox wybierany osobno

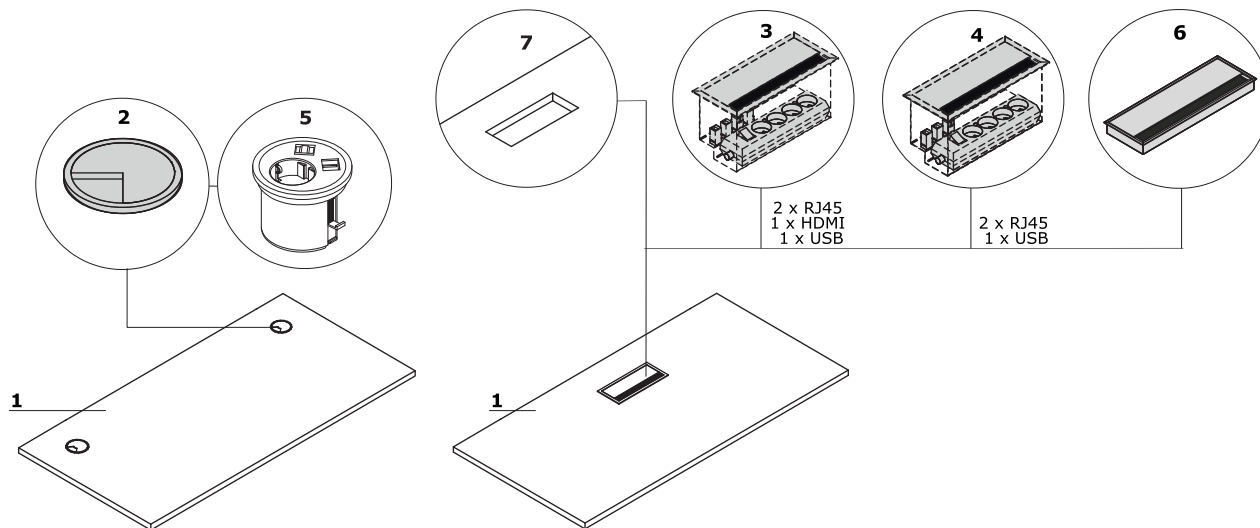
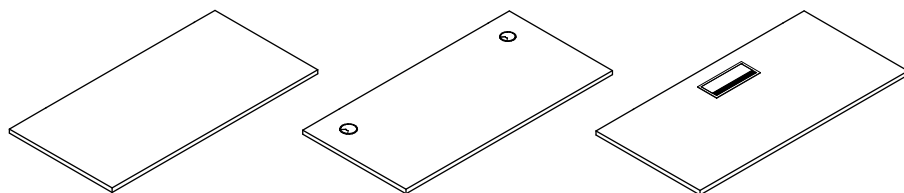
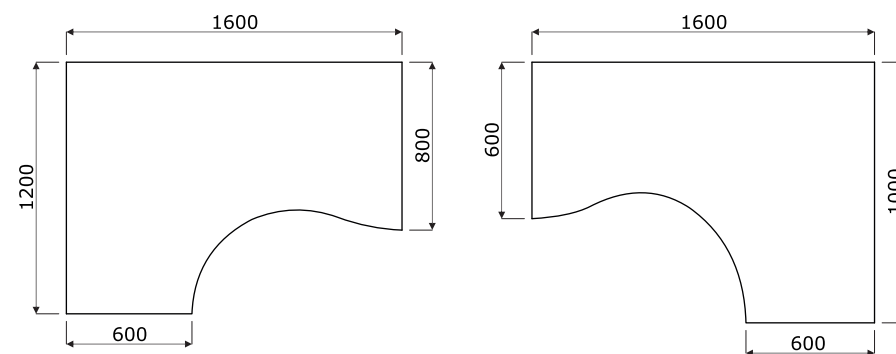
**Blat - konfiguracje****Wymiary blatów kształtowych (mm)**

Biurko z szafką managerską

- 1 **Błat** - płyta melaminowana 28 mm, obrzeża ABS
- 2 **Wieniec górny** - płyta melaminowana 28 mm, obrzeża ABS
- 3 **Boki** - płyta melaminowana 18 mm, obrzeża ABS
- 4 **Front przesuwny** - płyta melaminowana 18 mm, obrzeża ABS
- 5 **Półka** - płyta melaminowana 18 mm, zabezpieczenie przed przypadkowym wysunięciem, obrzeża ABS
- 6 **Wieniec dolny** - płyta melaminowana 18 mm, obrzeża ABS
- 7 **Szuflada** - płyta melaminowana 18 mm, obrzeża ABS, zamek patentowy - możliwość zmiany usytuowania

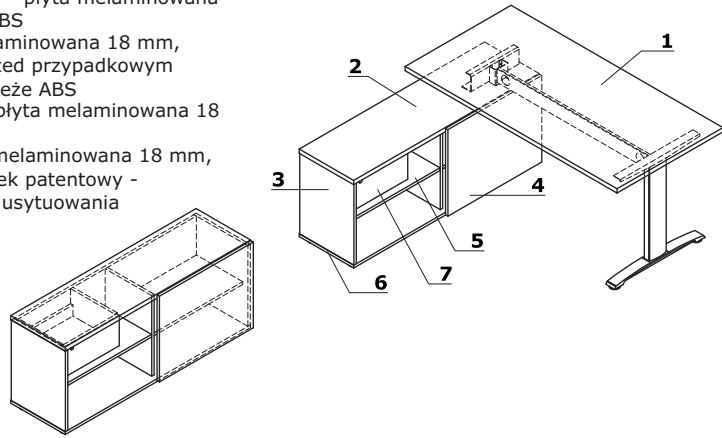

Akcesoria

- 1 **Szyna S69** - metal malowany proszkowo, kolor: 09-aluminium
- 2 **Szyna E64** - metal malowany proszkowo, kolor: M009 - aluminium półmat

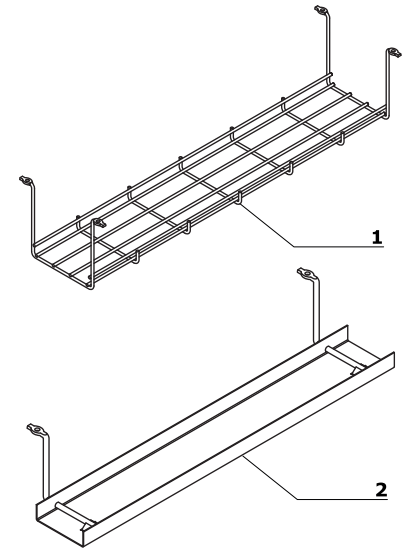

Przykładowe konfiguracje (mm)

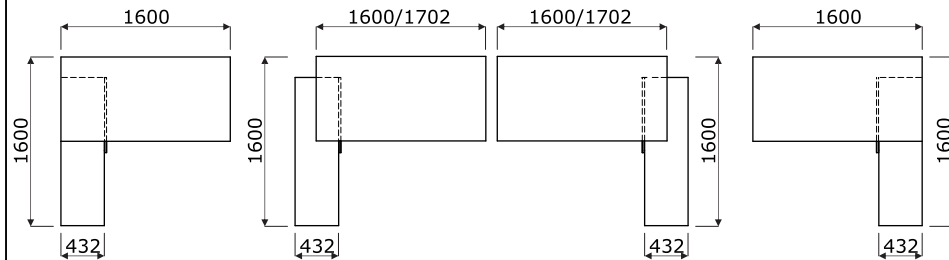

Stelaż

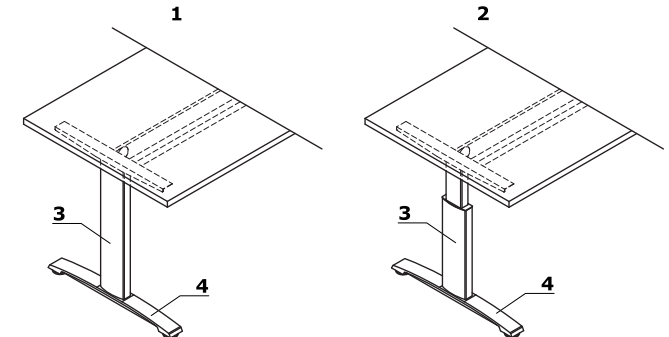

- 1 **Stelaż bez regulacji** - wysokość 740 mm
- 2 **Stelaż z regulacją manualną** - w zakresie 620-820 mm, skokowo co 20 mm
- 3 **Kolumna** - pionowe prowadzenie kablowe, malowane proszkowo
- 4 **Stopa** - malowana proszkowo; OPCJA Z DOPŁATĄ - aluminium polerowane

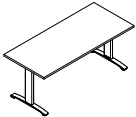
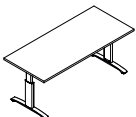

Uwaga - Szyna pod blatem zawsze w kolorze: M115 - czarny półmat

Biurka proste							
	Symbol	Cena netto PLN	Wymiary			Waga Obj. Opak.	Uwagi
			Szer.	Gł.	Wys.		
	BR01	1150,-	800	800	740	26.5 kg 0.046 m3 5 szt.	
	BR02	1190,-	1200	800	740	34.7 kg 0.06 m3 5 szt.	
	BR03	1230,-	1400	800	740	40.03 kg 0.067 m3 5 szt.	
	BR04	1270,-	1600	800	740	44.201 kg 0.08 m3 5 szt.	
	BR05	1370,-	1800	800	740	46.4 kg 0.082 m3 5 szt.	
	BR61	1130,-	800	600	740	24.1 kg 0.046 m3 6 szt.	
	BR63	1170,-	1200	600	740	30.75 kg 0.058 m3 6 szt.	
	BR64	1200,-	1400	600	740	32.38 kg 0.065 m3 6 szt.	
	BR65	1240,-	1600	600	740	35.251 kg 0.074 m3 6 szt.	
	Biurka z manualną regulacją wysokości						
	BR01R	1440,-	800	800	740	29.1 kg 0.053 m3 6 szt.	regulacja wysokości w zakresie 620-820mm, skokowo co 20mm
	BR02R	1490,-	1200	800	740	35.7 kg 0.06 m3 5 szt.	
	BR03R	1520,-	1400	800	740	41.03 kg 0.067 m3 5 szt.	
	BR04R	1560,-	1600	800	740	45.201 kg 0.08 m3 5 szt.	
	BR05R	1650,-	1800	800	740	47.4 kg 0.082 m3 5 szt.	
	BR61R	1390,-	800	600	740	25.1 kg 0.046 m3 6 szt.	

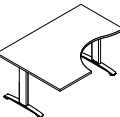
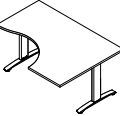
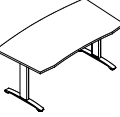
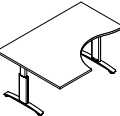
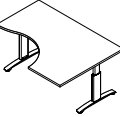





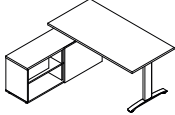

Dodatkowa dopłata							
Mediabox M04H	Mediabox M04	Top access	Przepusty kablowe	Wycięcie pod mediabox			
315,-	295,-	105,-	42,-	11,-			
315,-	295,-	105,-	42,-	11,-			
315,-	295,-	105,-	42,-	11,-			
315,-	295,-	105,-	42,-	11,-			
315,-	295,-	105,-	42,-	11,-			
315,-	295,-	105,-	42,-	11,-			
315,-	295,-	105,-	42,-	11,-			
315,-	295,-	105,-	42,-	11,-			
315,-	295,-	105,-	42,-	11,-			
315,-	295,-	105,-	42,-	11,-			
315,-	295,-	105,-	42,-	11,-			
315,-	295,-	105,-	42,-	11,-			
315,-	295,-	105,-	42,-	11,-			
315,-	295,-	105,-	42,-	11,-			

Biurka z manualną regulacją wysokości							
	Symbol	Cena netto PLN	Wymiary			Waga Obj. Opak.	Uwagi
			Szer.	Gł.	Wys.		
	BR63R	1420,-	1200	600	740	31.75 kg 0.058 m3 6 szt.	regulacja wysokości w zakresie 620-820mm, skokowo co 20mm
	BR64R	1460,-	1400	600	740	31.78 kg 0.057 m3 5 szt.	
	BR65R	1510,-	1600	600	740	34.651 kg 0.067 m3 5 szt.	
Biurka kształtowe							
	BR10	1410,-	1600	1200	740	46.901 kg 0.102 m3 5 szt.	należy zastosować odpowiednią nogę podpierającą
	BR66	1360,-	1600	1000	740	38.651 kg 0.089 m3 5 szt.	
	BR11	1410,-	1600	1200	740	48.301 kg 0.102 m3 5 szt.	
	BR67	1360,-	1600	1000	740	41.951 kg 0.09 m3 5 szt.	
	BR19	1610,-	1700	888	740	42.151 kg 0.086 m3 5 szt.	
Biurka kształtowe z manualną regulacją wysokości							
	BR10R	1690,-	1600	1200	740	47.901 kg 0.102 m3 5 szt.	regulacja wysokości w zakresie 620-820mm, skokowo co 20mm; należy zastosować odpowiednią nogę podpierającą
	BR66R	1630,-	1600	1000	740	39.651 kg 0.089 m3 5 szt.	
	BR11R	1690,-	1600	1200	740	49.301 kg 0.102 m3 5 szt.	
	BR67R	1630,-	1600	1000	740	42.951 kg 0.09 m3 5 szt.	
	BR19R	1920,-	1700	888	740	43.151 kg 0.086 m3 5 szt.	





Dodatkowa dopłata							
Mediabox M04H	Mediabox M04	Top access	Przepusty kablowe	Wycięcie pod mediabox			
315,-	295,-	105,-	42,-	11,-			
315,-	295,-	105,-	42,-	11,-			
315,-	295,-	105,-	42,-	11,-			
315,-	295,-	105,-	42,-	11,-			
315,-	295,-	105,-	42,-	11,-			
315,-	295,-	105,-	42,-	11,-			
315,-	295,-	105,-	42,-	11,-			
315,-	295,-	105,-	42,-	11,-			
315,-	295,-	105,-	42,-	11,-			
315,-	295,-	105,-	42,-	11,-			
315,-	295,-	105,-	42,-	11,-			
315,-	295,-	105,-	42,-	11,-			

Biuorka z szafką managerską							
	Symbol	Cena netto PLN	Wymiary			Waga Obj. Opak.	Uwagi
			Szer.	Gł.	Wys.		
	BRL16	2380,-	1702 1600	1600	740	106.83 kg 0.226 m3 12 szt.	uniwersalne (lewe / prawe);
	BRL18	2490,-	1902 1800	1600	740	107.651 kg 0.237 m3 12 szt.	

Dodatkowa dopłata							
Mediabox M04H	Mediabox M04	Top access	II grupa cenowa	Przepusty kablowe	Wycięcie pod mediabox		
315,-	295,-	105,-	80,-	42,-	11,-		
315,-	295,-	105,-	80,-	42,-	11,-		

Akcesoria							
	Symbol	Cena netto PLN	Wymiary			Waga Obj. Opak.	Uwagi
			Szer.	Gł.	Wys.		
	M07	505,-	80	80	80	1 kg 0.001 m3 1 szt.	mediabox, kolor: czarny, biały, montowany zamiast istniejącego przepustu kablowego Ø80mm (PK80); 1 gniazdo zasilające 230V + 1 x USB charger + 1 x RJ45
	PK80	34,-	80	80	23	0.1 kg 0 m3 1 szt.	przelot kablowy Ø 80 mm, 02 - szary, 08 - czarny, 67 - biały
	M04	295,-	275	120	140	1.6 kg 0.008 m3 1 szt.	4x230V, 2xRJ45, 1xUSB
	M04H	315,-	275	120	140	2 kg 0.013 m3 2 szt.	4x230V, 2xRJ45, 1xUSB, 1xHDMI
	M05	105,-	275	120	25	0.3 kg 0.002 m3 1 szt.	top access
	E64	115,-	460	89	120	0.5 kg 0.001 m3 1 szt.	kanał kablowy, M009 - aluminium półmat
	S69	130,-	580	162	123	1 kg 0.015 m3 1 szt.	09 - aluminium
	AK5	46,-	0	0	0	0.2 kg 0 m3 1 szt.	zaczep do prowadzenia kabla, 08 - czarny, 5 szt.
	AK3	39,-	0	0	0	0.2 kg 0 m3 1 szt.	rzepy do mocowania kabli, 02-szary, 6 szt. (3 z wkrętami, 3 bez wkrętów);

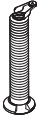
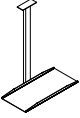
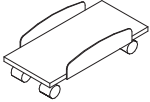
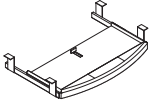
Dodatkowa dopłata							

Akcesoria							
	Symbol	Cena netto PLN	Wymiary			Waga Obj. Opak.	Uwagi
			Szer.	Gł.	Wys.		
	S82	80,-	1000	70	35	1 kg 0.005 m3 1 szt.	grzebień do mocowania kabli pod blatem, 09 - aluminium
	S81	155,-	140	70	750	1.1 kg 0.008 m3 1 szt.	przewodzenie kabli (kręgosłup); kolor 09 - aluminium, do biurek bez regulacji wysokości
	S94	249,-	140	140	750	0.95 kg 0.004 m3 1 szt.	przewodzenie kabli (sprężyna), 09 - aluminium
	S83	225,-	212	460	605	2.596 kg 0.027 m3 1 szt.	zawiesie do komputera
	S73	179,-	220	470	148	2.9 kg 0.002 m3 1 szt.	wózek do komputera, 26 - aluminium satynato
	C01	149,-	610	400	85	1.3 kg 0.01 m3 1 szt.	półka pod klawiaturę do biurek o głębokości 800 mm, z wyjątkiem biurek Drive, 02 - szary
	S11	65,-	45	50	57	0.2 kg 0 m3 1 szt.	wieszak na torebkę, M015 - biały półmat

Dodatkowa dopłata

Zestawienie kolorystyczne - Przystawki

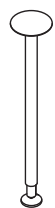
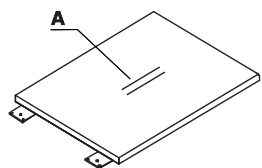

N45



NE41

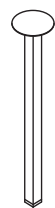

NG41



NS10

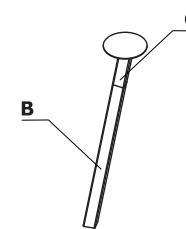

NS10W

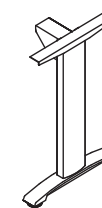

NE50

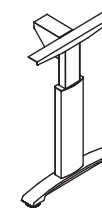

NE50R





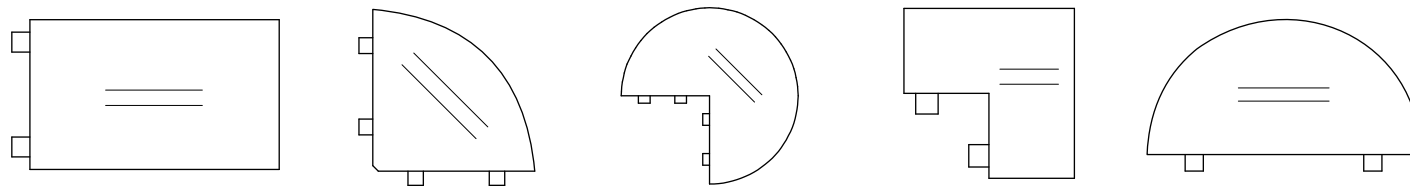

Materiał	Kolor	Przystawki do blurek			Nogi podpierające		NS10W									
		A - Blat	N45, NE41, NG41, NS10	Kolumna - NE50, NE50R	Stopa - NE50, NE50R	B - Noga	C - Stelaz									
Płyta	26 - aluminium satynato	✓														
	31 - dąb kanadyjski	✓														
	39 - brzoza polarna	✓														
	64 - kakao	✓														
	67 - biały pastel	✓														
	106 - orzech nizinny	✓														
	154 - antracyt	✓														
	08 - czarny	✓														
	167 - dąb szary	✓														
	168 - dąb naturalny	✓														
	169 - dąb miodowy	✓														
	170 - akacja	✓														
	171 - orzech ciemny	✓														
Metal	M009 - aluminium półmat RAL 9006		✓	✓	✓		✓									
	M115 - czarny półmat RAL 9005		✓	✓	✓		✓									
	M015 - biały półmat RAL 9010		✓				✓									
	M154 - antracyt półmat RAL 7043		✓				✓									
	25 - aluminium polerowane					✓*										
	Sklejka - jasny jesion						✓									

* stopa dopłata 92 zł za stopę (1 szt.)

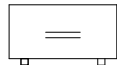



Przystawki do biurka





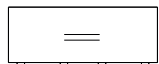
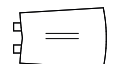

UWAGI: 1. Blaty - płyta melaminowana 28 mm; 2. Należy domówić odpowiednie nogi podpierające.

Przystawki do biur							
	Symbol	Cena netto PLN	Wymiary			Waga Obj. Opak.	Uwagi
			Szer.	Gł.	Wys.		
	PL02	230,-	800	600	28	10.9 kg 0.019 m3 3 szt.	w cenę nie wliczono nóg podpierających (2szt.);
	PL11	275,-	1000	600	28	13.4 kg 0.023 m3 3 szt.	w cenę nie wliczono nóg podpierających (2szt.);
	PL12	315,-	1200	600	28	16.35 kg 0.027 m3 3 szt.	w cenę nie wliczono nóg podpierających (2szt.);
	PL16	405,-	1600	600	28	20.6 kg 0.036 m3 5 szt.	w cenę nie wliczono nóg podpierających (2szt.);
	PL04	390,-	828	828	28	13.9 kg 0.026 m3 1 szt.	w cenę nie wliczono nóg podpierających (1szt.);
	PL27	590,-	1200	1200	28	19.5 kg 0.052 m3 1 szt.	w cenę nie wliczono nóg podpierających (2szt.);
	PL37	515,-	600	600	28	6.25 kg 0.015 m3 1 szt.	w cenę nie wliczono nóg podpierających (1szt.);
	PL21	480,-	1200	600	28	13.9 kg 0.028 m3 1 szt.	w cenę nie wliczono nóg podpierających (1szt.);
	PL20	455,-	516	1600	28	16 kg 0.032 m3 1 szt.	w cenę nie wliczono nóg podpierających (1szt.);
	PL07	260,-	400	800	28	6.95 kg 0.014 m3 1 szt.	w cenę nie wliczono nóg podpierających (1szt.);



Dodatkowa dopłata

Przystawki do układu dwóch biurek							
	Symbol	Cena netto PLN	Wymiary			Waga Obj. Opak.	Uwagi
			Szer.	Gł.	Wys.		
	PL06	505,-	1210	600	28	12.85 kg 0.028 m3 1 szt.	do układu dwóch biurek Ogi
	PL32	365,-	516	1410	28	12.7 kg 0.039 m3 1 szt.	w cenę nie wliczono nóg podpierających (1szt.);
	PL23	455,-	516	1610	28	15.05 kg 0.033 m3 1 szt.	w cenę nie wliczono nóg podpierających (1szt.);
	PL26	410,-	1610	600	28	21.3 kg 0.036 m3 5 szt.	w cenę nie wliczono nóg podpierających (2szt.);
Przystawka do biurka kształtowego BR19							
	PL43	410,-	500 600	860	28	10.1 kg 0.021 m3 1 szt.	w cenę nie wliczono nóg podpierających (2szt.);
Formatki do tworzenia stołów							
	PL17	220,-	800	600	28	10.5 kg 0.019 m3 1 szt.	w cenę nie wliczono nóg podpierających i płaskowników
	PL18	310,-	1200	600	28	15.95 kg 0.027 m3 1 szt.	w cenę nie wliczono nóg podpierających i płaskowników
	PL19	400,-	1600	600	28	19.8 kg 0.036 m3 1 szt.	w cenę nie wliczono nóg podpierających i płaskowników
Nogi podpierające							
	N45	155,-	40	40	712	1.5 kg 0.002 m3 1 szt.	noga prosta regulowana ze stopką (685-785);

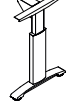
Dodatkowa dopłata							

Nogi podpierające							
	Symbol	Cena netto PLN	Wymiary			Waga Obj. Opak.	Uwagi
			Szer.	Gł.	Wys.		
	NE41	125,-	40	40	712	1.5 kg 0.002 m3 1 szt.	noga okrągła
	NG41	125,-	40	40	712	2 kg 0.002 m3 1 szt.	noga kwadratowa
	NS10	120,-	60	30	712	2 kg 0.002 m3 1 szt.	
	NS10W	270,-	40	40	712	1.7 kg 0.002 m3 1 szt.	
	NE50	520,-	500	45	712	6.1 kg 0.01 m3 4 szt.	noga podpierająca Ergonomic Master do biurek kształtowych, kolorystyka jak w nogach Ergonomic Mater
	NE50R	630,-	500	45	792	6.1 kg 0.01 m3 4 szt.	noga podpierająca Ergonomic Master do biurek kształtowych z regulacją wysokości w zakresie 620-820 mm, kolorystyka jak w nogach Ergonomic Mater

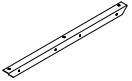
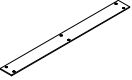
Dodatkowa dopłata

Elementy mocujące							
	Symbol	Cena netto PLN	Wymiary			Waga Obj. Opak.	Uwagi
			Szer.	Gł.	Wys.		
	E31	65,-	620	30	30	0.62 kg 0.001 m ³ 1 szt.	kątownik do krawędzi 800 mm
	E32	49,-	450	30	30	0.45 kg 0 m ³ 1 szt.	kątownik do krawędzi 600 mm
	E37	41,-	330	30	30	1.5 kg 0 m ³ 1 szt.	kątownik
	E33	65,-	620	60	3	1 kg 0.003 m ³ 1 szt.	płaskownik do krawędzi 800 mm
	E34	49,-	450	60	3	0.7 kg 0 m ³ 1 szt.	płaskownik do krawędzi 600 mm
	E38	41,-	330	60	3	0.5 kg 0 m ³ 1 szt.	płaskownik
	E40	97,-	145	80	3	0.4 kg 0 m ³ 2 szt.	płaskownik, 2 szt.

Dodatkowa dopłata

Zestawienie kolorystyczne - Panele

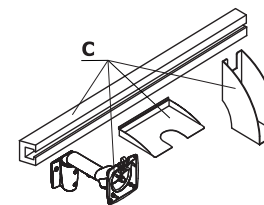
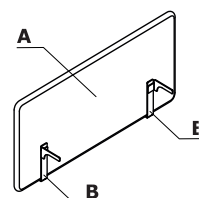
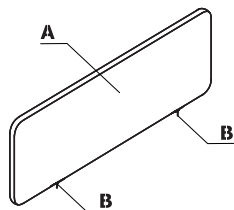
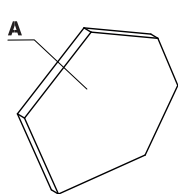

Materiał	Kolor	Panele tkaninowe															
		A - Twin	A - Sonic	B - Uchwyt	C - Akcesoria												
Tkanina	Nemo	✓	✓														
	Runner	II grupa	II grupa														
	Medley	II grupa	II grupa														
	**Atlantic	II grupa	II grupa														
	Vita	II grupa	II grupa														
	Mica	II grupa	II grupa														
	Go Check	II grupa	II grupa														
	Charles	II grupa	II grupa														
	Xtreme	III grupa	III grupa														
	Synergy	III grupa	III grupa														
	***Silvertex	III grupa	III grupa														
	*Tkanina powierzona	II grupa	II grupa														
	Atlas	IV grupa	IV grupa														
	Field2	IV grupa	IV grupa														
Metal	M009 - aluminium półmat RAL 9006			✓	✓												
	M015 - biały półmat RAL 9010			✓													
	M154 - antracyt półmat RAL 7043			✓													
	M115 - czarny półmat RAL 9005			✓													

* Zastosowanie tkaniny powierzonej wymaga przeprowadzenia prób tapicerskich, w celu sprawdzenia możliwości wykonawczych

*** Istnieje możliwość zamówienia produktu w pełnej kolorystyce Silvertex wg wzornika Spradling w terminie nie krótszym niż 15 dni roboczych

** Istnieje możliwość zamówienia produktu w pełnej kolorystyce Atlantic wg wzornika Gabriel w terminie nie krótszym niż 7 dni roboczych

Panele

- 1 Panel Sonic** - tapicerowany, klasa akustyczności "A", możliwość wpinania szpilek
- 2 Zamek błyskawiczny** - ozdobny, bez możliwości odpinania, kolor: grafit
- 3 Rama** - konstrukcja z litego drewna klejonego
- 4 Wypełnienie** - włóknina akustyczna o wysokim stopniu pochłaniania i rozpraszania dźwięków
- 5 Wspornik stalowy** - osadzony w ramie, z gwintem maszynowym do stabilnego mocowania uchwytów paneli (dotyczy paneli naburkanych)
- 6 Panel Twin** - tapicerowany, możliwość wpinania szpilek, pasek tworzywowy
- 7 Element dekoracyjny** - pasek tworzywowy, kolor: szary
- 8 Konstrukcja** - płyta wiórowa pokryta obustronnie pianką poliuretanową
- 9 Yan** - uchwyt do biurek pojedynczych (OPCJA Z DOPŁATĄ); metal malowany proszkowo
- 10 Yan** - uchwyt do biurek typu bench w komplecie; metal malowany proszkowo
- 11 Ogi, Ergonomic Master** - uchwyt do biurek pojedynczych (OPCJA Z DOPŁATĄ); przystosowany do montażu do blatów o grubości 16-30 mm
- 12 Ogi** - uchwyt do biurek typu bench w komplecie; metal malowany proszkowo; przystosowany do montażu do blatów o grubości 16-30 mm

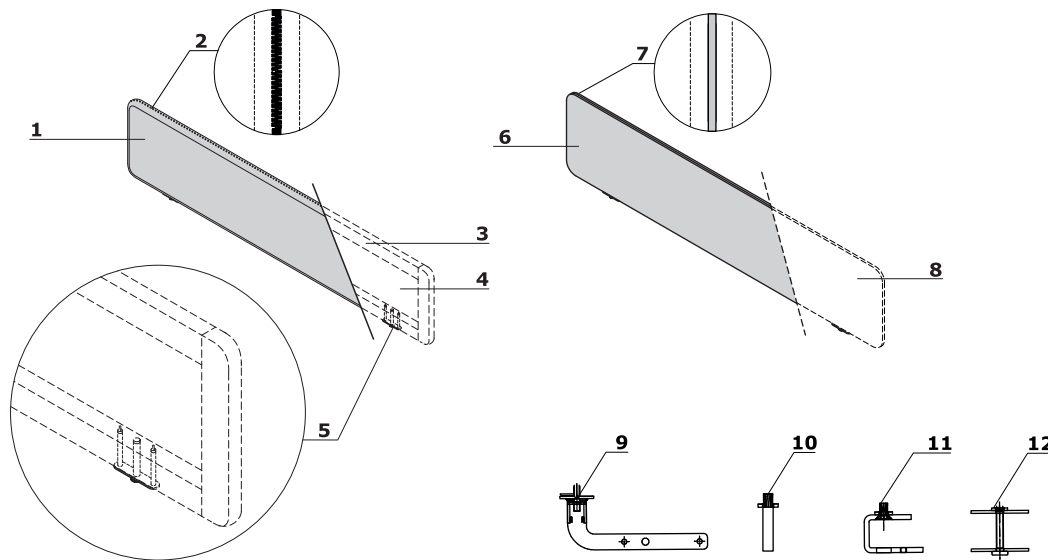

Twin, Sonic - panele boczne (mm)

- 1 Panel boczny:**
 - Twin - możliwość wpinania szpilek
 - Sonic - klasa akustyczności „A”, możliwość wpinania szpilek
- 2 Mocowanie paneli bocznych** - metal malowany proszkowo, kolor: M009 - aluminium **1** półmat

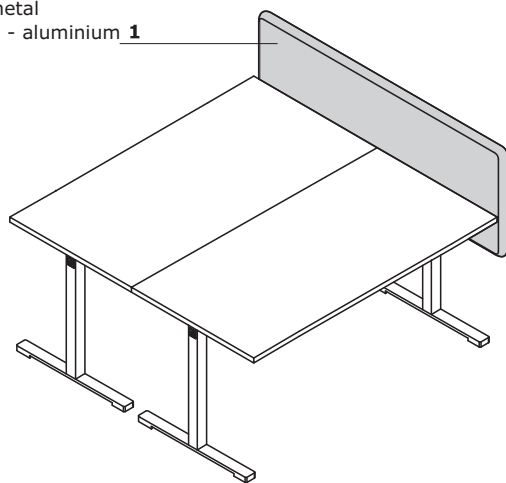

TWIN

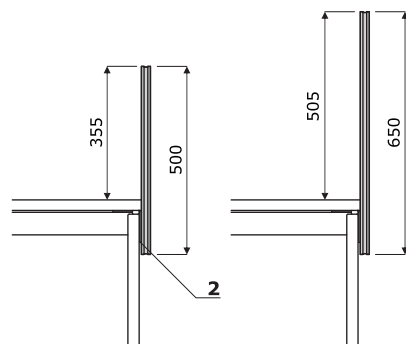

SONIC

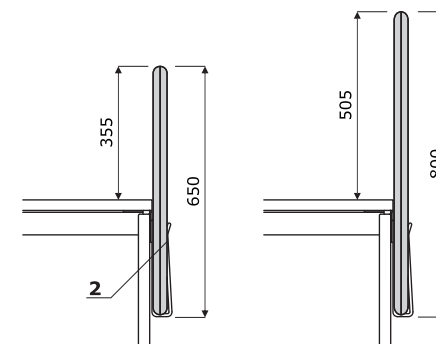

Twin, Sonic - panele poprzeczne do bench-y

- 1 Panel Twin** - tapicerowany, możliwość wpinania szpilek, pasek tworzywow
- 2 Panel Sonic** - klasa akustyczności A, możliwość wpinania szpilek, zamek błyskawiczny ozdobny - kolor: grafit - brak możliwości odpinania
- 3 Mocowanie paneli poprzecznych do biurek Ogi** - stopa 2 szt.
- 4 Mocowanie paneli poprzecznych do biurek Yan** - listwa wpuszczana między blaty

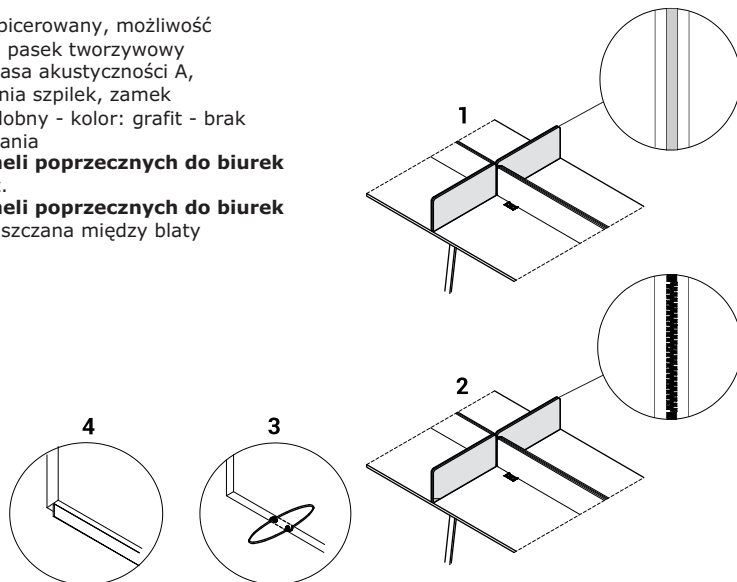

Twin - panele tkaninowe do benchy

- 1 Tkanina** - możliwość przypinania szpilek
- 2 Mocowanie** - metal malowany proszkowo, kolor: M009 - aluminium półmat
- 3 Profil mocujący** - metal malowany proszkowo, kolor: M009 - aluminium półmat

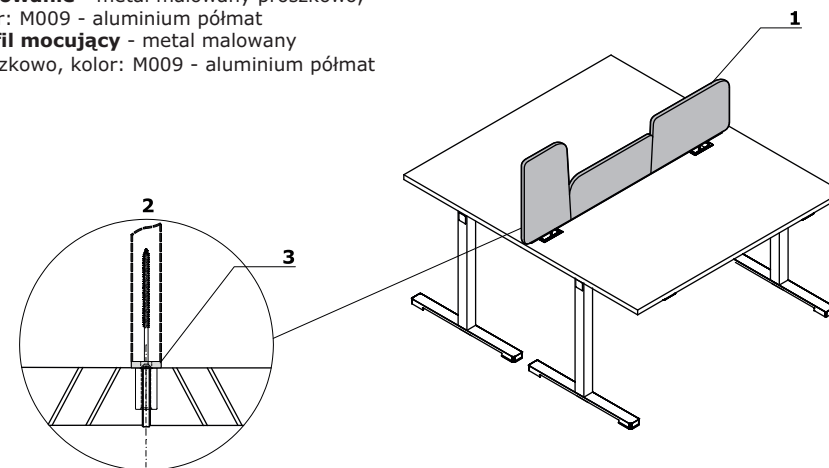

Sonic - dodatki do listwy funkcyjnej

- 1 Listwa funkcyjna** - max obciążenie: 3,5 kg na punkt, 7 kg na stronę (panel może wytrzymać maksymalne obciążenie 14 kg rozłożone równomiernie z każdej strony)
- 2 Uchwyt na monitor** - metal malowany proszkowo, kolor: M009 - aluminium półmat
- 3 Piórnik** - metal malowany proszkowo
- 4 Półka** - format A4, metal malowany proszkowo
- 5 Organizator** - metal malowany proszkowo

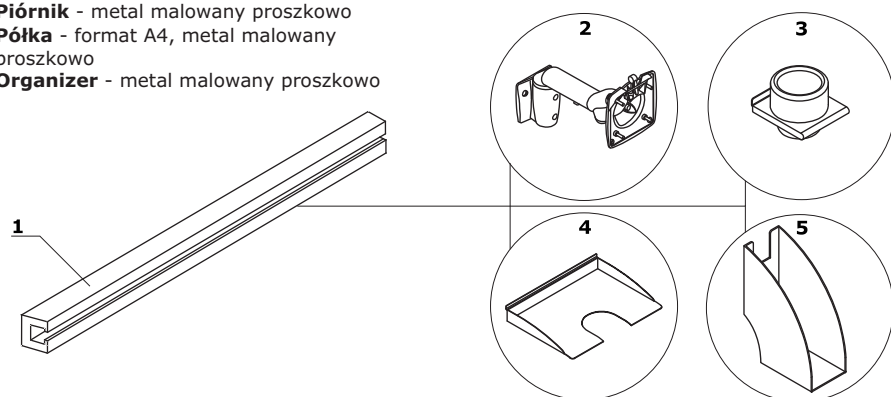

UWAGA: Możliwość mocowania akcesoriów wyłącznie z oferty MDD

Panele Sonic do biurek pojedynczych (mm)

- 1 Tkanina** - klasa akustyczności "A", możliwość wpinania szpilek
- 2 Mocowanie** - metal malowany proszkowo
- 3 Zamek błyskawiczny** - ozdobny, bez możliwości odpinania, kolor: grafit

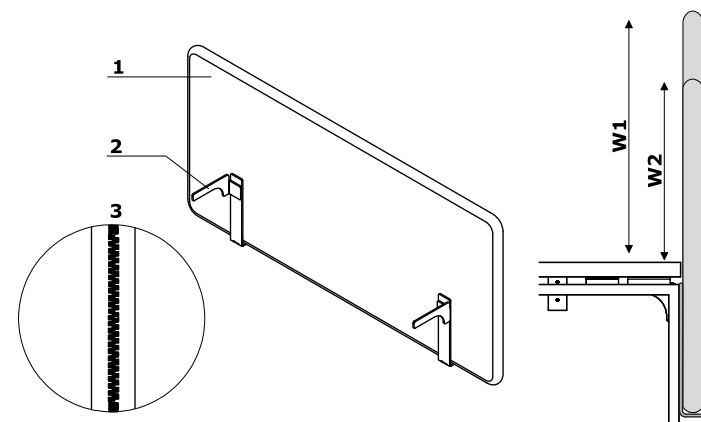

Uchwyt do Ogi Drive - wymiary (mm)

1 Uchwyt Ogi Drive - opcja z dopłatą;
 mocowany do stelaża; metal malowany
 proszkowo, profil 60x60 mm

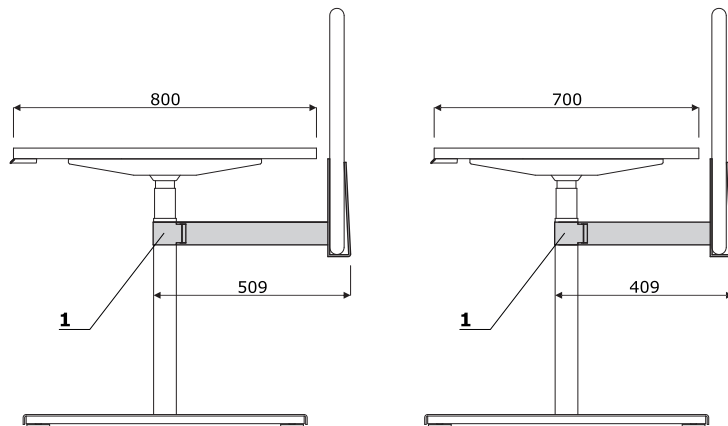

Uwaga - przy zakupie uchwytu Ogi Drive, mocowanego do stelaża - brak
 możliwości montażu listwy funkcyjnej

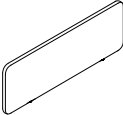
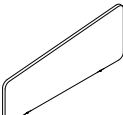
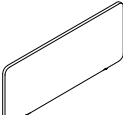
Twin - panele tkaninowe							
	Symbol	Cena netto PLN	Wymiary			Waga Obj. Opak.	Uwagi
			Szer.	Gł.	Wys.		
	ZUT12	315,-	1190	30	350	7.7 kg 0.019 m3 2 szt.	do biurek o szer. 1200 mm; w systemie Yan wyłącznie do biurek z przepustami kablowymi; Uwaga: możliwość mocowania do pojedynczego biurka, w opcji z dopłatą
	ZUT14	335,-	1390	30	350	8.8 kg 0.021 m3 2 szt.	do biurek o szer. 1400 mm; w systemie Yan wyłącznie do biurek z przepustami kablowymi; Uwaga: możliwość mocowania do pojedynczego biurka, w opcji z dopłatą
	ZUT16	350,-	1590	30	350	10.1 kg 0.024 m3 2 szt.	do biurek o szer. 1600 mm; w systemie Yan wyłącznie do biurek z przepustami kablowymi; Uwaga: możliwość mocowania do pojedynczego biurka, w opcji z dopłatą
	ZUT18	370,-	1790	30	350	10.9 kg 0.027 m3 2 szt.	do biurek o szer. 1800 mm; w systemie Yan wyłącznie do biurek z przepustami kablowymi; Uwaga: możliwość mocowania do pojedynczego biurka, w opcji z dopłatą
	ZUT20	395,-	1990	30	350	11.9 kg 0.029 m3 2 szt.	do biurek o szer. 2000 mm; w systemie Yan wyłącznie do biurek z przepustami kablowymi; Uwaga: możliwość mocowania do pojedynczego biurka, w opcji z dopłatą
		ZUT22	405,-	1190	30	350 450	10 kg 0.021 m3 2 szt.
ZUT24		430,-	1390	30	350 450	11 kg 0.025 m3 2 szt.	do biurek o szer. 1400 mm; w systemie Yan wyłącznie do biurek z przepustami kablowymi; Uwaga: możliwość mocowania do pojedynczego biurka, w opcji z dopłatą, panel asymetryczny
ZUT26		450,-	1590	30	350 450	12 kg 0.028 m3 2 szt.	do biurek o szer. 1600 mm; w systemie Yan wyłącznie do biurek z przepustami kablowymi; Uwaga: możliwość mocowania do pojedynczego biurka, w opcji z dopłatą, panel asymetryczny
ZUT28		475,-	1790	30	350 450	13 kg 0.035 m3 2 szt.	do biurek o szer. 1800 mm; w systemie Yan wyłącznie do biurek z przepustami kablowymi; Uwaga: możliwość mocowania do pojedynczego biurka, w opcji z dopłatą, panel asymetryczny
ZUT29		500,-	1990	30	350 450	14 kg 0.039 m3 2 szt.	do biurek o szer. 2000 mm; w systemie Yan wyłącznie do biurek z przepustami kablowymi; Uwaga: możliwość mocowania do pojedynczego biurka, w opcji z dopłatą, panel asymetryczny
	ZUT52	405,-	1190	30	500	10.2 kg 0.024 m3 2 szt.	do biurek o szer. 1200 mm; w systemie Yan wyłącznie do biurek z przepustami kablowymi; Uwaga: możliwość mocowania do pojedynczego biurka, w opcji z dopłatą
	ZUT54	440,-	1390	30	500	12 kg 0.028 m3 2 szt.	do biurek o szer. 1400mm; w systemie Yan wyłącznie do biurek z przepustami kablowymi; Uwaga: możliwość mocowania do pojedynczego biurka, w opcji z dopłatą
	ZUT56	475,-	1590	30	500	13.4 kg 0.031 m3 2 szt.	do biurek o szer. 1600mm; w systemie Yan wyłącznie do biurek z przepustami kablowymi; Uwaga: możliwość mocowania do pojedynczego biurka, w opcji z dopłatą
	ZUT58	510,-	1790	30	500	15.3 kg 0.035 m3 2 szt.	do biurek o szer. 1800mm; w systemie Yan wyłącznie do biurek z przepustami kablowymi; Uwaga: możliwość mocowania do pojedynczego biurka, w opcji z dopłatą
	ZUT59	540,-	1990	30	500	15.5 kg 0.039 m3 2 szt.	do biurek o szer. 2000mm; w systemie Yan wyłącznie do biurek z przepustami kablowymi; Uwaga: możliwość mocowania do pojedynczego biurka, w opcji z dopłatą

Dodatkowa dopłata						
II grupa cenowa	III grupa cenowa	Uchwyt do pojedynczego biurka	Listwa na akcesoria x1	Listwa na akcesoria x2	IV grupa cenowa	
120,-	280,-	65,-	135,-	250,-	400,-	
140,-	330,-	65,-	135,-	250,-	470,-	
160,-	380,-	65,-	135,-	250,-	540,-	
180,-	420,-	65,-	135,-	250,-	600,-	
200,-	470,-	65,-	135,-	250,-	670,-	
120,-	280,-	65,-	135,-	250,-	400,-	
140,-	330,-	65,-	135,-	250,-	470,-	
160,-	380,-	65,-	135,-	250,-	540,-	
180,-	420,-	65,-	135,-	250,-	600,-	
200,-	470,-	65,-	135,-	250,-	670,-	
120,-	280,-	65,-	135,-	250,-	400,-	
140,-	330,-	65,-	135,-	250,-	470,-	
160,-	380,-	65,-	135,-	250,-	540,-	
180,-	420,-	65,-	135,-	250,-	600,-	
200,-	470,-	65,-	135,-	250,-	670,-	

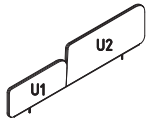
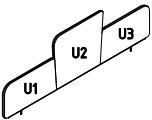
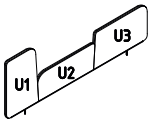
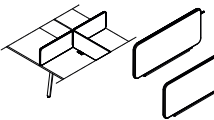
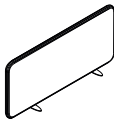
Twinn - panele tkaninowe do benchy							
	Symbol	Cena netto PLN	Wymiary			Waga Obj. Opak.	Uwagi
			Szer.	Gł.	Wys.		
	ZUT32	525,-	1190	30	360	7 kg 0.024 m3 1 szt.	do benchy o szer. 1200 mm; w systemie Yan wyłącznie do biurek z przepustami kablowymi
	ZUT34	570,-	1390	30	360	7.5 kg 0.018 m3 1 szt.	do benchy o szer. 1400 mm; w systemie Yan wyłącznie do biurek z przepustami kablowymi
	ZUT36	700,-	1590	30	560	11.8 kg 0.033 m3 1 szt.	do benchy o szer. 1600 mm; w systemie Yan wyłącznie do biurek z przepustami kablowymi
	ZUT38	800,-	1790	30	560	13 kg 0.037 m3 1 szt.	do benchy o szer. 1800 mm; w systemie Yan wyłącznie do biurek z przepustami kablowymi
	ZUT46	700,-	1590	30	560	10 kg 0.033 m3 1 szt.	do benchy o szer. 1600 mm; w systemie Yan wyłącznie do biurek z przepustami kablowymi
	ZUT48	800,-	1790	30	560	11.1 kg 0.037 m3 1 szt.	do benchy o szer. 1800 mm; w systemie Yan wyłącznie do biurek z przepustami kablowymi
Twinn - panele tkaninowe poprzeczne							
	ZYT78	520,-	1600	30	350	12 kg 0.014 m3 2 szt.	do benchy Yan (kpl. 2 szt.);
	ZYT79	780,-	1600	30	500	12 kg 0.021 m3 2 szt.	
	ZOT58	285,-	577	30	350	3.3 kg 0.005 m3 1 szt.	do benchy Ogi (1 szt.);
	ZOT68	295,-	677	30	350	4 kg 0.006 m3 1 szt.	
	ZOT78	300,-	777	30	350	4.4 kg 0.007 m3 1 szt.	
	ZOT10	415,-	577	30	500	4.1 kg 0.008 m3 1 szt.	
	ZOT40	425,-	677	30	500	5.4 kg 0.009 m3 1 szt.	
	ZOT79	430,-	777	30	500	6.1 kg 0.01 m3 1 szt.	

Dodatkowa dopłata						
II grupa cenowa	III grupa cenowa	IV grupa cenowa				
120,-	290,-	420,-				
140,-	340,-	480,-				
170,-	410,-	590,-				
190,-	460,-	650,-				
170,-	410,-	590,-				
190,-	460,-	650,-				
160,-	390,-	560,-				
160,-	390,-	560,-				
60,-	140,-	200,-				
75,-	170,-	240,-				
80,-	190,-	270,-				
60,-	140,-	200,-				
75,-	170,-	240,-				
80,-	190,-	270,-				

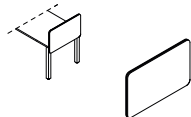
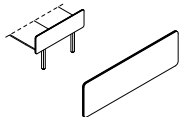
Twin - panele boczne do biurk pojedynczych							
	Symbol	Cena netto PLN	Wymiary			Waga Obj. Opak.	Uwagi
			Szer.	Gł.	Wys.		
	ZUT80	445,-	600	30	500	6 kg 0.011 m3 2 szt.	wysokość panela liczona od poziomu blatu wynosi 350 mm
	ZUT90	455,-	700	30	500	6.4 kg 0.013 m3 2 szt.	
	ZUT30	465,-	800	30	500	7.2 kg 0.014 m3 2 szt.	
	ZUT60	480,-	600	30	650	7.5 kg 0.014 m3 2 szt.	wysokość panela liczona od poziomu blatu wynosi 500 mm
	ZUT70	490,-	700	30	650	8 kg 0.016 m3 2 szt.	
	ZUT50	500,-	800	30	650	8.5 kg 0.018 m3 2 szt.	
	Twin - panele boczne do biurk typu bench						
	ZUT11	605,-	1200	30	500	10 kg 0.02 m3 2 szt.	wysokość panela liczona od poziomu blatu wynosi 350 mm
	ZUT41	615,-	1400	30	500	11.5 kg 0.023 m3 2 szt.	
	ZUT31	620,-	1600	30	500	13.3 kg 0.026 m3 2 szt.	
	ZUT61	675,-	1200	30	650	12.5 kg 0.025 m3 2 szt.	wysokość panela liczona od poziomu blatu wynosi 500 mm
	ZUT71	690,-	1400	30	650	14.5 kg 0.029 m3 2 szt.	
	ZUT51	695,-	1600	30	650	15 kg 0.033 m3 2 szt.	

Dodatkowa dopłata							
II grupa cenowa	III grupa cenowa	IV grupa cenowa					
65,-	150,-	210,-					
70,-	170,-	240,-					
80,-	190,-	280,-					
65,-	150,-	210,-					
70,-	170,-	240,-					
80,-	190,-	280,-					
120,-	290,-	410,-					
140,-	330,-	470,-					
160,-	380,-	540,-					
120,-	290,-	410,-					
140,-	330,-	470,-					
160,-	380,-	540,-					

Sonic - panele akustyczne						
Symbol	Cena netto PLN	Wymiary			Waga Obj. Opak.	Uwagi
		Szer.	Gł.	Wys.		
ZUS12	580,-	1190	40	350	5.3 kg 0.024 m3 2 szt.	do biurek o szer. 1200mm; w systemie Yan wyłącznie do biurek z przepustami kablowymi; Uwaga: możliwość mocowania do pojedynczego biurka, w opcji z dopłatą
ZUS14	615,-	1390	40	350	5.9 kg 0.028 m3 2 szt.	do biurek o szer. 1400 mm; w systemie Yan wyłącznie do biurek z przepustami kablowymi; Uwaga: możliwość mocowania do pojedynczego biurka, w opcji z dopłatą
ZUS16	650,-	1590	40	350	6.6 kg 0.032 m3 2 szt.	do biurek o szer. 1600mm; w systemie Yan wyłącznie do biurek z przepustami kablowymi; Uwaga: możliwość mocowania do pojedynczego biurka, w opcji z dopłatą
ZUS18	690,-	1790	40	350	7.2 kg 0.035 m3 2 szt.	do biurek o szer. 1800mm; w systemie Yan wyłącznie do biurek z przepustami kablowymi; Uwaga: możliwość mocowania do pojedynczego biurka, w opcji z dopłatą
ZUS20	735,-	1990	40	350	7.4 kg 0.039 m3 2 szt.	do biurek o szer. 2000mm; w systemie Yan wyłącznie do biurek z przepustami kablowymi; Uwaga: możliwość mocowania do pojedynczego biurka, w opcji z dopłatą
ZUS52	825,-	1190	40	500	5.8 kg 0.033 m3 2 szt.	do biurek o szer. 1200mm; w systemie Yan wyłącznie do biurek z przepustami kablowymi; Uwaga: możliwość mocowania do pojedynczego biurka, w opcji z dopłatą
ZUS54	870,-	1390	40	500	6.6 kg 0.039 m3 2 szt.	do biurek o szer. 1400mm; w systemie Yan wyłącznie do biurek z przepustami kablowymi; Uwaga: możliwość mocowania do pojedynczego biurka, w opcji z dopłatą
ZUS56	915,-	1590	40	500	7.3 kg 0.047 m3 2 szt.	do biurek o szer. 1600mm; w systemie Yan wyłącznie do biurek z przepustami kablowymi; Uwaga: możliwość mocowania do pojedynczego biurka, w opcji z dopłatą
ZUS58	960,-	1790	40	500	7.6 kg 0.049 m3 2 szt.	do biurek o szer. 1800mm; w systemie Yan wyłącznie do biurek z przepustami kablowymi; Uwaga: możliwość mocowania do pojedynczego biurka, w opcji z dopłatą
ZUS59	1005,-	1990	40	500	14 kg 0.054 m3 2 szt.	do biurek o szer. 2000mm; w systemie Yan wyłącznie do biurek z przepustami kablowymi; Uwaga: możliwość mocowania do pojedynczego biurka, w opcji z dopłatą

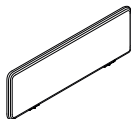

Dodatkowa dopłata						
II grupa cenowa	III grupa cenowa	Uchwyt do pojedynczego biurka	Listwa na akcesoria x1	Listwa na akcesoria x2	IV grupa cenowa	
120,-	290,-	65,-	180,-	300,-	410,-	
140,-	330,-	65,-	180,-	300,-	470,-	
160,-	380,-	65,-	180,-	300,-	540,-	
180,-	430,-	65,-	180,-	300,-	610,-	
200,-	470,-	65,-	180,-	300,-	670,-	
120,-	290,-	65,-	180,-	300,-	410,-	
140,-	330,-	65,-	180,-	300,-	470,-	
160,-	380,-	65,-	180,-	300,-	540,-	
180,-	430,-	65,-	180,-	300,-	610,-	
200,-	470,-	65,-	180,-	300,-	670,-	

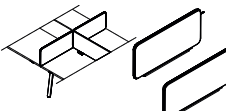
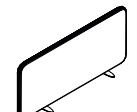
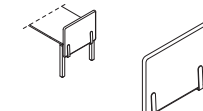
Sonic - panele akustyczne poprzeczne							
	Symbol	Cena netto PLN	Wymiary			Waga Obj. Opak.	Uwagi
			Szer.	Gł.	Wys.		
	ZYS78	1125,-	1600	40	350	12 kg 0.03 m3 2 szt.	do benchy Yan (kpl. 2 szt.);
	ZYS79	1575,-	1600	40	500	8 kg 0.042 m3 2 szt.	
	ZOS58	560,-	577	40	350	3.5 kg 0.011 m3 1 szt.	do benchy Ogi (1 szt.);
	ZOS68	575,-	677	40	350	3.5 kg 0.013 m3 1 szt.	
	ZOS78	595,-	780	40	350	3.1 kg 0.015 m3 1 szt.	
	ZOS10	810,-	577	40	500	2.9 kg 0.015 m3 1 szt.	
	ZOS40	830,-	677	40	500	4 kg 0.018 m3 1 szt.	
	ZOS79	845,-	780	40	500	3.5 kg 0.021 m3 1 szt.	
Sonic - panele akustyczne boczne do biurk pojedynczych							
	ZUS80	700,-	600	40	650	4.5 kg 0.021 m3 1 szt.	wysokość panela liczona od poziomu blatu wynosi 350 mm
	ZUS90	715,-	700	40	650	8.5 kg 0.024 m3 1 szt.	
	ZUS30	735,-	800	40	650	5.2 kg 0.027 m3 1 szt.	
	ZUS60	995,-	600	40	800	7.7 kg 0.025 m3 1 szt.	wysokość panela liczona od poziomu blatu wynosi 500 mm
	ZUS70	1015,-	700	40	800	8 kg 0.029 m3 1 szt.	
	ZUS50	1030,-	800	40	800	6.1 kg 0.033 m3 1 szt.	

Dodatkowa dopłata						
II grupa cenowa	III grupa cenowa	IV grupa cenowa				
160,-	390,-	560,-				
160,-	390,-	560,-				
60,-	150,-	210,-				
70,-	170,-	240,-				
80,-	190,-	280,-				
60,-	150,-	210,-				
70,-	170,-	240,-				
80,-	190,-	280,-				
65,-	150,-	220,-				
75,-	170,-	250,-				
85,-	200,-	280,-				
120,-	300,-	420,-				
140,-	340,-	490,-				
160,-	390,-	550,-				

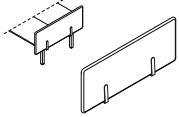
Sonic - panele akustyczne do biur typu bench							Dodatkowa dopłata								
	Symbol	Cena netto PLN	Wymiary			Waga Obj. Opak.	Uwagi	II grupa cenowa	III grupa cenowa	IV grupa cenowa					
			Szer.	Gł.	Wys.										
	ZUS11	825,-	1200	40	650	9 kg 0.041 m3 1 szt.	wysokość panela liczona od poziomu blatu wynosi 350 mm	120,-	290,-	410,-					
	ZUS41	840,-	1400	40	650	6.9 kg 0.047 m3 1 szt.		140,-	340,-	480,-					
	ZUS31	855,-	1600	40	650	11 kg 0.053 m3 1 szt.		160,-	380,-	540,-					
	ZUS61	1125,-	1200	40	800	7.2 kg 0.05 m3 1 szt.	wysokość panela liczona od poziomu blatu wynosi 500 mm	240,-	570,-	810,-					
	ZUS71	1145,-	1400	40	800	12 kg 0.058 m3 1 szt.		280,-	670,-	950,-					
	ZUS51	1160,-	1600	40	800	8.9 kg 0.065 m3 1 szt.		320,-	760,-	1100,-					

Sonic - panele akustyczne do biurk pojedynczych						
Symbol	Cena netto PLN	Wymiary			Waga Obj. Opak.	Uwagi
		Szer.	Gł.	Wys.		
ZPS612	780,-	1190	40	650	5 kg 0.041 m3 1 szt.	do biurk o szer. 1200mm
ZPS614	880,-	1390	40	650	6 kg 0.048 m3 1 szt.	do biurk o szer. 1400mm
ZPS616	980,-	1590	40	650	7 kg 0.054 m3 1 szt.	do biurk o szer. 1600mm
ZPS618	1080,-	1790	40	650	8.5 kg 0.061 m3 1 szt.	do biurk o szer. 1800mm
ZPS620	1205,-	1990	40	650	10 kg 0.067 m3 1 szt.	do biurk o szer. 2000mm
ZPS812	895,-	1190	40	800	7.6 kg 0.05 m3 1 szt.	do biurk o szer. 1200mm
ZPS814	995,-	1390	40	800	8.3 kg 0.058 m3 1 szt.	do biurk o szer. 1400mm
ZPS816	1105,-	1590	40	800	9.1 kg 0.066 m3 1 szt.	do biurk o szer. 1600mm
ZPS818	1205,-	1790	40	800	9.5 kg 0.075 m3 1 szt.	do biurk o szer. 1800mm
ZPS820	1325,-	1990	40	800	10.5 kg 0.082 m3 1 szt.	do biurk o szer. 2000mm

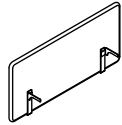

Dodatkowa dopłata						
II grupa cenowa	III grupa cenowa	Lista na akcesoria x1	IV grupa cenowa	Uchwyt Ogi Drive - stelaż		
120,-	290,-	240,-	410,-	320,-		
140,-	330,-	240,-	470,-	320,-		
160,-	380,-	240,-	540,-	320,-		
180,-	430,-	240,-	610,-	320,-		
200,-	470,-	240,-	670,-	320,-		
240,-	570,-	240,-	810,-	320,-		
280,-	660,-	240,-	940,-	320,-		
320,-	750,-	240,-	1050,-	320,-		
350,-	840,-	240,-	1200,-	320,-		
390,-	940,-	240,-	1350,-	320,-		

Zestawienie kolorystyczne - Panele ściennie i sufitowe

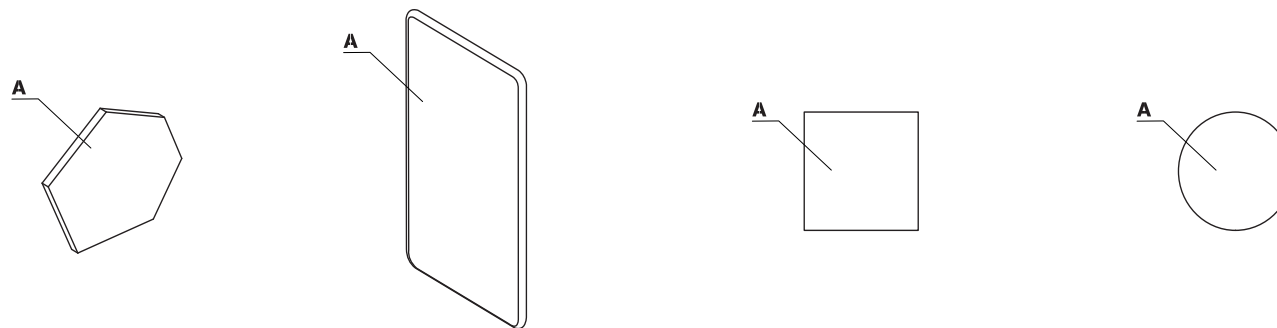

Materiał	Kolor	Panele														
		A - Panel														
Tkanina	Nemo	✓														
	Runner	II grupa ✓														
	Medley	II grupa ✓														
	**Atlantic	II grupa ✓														
	Vita	II grupa ✓														
	Mica	II grupa ✓														
	Go Check	II grupa ✓														
	Charles	II grupa ✓														
	Xtreme	III grupa ✓														
	Synergy	III grupa ✓														
	***Silvertex	III grupa ✓														
	*Tkanina powierzona	II grupa ✓														
	Atlas	IV grupa ✓														
	Field2	IV grupa ✓														

* Zastosowanie tkaniny powierzonej wymaga przeprowadzenia prób tapicerskich, w celu sprawdzenia możliwości wykonawczych

*** Istnieje możliwość zamówienia produktu w pełnej kolorystyce Silvertex wg wzornika Spradling w terminie nie krótszym niż 15 dni roboczych

** Istnieje możliwość zamówienia produktu w pełnej kolorystyce Atlantic wg wzornika Gabriel w terminie nie krótszym niż 7 dni roboczych

Sonic - panele akustyczne ściennie

- 1 Panel** - tapicerowany, konstrukcja wykonana w technologii paneli Sonic, posiadających certyfikat akustyczności klasy A, możliwość wpinania szpilek
- 2 Zamek błyskawiczny** - ozdobny, bez możliwości odpinania, kolor: grafit
- 3 Rama** - konstrukcja z litego drewna klejonego
- 4 Wypełnienie** - włóknina akustyczna o wysokim stopniu pochłaniania i rozpraszania dźwięków
- 5 Zawieszka** - do mocowania na ścianie (w komplecie kołki do mocowania do ścian pełnych i z płyt gipsowo - kartonowych)

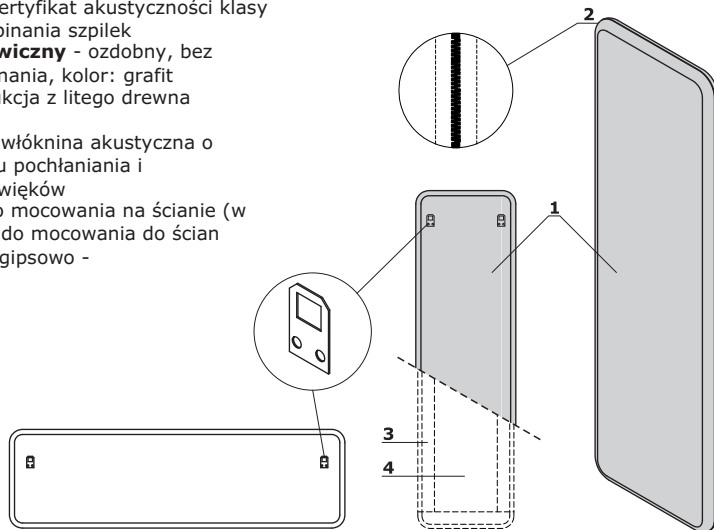

Bazalto - panele ściennie

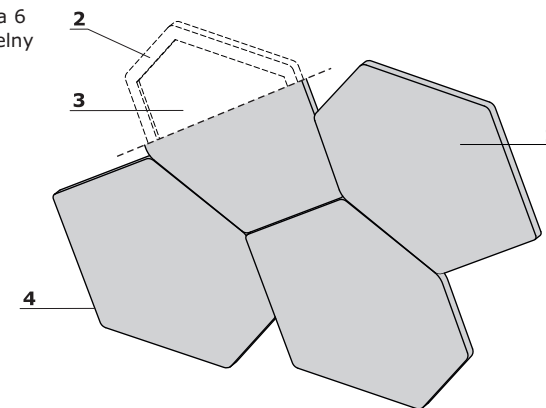

- 1 Panel** - tapicerowany, konstrukcja wykonana w technologii paneli Sonic, posiadających certyfikat akustyczności klasy A, możliwość wpinania szpilek
- 2 Rama** - płyta wiórowa
- 3 Wypełnienie** - włóknina akustyczna o wysokim stopniu pochłaniania i rozpraszania dźwięków
- 4 Mocowanie** - klej (1 opakowanie na 6 szt. paneli) - zamawiany jako oddzielny element (symbol BKL1)



Mix - panele ściennie i sufitowe

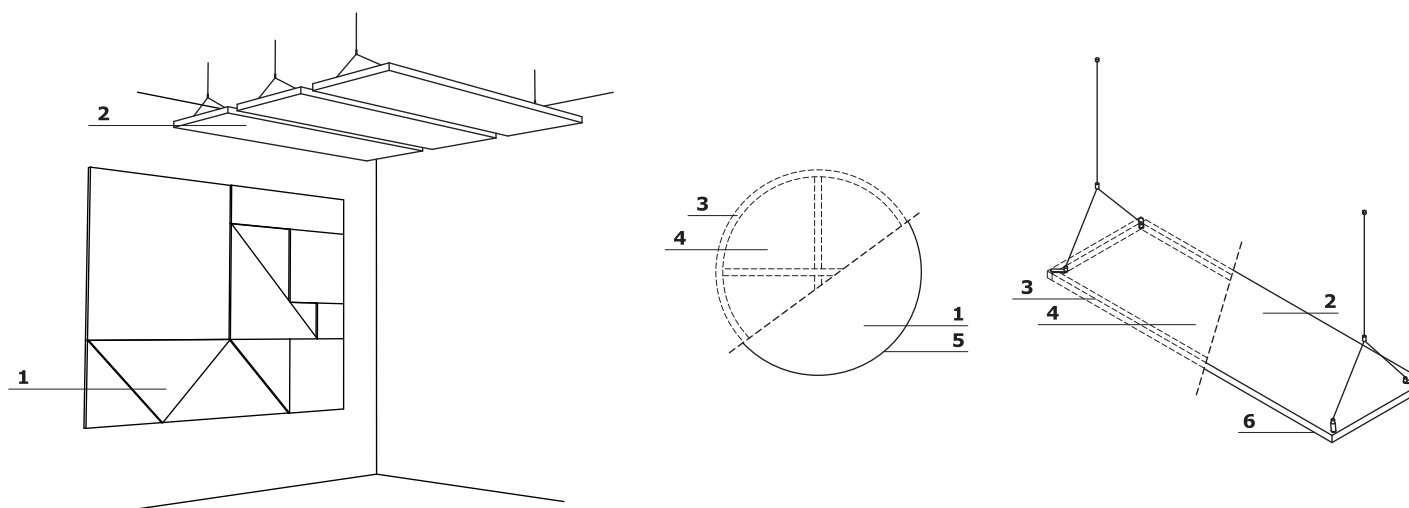

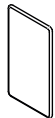
- 1 Panele ściennie** - tapicerowany, konstrukcja wykonana w technologii paneli Sonic, posiadających certyfikat akustyczności klasy A
- 2 Panele sufitowe** - tapicerowany, konstrukcja wykonana w technologii paneli Sonic, posiadających certyfikat akustyczności klasy A
- 3 Rama** - płyta wiórowa
- 4 Wypełnienie** - włóknina akustyczna o wysokim stopniu pochłaniania i rozpraszania dźwięków
- 5 Mocowanie** - klej (1 opakowanie na 6 szt. paneli) - zamawiany jako oddzielny element (symbol BKL1)
- 6 Linka stalowa** - stal nierdzewna, możliwość regulacji długości 200 - 1400 mm





Sonic - panele akustyczne ściennie							
	Symbol	Cena netto PLN	Wymiary			Waga Obj. Opak.	Uwagi
			Szer.	Gł.	Wys.		
	ZAK312	565,-	350	40	1190	9 kg 0.023 m3 1 szt.	montaż poziomo lub pionowo
	ZAK318	665,-	350	40	1790	6.2 kg 0.034 m3 1 szt.	
	ZAK612	755,-	650	40	1190	10 kg 0.041 m3 1 szt.	
	ZAK618	1060,-	650	40	1790	6.9 kg 0.061 m3 1 szt.	
Bazalto - panele ściennie							
	BWP1	250,-	650	21	550	1.7 kg 0.01 m3 1 szt.	w przypadku zamawiania paneli konieczność domówienia kleju montażowego BKL1 (zamawiany jako oddzielna pozycja)
	BWP2	295,-	650	39	550	2.3 kg 0.019 m3 1 szt.	





Dodatkowa dopłata						
II grupa cenowa	III grupa cenowa	IV grupa cenowa				
65,-	160,-	230,-				
85,-	210,-	290,-				
130,-	320,-	460,-				
190,-	460,-	650,-				
80,-	190,-	280,-				
80,-	190,-	280,-				

Mix - panele ściennie							Dodatkowa dopłata								
Symbol	Cena netto PLN	Wymiary			Waga Obj. Opak.	Uwagi	II grupa cenowa	III grupa cenowa	IV grupa cenowa						
		Szer.	Gł.	Wys.											
MX01P	130,-	600	28	300	1.5 kg 0.008 m3 1 szt.		39,-	90,-	130,-						
MX01PG	145,-	600	45	300	1.7 kg 0.012 m3 1 szt.		39,-	90,-	130,-						
MX02P	165,-	900	28	300	1.8 kg 0.012 m3 1 szt.		55,-	130,-	180,-						
MX02PG	180,-	900	45	300	2.4 kg 0.017 m3 1 szt.		55,-	130,-	180,-						
MX03P	200,-	1200	28	300	2 kg 0.015 m3 1 szt.		70,-	160,-	230,-						
MX03PG	220,-	1200	45	300	2.9 kg 0.023 m3 1 szt.		70,-	160,-	230,-						
MX08P	450,-	1800	28	600	3.8 kg 0.045 m3 1 szt.		190,-	460,-	650,-						
MX08PG	525,-	1800	45	600	5.5 kg 0.067 m3 1 szt.		190,-	460,-	650,-						
MX09P	570,-	2400	28	600	5 kg 0.059 m3 1 szt.		250,-	600,-	850,-						
MX09PG	665,-	2400	45	600	7 kg 0.089 m3 1 szt.		250,-	600,-	850,-						

Mix - panele ściennie							
	Symbol	Cena netto PLN	Wymiary			Waga Obj. Opak.	Uwagi
			Szer.	Gł.	Wys.		
	MX04P	100,-	300	28	300	0.8 kg 0.004 m3 1 szt.	
	MX04PG	105,-	300	45	300	1.2 kg 0.006 m3 1 szt.	
	MX05P	180,-	600	28	600	3.1 kg 0.015 m3 1 szt.	
	MX05PG	205,-	600	45	600	2.5 kg 0.023 m3 1 szt.	
	MX06P	320,-	900	28	900	3.5 kg 0.033 m3 1 szt.	
	MX06PG	375,-	900	45	900	3.5 kg 0.05 m3 1 szt.	
	MX07P	450,-	1200	28	1200	5.3 kg 0.059 m3 1 szt.	
	MX07PG	550,-	1200	45	1200	5.4 kg 0.089 m3 1 szt.	
		MX10P	245,-	600	28	600	2.9 kg 0.015 m3 1 szt.
MX10PG		275,-	600	45	600	2.2 kg 0.023 m3 1 szt.	
MX11P		420,-	900	28	900	5.5 kg 0.033 m3 1 szt.	
MX11PG		475,-	900	45	900	9 kg 0.05 m3 1 szt.	
MX12P		585,-	1200	28	1200	8.3 kg 0.059 m3 1 szt.	
MX12PG		685,-	1200	45	1200	13.5 kg 0.089 m3 1 szt.	

Dodatkowa dopłata						
II grupa cenowa	III grupa cenowa	IV grupa cenowa				
24,-	60,-	80,-				
24,-	60,-	80,-				
39,-	90,-	130,-				
39,-	90,-	130,-				
110,-	250,-	360,-				
110,-	250,-	360,-				
130,-	300,-	430,-				
130,-	300,-	430,-				
39,-	90,-	130,-				
39,-	90,-	130,-				
110,-	250,-	360,-				
110,-	250,-	360,-				
130,-	300,-	430,-				
130,-	300,-	430,-				

Mix - panele ściennie								Dodatkowa dopłata							
	Symbol	Cena netto PLN	Wymiary			Waga Obj. Opak.	Uwagi	II grupa cenowa	III grupa cenowa	IV grupa cenowa					
			Szer.	Gł.	Wys.										
	MX13P	145,-	600	28	600	3.9 kg 0.015 m3 1 szt.		39,-	90,-	130,-					
	MX13PG	165,-	600	45	600	1.9 kg 0.023 m3 1 szt.		39,-	90,-	130,-					
	MX14P	255,-	900	28	900	6.2 kg 0.033 m3 1 szt.		110,-	250,-	360,-					
	MX14PG	300,-	900	45	900	2.8 kg 0.05 m3 1 szt.		110,-	250,-	360,-					
	MX15P	360,-	1200	28	1200	8.7 kg 0.059 m3 1 szt.		130,-	300,-	430,-					
	MX15PG	440,-	1200	45	1200	2.2 kg 0.089 m3 1 szt.		130,-	300,-	430,-					
		MX16P	145,-	900	28	450	1.7 kg 0.017 m3 1 szt.		55,-	130,-	180,-				
MX16PG		165,-	900	45	450	2.4 kg 0.026 m3 1 szt.		55,-	130,-	180,-					
MX17P		255,-	1200	28	600	2.5 kg 0.03 m3 1 szt.		70,-	150,-	210,-					
MX17PG		300,-	1200	45	600	3.5 kg 0.045 m3 1 szt.		70,-	150,-	210,-					

Mix - panele sufitowe							
	Symbol	Cena netto PLN	Wymiary			Waga Obj. Opak.	Uwagi
			Szer.	Gł.	Wys.		
	MX06S	470,-	900	45	900	4.5 kg 0.05 m3 1 szt.	
	MX07S	640,-	1200	45	1200	6.4 kg 0.089 m3 1 szt.	
	MX08S	620,-	1800	45	600	6.5 kg 0.067 m3 1 szt.	
	MX09S	760,-	2400	45	600	8 kg 0.089 m3 1 szt.	
	MX11S	565,-	900	45	900	10 kg 0.05 m3 1 szt.	
	MX12S	775,-	1200	45	1200	14.5 kg 0.089 m3 1 szt.	
	MX14S	375,-	900	45	900	3.8 kg 0.05 m3 1 szt.	
	MX15S	510,-	1200	45	1200	5.3 kg 0.089 m3 1 szt.	
Klej do paneli Bazalto i Mix							
	BKL1	80,-	220	50	50	0.4 kg 0.001 m3 1 szt.	klej do paneli; Bazalto (1 opakowanie na 6 szt. paneli), Mix (1 opakowanie na 6 szt. paneli małych lub 3 duże)

Dodatkowa dopłata						
II grupa cenowa	III grupa cenowa	IV grupa cenowa				
110,-	250,-	360,-				
130,-	300,-	430,-				
190,-	460,-	650,-				
250,-	600,-	850,-				
110,-	250,-	360,-				
130,-	300,-	430,-				
110,-	250,-	360,-				
130,-	300,-	430,-				

Zestawienie kolorystyczne - Osłony przednie do biurek

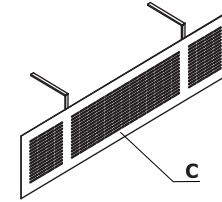
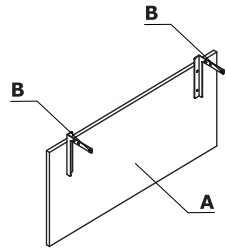

Materiał	Kolor	Osłony płytowe do biurek														
		A - Osłona płytowa	B - Uchwyt - osłona płytowa	C - Osłona rastrowa												
Płyta	26 - aluminium satinato	✓														
	31 - dąb kanadyjski	✓														
	39 - brzoza polarna	✓														
	64 - kakao	✓														
	67 - biały pastel	✓														
	106 - orzech nizinny	✓														
	154 - antracyt	✓														
	08 - czarny	✓														
	14 - buk	✓														
	167 - dąb szary	✓														
	168 - dąb naturalny	✓														
	169 - dąb miodowy	✓														
	170 - akacja	✓														
	171 - orzech ciemny	✓														
Metal	M009 - aluminium półmat RAL 9006		✓	✓												
	M015 - biały półmat RAL 9010		✓	✓												
	M154 - antracyt półmat RAL 7043		✓	✓												
	M115 - czarny półmat RAL 9005		✓	✓												

Osłony do biurtek

- 1 Osłona płytowa** - płyta melaminowana 18 mm, w wyposażeniu kątowniki do mocowania
- 2 Osłona rastrowa** - metal malowany proszkowo, w wyposażeniu kątowniki do mocowania

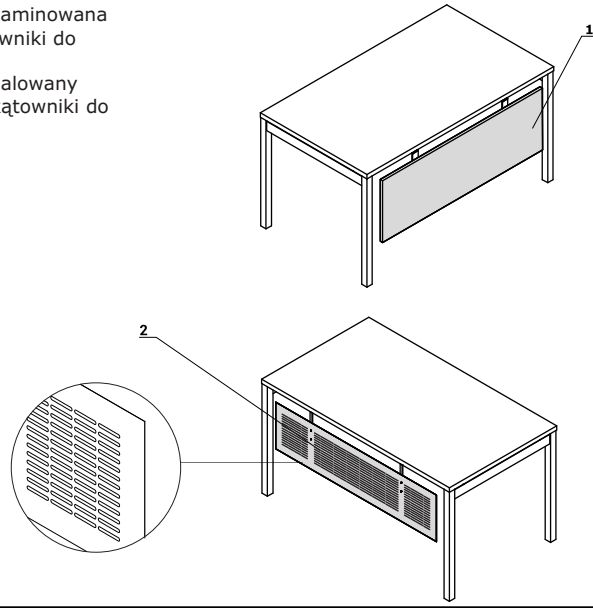

Zestawienie kolorystyczne - Ścianki działowe

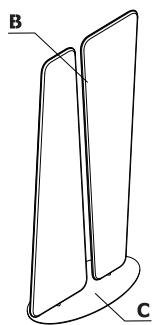
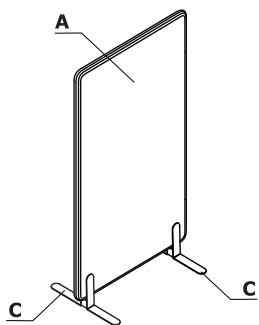

E



E

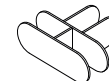

E



E

Materiał	Kolor	Ścianki działowe															
		A - Sonic	B - Viva	C - Stelaż	E - Akcesoria												
Tkanina	Nemo	✓	✓														
	Runner	II grupa	II grupa														
	Medley	II grupa	II grupa														
	**Atlantic	II grupa	II grupa														
	Vita	II grupa	II grupa														
	Mica	II grupa	II grupa														
	Go Check	II grupa	II grupa														
	Charles	II grupa	II grupa														
	Xtreme	III grupa	III grupa														
	Synergy	III grupa	III grupa														
	***Silvertex	III grupa	III grupa														
	*Tkanina powierzona	II grupa	II grupa														
	Atlas	IV grupa	IV grupa														
	Field2	IV grupa	IV grupa														
Metal	M009 - aluminium półmat RAL 9006			✓	✓												
	M015 - biały półmat RAL 9010			✓	✓												
	M154 - antracyt półmat RAL 7043			✓	✓												
	M115 - czarny półmat RAL 9005			✓	✓												

* Zastosowanie tkaniny powierzonej wymaga przeprowadzenia prób tapicerskich, w celu sprawdzenia możliwości wykonawczych

*** Istnieje możliwość zamówienia produktu w pełnej kolorystyce Silvertex wg wzornika Spradling w terminie nie krótszym niż 15 dni roboczych

** Istnieje możliwość zamówienia produktu w pełnej kolorystyce Atlantic wg wzornika Gabriel w terminie nie krótszym niż 7 dni roboczych

Sonic - panele wolnostojące

- 1 **Panel** - klasa akustyczności "A", tapicerowany; możliwość wpinania szpilek
- 2 **Zamek błyskawiczny** - ozdobny, bez możliwości odpinania, kolor: grafit
- 3 **Rama** - konstrukcja z litego drewna klejonego
- 4 **Wypełnienie** - włóknina akustyczna o wysokim stopniu pochłaniania i rozpraszania dźwięków
- 5 **Stopa wolnostojąca** - metal malowany proszkowo
- 6 **Stopka dystansowa** - metal malowany proszkowo; do zastosowania wyłącznie w panelach ustawianych pomiędzy biurkami, lub z innym stabilnym podparciem z obu stron
- 7 **Tablica magnetyczna** - suchościerna

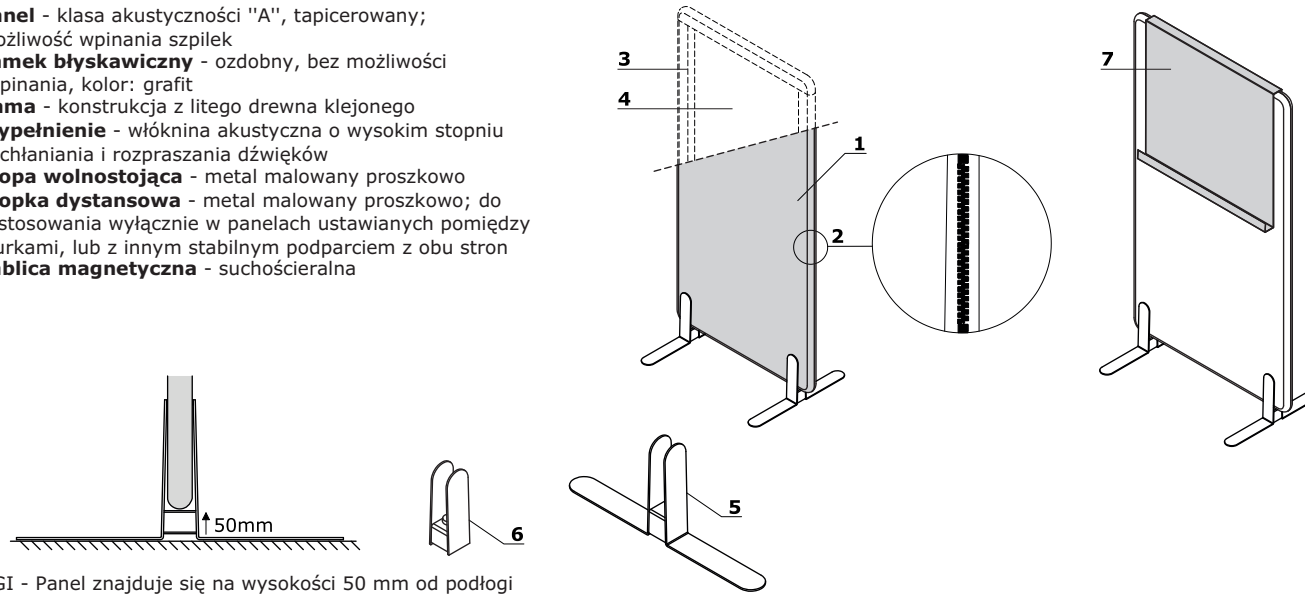

UWAGI - Panel znajduje się na wysokości 50 mm od podłogi

Łączniki do paneli wolnostojących Sonic

- 1 **Łącznik** - metal malowany proszkowo

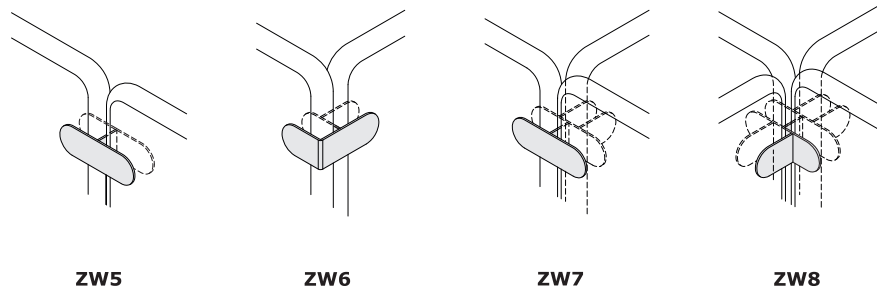

ZW5

ZW6

ZW7

ZW8

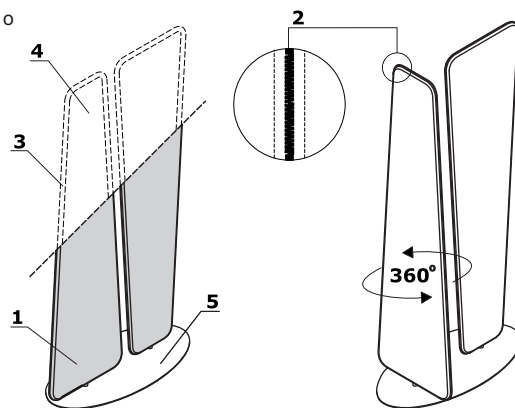

Viva - panel wolnostojący

- 1 **Panel** - tapicerowany, konstrukcja wykonana w technologii paneli Sonic, posiadających certyfikat akustyczności klasy A, możliwość wpinania szpilek
- 2 **Zamek błyskawiczny** - ozdobny, bez możliwości odpinania, kolor: grafit
- 3 **Rama** - rura stalowa
- 4 **Wypełnienie** - włóknina akustyczna o wysokim stopniu pochłaniania i rozpraszania dźwięków
- 5 **Stopa metalowa** - metal malowany proszkowo
- 6 **Obrót 360°** - każdy z paneli obraca się niezależnie



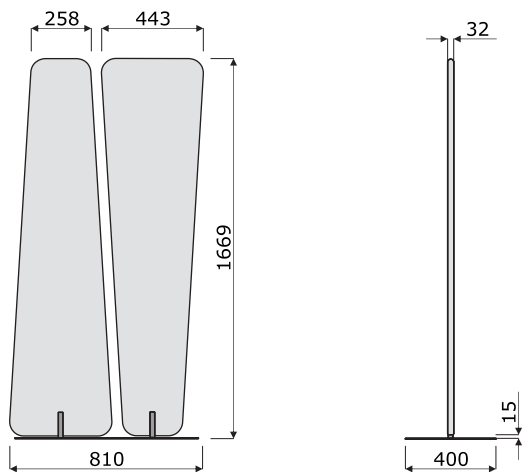

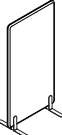
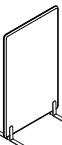

Viva - wymiary (mm)

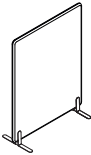

Sonic - panele wolnostojące							
	Symbol	Cena netto PLN	Wymiary			Waga Obj. Opak.	Uwagi
			Szer.	Gł.	Wys.		
	ZW592	810,-	590	40	1250	13.25 kg 0.065 m3 5 szt.	
	ZW594	905,-	590	40	1450	18.65 kg 0.071 m3 5 szt.	
	ZW596	995,-	590	40	1650	14.75 kg 0.077 m3 5 szt.	
	ZW598	1095,-	590	40	1850	20.65 kg 0.083 m3 5 szt.	
	ZW692	890,-	690	40	1250	18.15 kg 0.071 m3 5 szt.	
	ZW694	990,-	690	40	1450	19.15 kg 0.078 m3 5 szt.	
	ZW696	1095,-	690	40	1650	15.35 kg 0.085 m3 5 szt.	
	ZW698	1200,-	690	40	1850	16.25 kg 0.092 m3 5 szt.	
	ZW792	965,-	790	40	1250	14.15 kg 0.077 m3 5 szt.	
	ZW794	1080,-	790	40	1450	14.95 kg 0.085 m3 5 szt.	
	ZW796	1190,-	790	40	1650	15.95 kg 0.093 m3 5 szt.	
	ZW798	1310,-	790	40	1850	16.85 kg 0.101 m3 5 szt.	
	ZW892	1040,-	890	40	1250	14.55 kg 0.083 m3 5 szt.	
	ZW894	1165,-	890	40	1450	15.65 kg 0.092 m3 5 szt.	
	ZW896	1295,-	890	40	1650	21.15 kg 0.101 m3 5 szt.	
	ZW898	1420,-	890	40	1850	22.15 kg 0.11 m3 5 szt.	

Dodatkowa dopłata						
II grupa cenowa	III grupa cenowa	IV grupa cenowa				
130,-	310,-	440,-				
150,-	360,-	510,-				
170,-	400,-	570,-				
190,-	450,-	640,-				
130,-	310,-	440,-				
150,-	360,-	510,-				
170,-	400,-	570,-				
190,-	450,-	640,-				
260,-	620,-	880,-				
300,-	710,-	1000,-				
340,-	810,-	1150,-				
380,-	900,-	1300,-				
260,-	620,-	880,-				
300,-	710,-	1000,-				
340,-	810,-	1150,-				
380,-	900,-	1300,-				

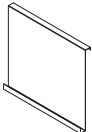
Sonic - panele wolnostojące							
	Symbol	Cena netto PLN	Wymiary			Waga Obj. Opak.	Uwagi
			Szer.	Gł.	Wys.		
	ZW992	1120,-	990	40	1250	15.45 kg 0.089 m3 5 szt.	
	ZW994	1255,-	990	40	1450	16.05 kg 0.099 m3 5 szt.	
	ZW996	1390,-	990	40	1650	17.85 kg 0.109 m3 5 szt.	
	ZW998	1525,-	990	40	1850	19.85 kg 0.12 m3 5 szt.	
Łączniki do paneli wolnostojących Sonic							
	ZW5	70,-	150	37 36.5	50	0.37 kg 0 m3 1 szt.	
	ZW6	84,-	150	116	50	0.37 kg 0.001 m3 1 szt.	
	ZW7	100,-	150	116	50	0.53 kg 0.001 m3 1 szt.	
	ZW8	135,-	150	190 189.5	50	0.69 kg 0.001 m3 1 szt.	
Sonic - panele wolnostojące - akcesoria							
	TB01	355,-	700	92	635	4.5 kg 0.046 m3 1 szt.	tablica magnetyczna - suchościerna

Dodatkowa dopłata									
II grupa cenowa	III grupa cenowa	IV grupa cenowa							
260,-	620,-	880,-							
300,-	710,-	1000,-							
340,-	810,-	1150,-							
380,-	900,-	1300,-							

Viva - panel wolnostojący							
	Symbol	Cena netto PLN	Wymiary			Waga Obj. Opak.	Uwagi
			Szer.	Gł.	Wys.		
	VV02	1805,-	850	400	1670	20.4 kg 0.084 m3 3 szt.	

Dodatkowa dopłata						
II grupa cenowa	III grupa cenowa	IV grupa cenowa				
170,-	410,-	590,-				

Zestawienie kolorystyczne - Stanowisko multimedialne

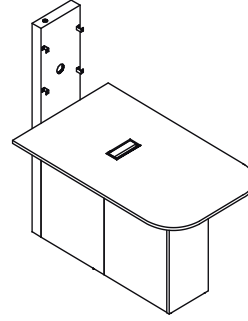

Materiał	Kolor	Stanowisko multimedialne													
		MS01													
Płyta	67 - biały pastel	✓													
	08 - czarny	✓													
	26 - aluminium satynato	✓													

Opis techniczny

- 1 Mediabox M04H** - 2xRJ45 (class E, cat. 6); + 1 x USB + 1 x HDMI + 4 x 230V, kolor mediaboxu dobiera się do kolorystyki stelaża
- 2 Blat** - płyta melaminowana 28 mm, obrzeża ABS
- 3 Podstawa** - płyta melaminowana 28 mm, obrzeża ABS
- 4 Front** - System "Push-to-Open", płyta melaminowana 18 mm, obrzeża ABS
- 5 Uchwyty** - mocowanie VESA, rozstaw 400x400 mm, waga TV max 20 kg

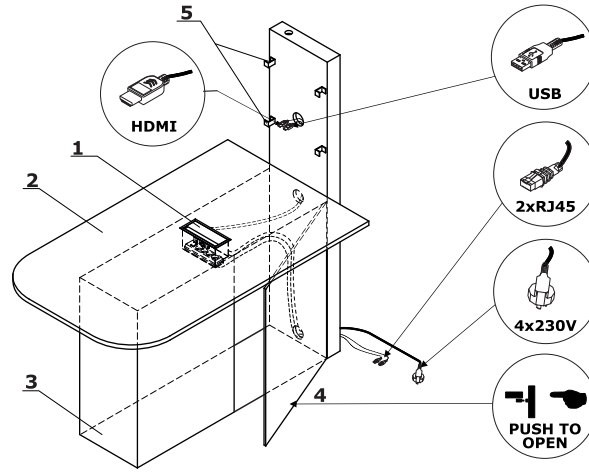

UWAGA - Dostępne tylko gniazda SCHUCKO

Mediabox M04H

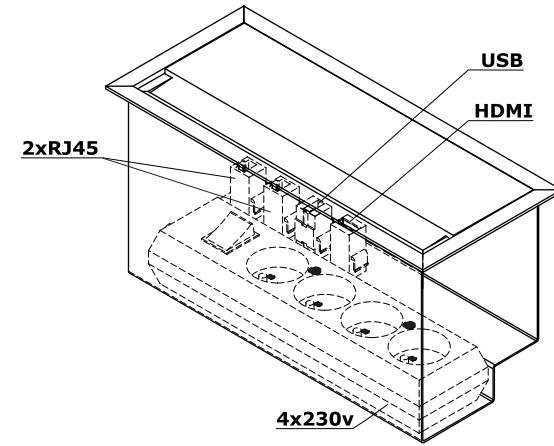

Sposób prowadzenia okablowania

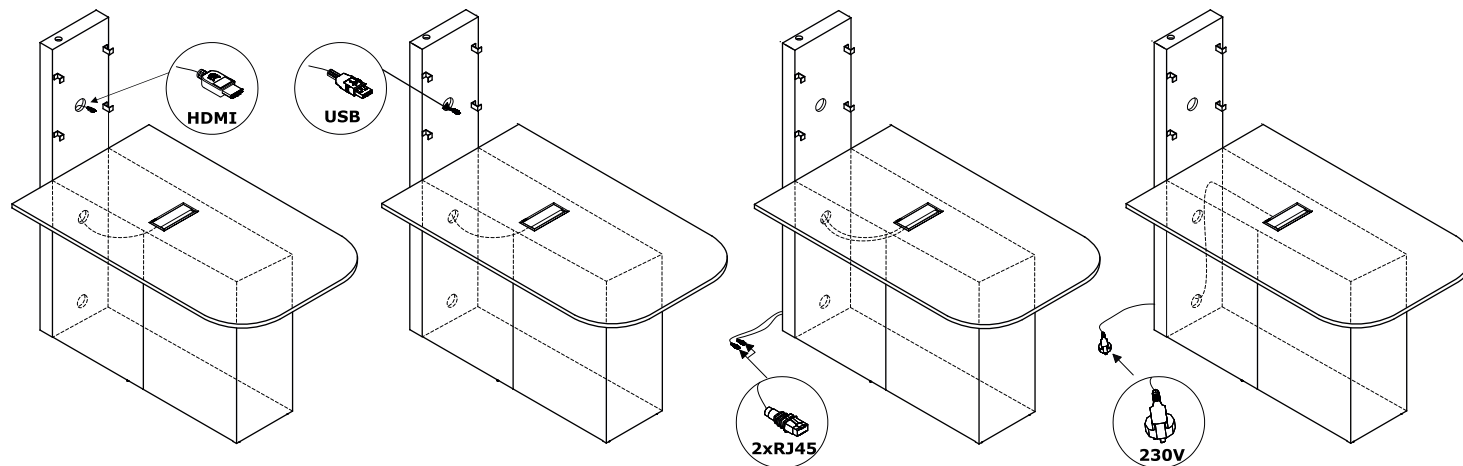

Wymiary (mm)

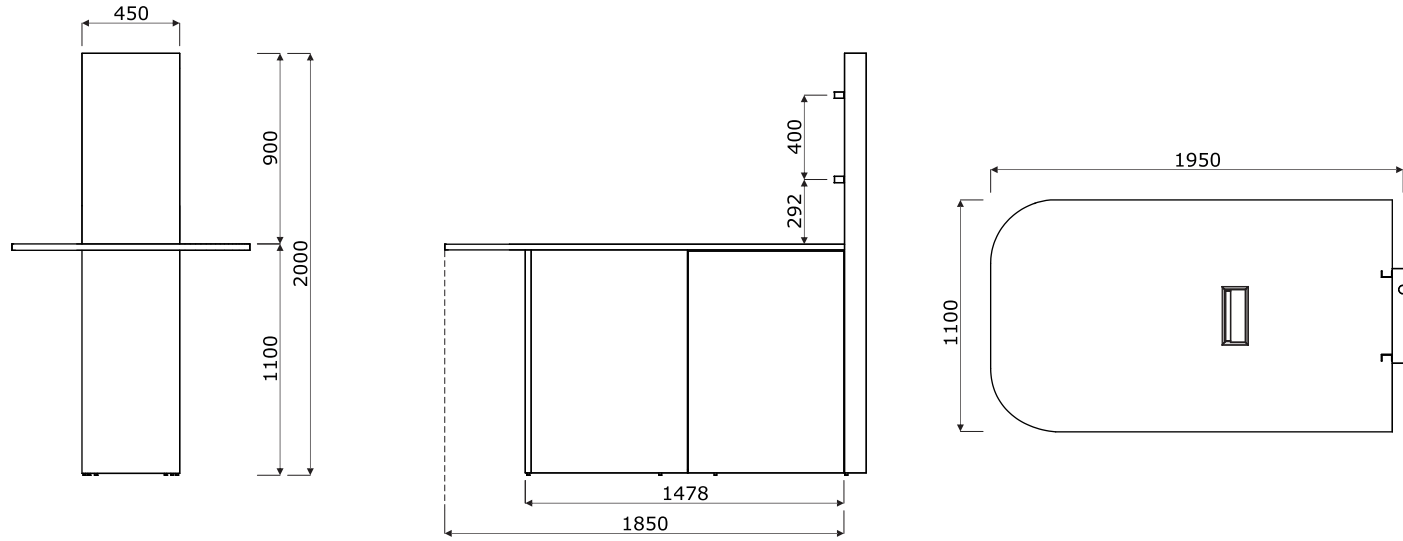

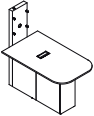
Stanowisko multimedialne							
	Symbol	Cena netto PLN	Wymiary			Waga Obj. Opak.	Uwagi
			Szer.	Gł.	Wys.		
	MS01	5105,-	1100	1950	2000	120.7 kg 0.298 m3 4 szt.	
	MS02	4665,-	1100	1950	1660	99.55 kg 0.247 m3 4 szt.	

Dodatkowa dopłata							

Dane techniczne tkanin

Grupa	Tkanina	Skład	Gramatura	Odporność na ścieranie	Odporność na piling	Odporność na światło	Odporność koloru na ścieranie	Akustyczne pochłanianie dźwięku	Trudnozapałność
I	NEMO	polyester 100%	366g/m2	PN-EN ISO 12947 - 2:2 100,000	scale 1-8, max 8 · PN-EN ISO 105 B02: 2013 (3-4)	scale 1-5, max 5 PN-EN 1021 - 2, PN-EN 1021 - 1	scale 1-5, max 5 EN ISO 105x12 (mokre/suche) 4-5		
II	RUNNER	80% polyester, 20% polyester z recyklingu poużytkowego	320g/m2, 510g/lm	EN ISO 12947-2 BS EN 14465 70,000 cyklki Martindale	skala 1-5, max 5, EN ISO 12945-2 (4-5)	skala 1-8, max 8, EN ISO 105 - B02 (5-7)	skala 1-5, max 5, EN ISO 105x12 (mokre/suche) 4-5	BS EN 1021-2 Match, BS EN 1021-1 Cigarette, California Bulletin CAL 117-E-Class 1, CA TB 117-2013, Class Uno UNI 9175 Class 1	Test akustyczny absorpcji dźwięku ISO 354
II	MEDLEY	polyester 100%	364g/m2, 510g/lm	75,000 cyklki Martindale	skala 1-5, max 5, EN ISO 12945-2 4	skala 1-8, max 8, EN ISO 105 - B02 (5-7)	skala 1-5, max 5, EN ISO 105x12 (mokre/suche) 4-5	BS EN 1021-2 Match, BS EN 1021-1 Cigarette, California Bulletin CAL 117-E-Class 1, CA TB 117-2013, Class Uno UNI 9175 Class 1	Test akustyczny absorpcji dźwięku ISO 354
II	ATLANTIC	polyester 100%	353g/m2, 530g/lm	110,000 cyklki Martindale, EN ISO 12947-2		skala 1-8, max 8, EN ISO 105 - B02 (5-7)	skala 1-5, max 5, EN ISO 105x12 (mokre/suche) 4-5	BS EN 1021-2 Match, BS EN 1021-1 Cigarette, ASTM E 84, BS 476 Part 7, NF P 92-503 M3P, CA TB 117-2013, Class Uno UNI 9175 Class 1	
II	VITA	Surface: PVC, 98,5%, PU 1.5% Substrate: polyester 50%, cotton 50%	850g/m2, 1190g/lm	100,000 cyklki Martindale, EN ISO 5470-2:2003		skala 1-8, max 8, EN ISO 105 - B02 (5-7)	skala 1-5, max 5, EN ISO 105x12 (mokre/suche) 4-5	BS EN 1021-2 Match, BS EN 1021-1 Cigarette, BS 5852:2006 Section 4, Ignition Source 5, NF P 92-503 M2, BS 7176:2017 Medium Hazard, FMVSS 302 (ISO 3795)	Flexing cycles: BS EN ISO 7854:1997 Method B, 400,000 Anti-microbial/ Anti-fungal: AATCC 147:2011
II	RIVER	polyester 100%	300g/m2	100,000 cyklki Martindale, EN ISO 12947-1, 2	EN ISO 12945-2 5	ISO 105 - B02 4	ISO 105-X12:2001 (mokre/suche) 3/4-5	BS 5852: Part 1: 1979, Ignition source 0 Cigarette, BS 5852: Part 1: 1979, Ignition source 1 Match, EN 1021-2	
III	XTREME CS / YS	100% Trevira Clame (CS), 100% Recykling (YS). Polyester zmniejszający palność, Barwniki nie zawierają metali ciężkich.	310g/m2, 435g/lm	60,000 cyklki Martindale (CS) 100,000 cyklki Martindale (YS)		ISO 105 - B02 6	ISO 105-X12:2001 (mokre/suche) 4-4	EN 1021 - 1 (papieros), EN 1021 - 2 (zapalka), BS 7176 Niski stopień zagrożenia, NF P92-507 M1, DIN 4102 B1, UNI 9175 Klasa 1 IM, UNI 8456, UNI 9174 & UNI 9177 Classe Uno, ÖNORM B 3825 & A 3800 -1, NF D 60-013	
III	SYNERGY	Virgin Wool 95%, Polyamide 5%	400g/m2, 560g/lm	100,000 cyklki Martindale		ISO 105 - B02 5	ISO 105-X12:2001 (mokre/suche) 4-4	EN 1021 - 1 (papieros), EN 1021 - 2 (zapalka), BS 7176 Niskie zagrożenie, UNI 9175 Classe 1 IM, ÖNORM B 3825 & A 3800-1	
III	SILVERTEX	warstwa wierzchnia: 100% Winył, podkład: 100% Poliester HI-Loft	685 gr/m2	300,000 cyklki Martindale		>= 7 (1000 godzin, wg skali blue wool)			NF P 92-503 / M2, EN 1021, Część 1&2, DIN 4102 B2 ÖNORM B 3825, Grupa I, ÖNORM A 3800, Część I, IMO Res. MSC.307 (88) (kod 2010 FTP), UNI 91 75 (1987) / UNI 9175/FAL, UNE 23.727-90 IR /M2 EN 71-2: 2006+A1: 2007, ECE R 1 I 8 FMVSS 302, FAR 25/853
III	NOTE	85% wetna z Nowej Zelandii 15% polyamide	510 gr/m2	200,000 cyklki Martindale, EN ISO 12947-2		ISO 105 - B02 8	ISO 105-X12:2001 (mokre/suche) 4/4-5	BS EN 1021 1&2(papieros & zapalka), BS 5852 0,1 papieros & zapalka, MED, Certyfikat IMO, CA TB 117-2013	
IV	FIELD 2	100% Trevira CS	321g/m2, 450g/lm	100,000 cyklki Martindale, EN ISO 12947	EN ISO 12945-2 4-5	ISO 105 B02: 5-7		BS EN 1021-2 Match, BS EN 1021-1 Cigarette, BS 5 5852 Crib 5, DIN 4102 B1 FAR 25.853, UNI 9177 classe 1, US Cal. Bull. 117-2013	
IV	ATLAS	90% new wool, 10% nylon	286g/m2, 400g/lm	100,000 cyklki Martindale, EN ISO 12947	EN ISO 12945-2 4-5	ISO 105 B02: 6-7	ISO 105-X12:2001, (mokre/suche) 4-5/4-5	BS EN 1021-2 Match, BS EN 1021-1 Cigarette, BS 5 5852 Crib 5, BS 5852 ignition source 3, BS 5852 Part 1, NF D 60 013, UNI 9175 1IM, US Cal. Bull. 117-2013	
IV	SKÓRA	Typ - korygowana skóra licowa Rodzaj wykończenia - skóra pigmentowa		Sucha: 500 cyklki - min. 4 w skali szarości Mokra: 250 cyklki - min. 4 w skali szarości UNI EN ISO 11640		Odporność na światło: min. 4 w skali szarości UNI ISO 105-802			Test ognia zapalki: brak zapalenia UNI EN 1021-1-2006 BS EN 1021-1-2006







Dane techniczne tkanin

Grupa	Tkanina	Skład	Gramatura	Odporność na ścieranie	Odporność na piling	Odporność na światło	Odporność koloru na ścieranie	Akustyczne pochłanianie dźwięku	Trudnozapałość
V	ALCANTARA	68% PES, 32% PU, 100 % PES	450g/m2	150,000 cykli Martindale (EN ISO 12947-2)	5 (EN ISO 105-B02)		Sucho: 4, Mokra: 4 (EN ISO 105x12)	Bs5852 Crib 5, EN1021 1+2, ON3800 B1/Q1, CH V.3	



Płyta

 08 - czarny	 26 - aluminium satinato	 31 - dąb kanadyjski	 34 - kasztan	 39 - brzoza polarna	 64 - kakao	 67 - biały pastel	 106 - orzech nizinny
 154 - antracyt	 167 - dąb szary	 168 - dąb naturalny	 169 - dąb miodowy	 170 - akacja	 172 - dąb bursztynowy	 173 - robinia	

Metal

 M009 - aluminium półmat RAL 9006	 M015 - biały półmat RAL 9010	 M115 - czarny półmat RAL 9005	 M154 - antracyt półmat RAL 7043	 17 - chrom	 25 - aluminium polerowane	 Stal nierdzewna INOX
---	---	--	---	---	--	---

Tworzywo/poliuretan/polipropylen

 Biały połysk	 Czarny połysk	 Szary
---	--	--

Sklejka

 Sklejka - jasny jesion
--









Drewno

 Buk	 Czarny
--	---

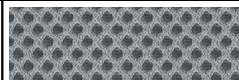







Tkanina Nemo - I grupa cenowa

 NE-1 - beżowy	 NE-2 - żółty	 NE-3 - pomarańczowy	 NE-5 - czerwony	 NE-9 - zielony	 NE-10 - szary	 NE-14 - grafitowy	 NE-15 - granatowy
 NE-16 - czarny	 NE-17 - niebieski						

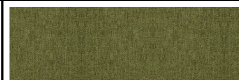



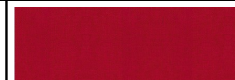
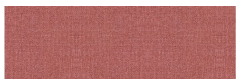

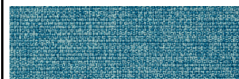
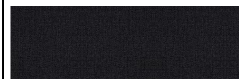

Tkanina Runner - II grupa cenowa

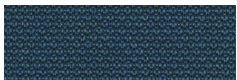
 R-63034 - pomarańczowy	 R-64089 - czerwony	 R-66063 - niebieski	 R-60011 - szary	 R-68056 - zielony	 R-66064 - granatowy	 R-60999 - czarny	 R-60025 - grafitowy
 R-61128 - beżowy	 R-61130 - brązowy						





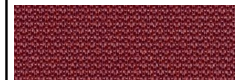

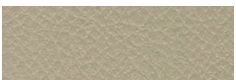

Tkanina Medley - II grupa cenowa

 M-66008 - szary	 M-60003 - jasny szary	 M-61189 - beżowy	 M-68005 - oliwka ciemna	 M-62002 - żółty	 M-62054 - musztardowy	 M-63017 - rdzawy	 M-64019 - czerwony
 M-63064 - różowy	 M-65011 - szaro fioletowy	 M-66010 - niebieski	 M-67006 - niebieski jasny	 M-60999 - czarny			

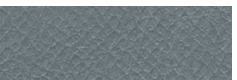

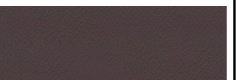
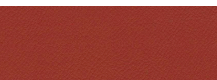



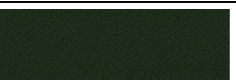



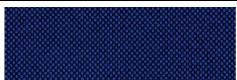



Tkanina Atlantic - II grupa cenowa (Pozostałe kolory Atlantic wg wzornika Gabriel dostępne w terminie nie krótszym niż 7 dni roboczych)

 A-67043 - ciemny turkus	 A-67030 - morski	 A-60141 - jasnoszary	 A-60011 - szary	 A-66064 - granatowy	 A-65037 - fioletowy	 A-62048 - oliwkowy	 A-64089 - czerwony
 A-61078 - beżowy	 A-60025 - grafitowy						















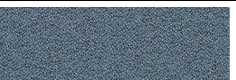

Tkanina Vita - II grupa cenowa

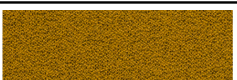
 V-01 - jasny szary	 V-02 - beżowy	 V-03 - żółty	 V-04 - szary	 V-07 - ciemny szary	 V-09 - oliwkowy	 V-10 - szaro brązowy	 V-11 - rdzawy
 V-12 - czarny	 V-13 - czekoladowy	 V-18 - morski	 V-19 - niebieski	 V-29 - ciemny zielony			

Tkanina Go check - II grupa cenowa

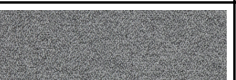
 G-66136 - niebieski	 G-66137 - niebieski ciemny	 G-66134 - fiolet ciemny	 G-66138 - granatowy	 G-66140 - atramentowy	 G-68149 - ciemny zielony	 G-68152 - zielony	 G-60079 - szary
 G-64183 - marsala	 G-63079 - pomarańczowy	 G-64171 - czerwony	 G-64172 - bordowy	 G-61144 - brązowy	 G-61145 - brązowy ciemny		

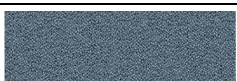
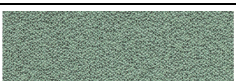
Tkanina Mica - II grupa cenowa

 MC-01 - różowy	 MC-02 - czerwony	 MC-03 - ciemny czerwony	 MC-04 - granatowy	 MC-05 - niebieski	 MC-06 - morski	 MC-07 - zielony butelkowy	 MC-08 - zielony
 MC-09 - oliwkowy	 MC-10 - oliwka jasna	 MC-11 - musztardowy	 MC-12 - żółty	 MC-13 - beżowy	 MC-14 - jasny szary	 MC-15 - szary	 MC-16 - grafitowy
 MC-17 - niebieski jasny	 MC-18 - miętowy	 MC-19 - bordowy					

Tkanina Charles - II grupa cenowa

 C-01 - czarny	 C-05 - szary	 C-06 - beżowy	 C-14 - brązowy	 C-18 - rdzawy	 C-21 - czerwony	 C-30 - różowy	 C-31 - marsala
 C-32 - niebieski ciemny	 C-35 - niebieski	 C-41 - żółty	 C-44 - oliwkowy	 C-45 - zielony			

Tkanina Synergy - III grupa cenowa

 LDS88 - oberżyna	 LDS86 - czerwony	 LDS85 - koralowy	 LDS84 - pomarańczowy	 LDS69 - granatowy	 LDS61 - śliwkowy	 LDS60 - zielony butelkowy	 LDS50 - ciemny zielony
 LDS53 - zielony	 LDS57 - turkusowy	 LDS29 - ciemny szary	 LDS27 - czarny	 LDS20 - jasny szary	 LDS08 - szary melanż	 LDS19 - beżowy	 LDS44 - żółty
 LDS79 - brązowy							

Tkanina Xtreme - III grupa cenowa









 XR108 - beżowy	 XR094 - szary	 XR081 - ciemny szary	 XR420 - oliwkowy	 XR009 - czarny	 XR026 - granatowy	 YS071 - jasny brąz	 YS030 - bordowy
 YS076 - pomarańczowy	 YS072 - żółty	 YS045 - zielony	 YS100 - niebieski				

Tkanina Silvertex - III grupa cenowa - Istnieje możliwość zamówienia produktu w pełnej kolorystyce Silvertex wg wzornika Spradling w terminie nie krótszym niż 15 dni roboczych.

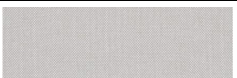
Tkanina Atlas - IV grupa cenowa

 AS-531 - pomarańczowy	 AS-501 - różowy	 AS-651 - czerwony	 AS-681 - bordowy	 AS-391 - brązowy	 AS-781 - granatowy	 AS-161 - ciemny szary	 AS-111 - jasny szary
 AS-971 - jasny zielony	 AS-981 - ciemny zielony						

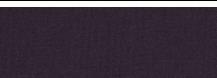
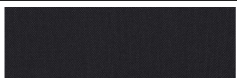
Tkanina Field2 - IV grupa cenowa

 FD-463 - żółty	 FD-963 - zielony	 FD-123 - beżowy	 FD-132 - szary	 FD-142 - grafit	 FD-662 - czerwony	 FD-782 - granatowy	 FD-693 - bordowy
 FD-192 - czarny	 FD-673 - niebiesko-czerwony						