

OPIS TECHNICZNY

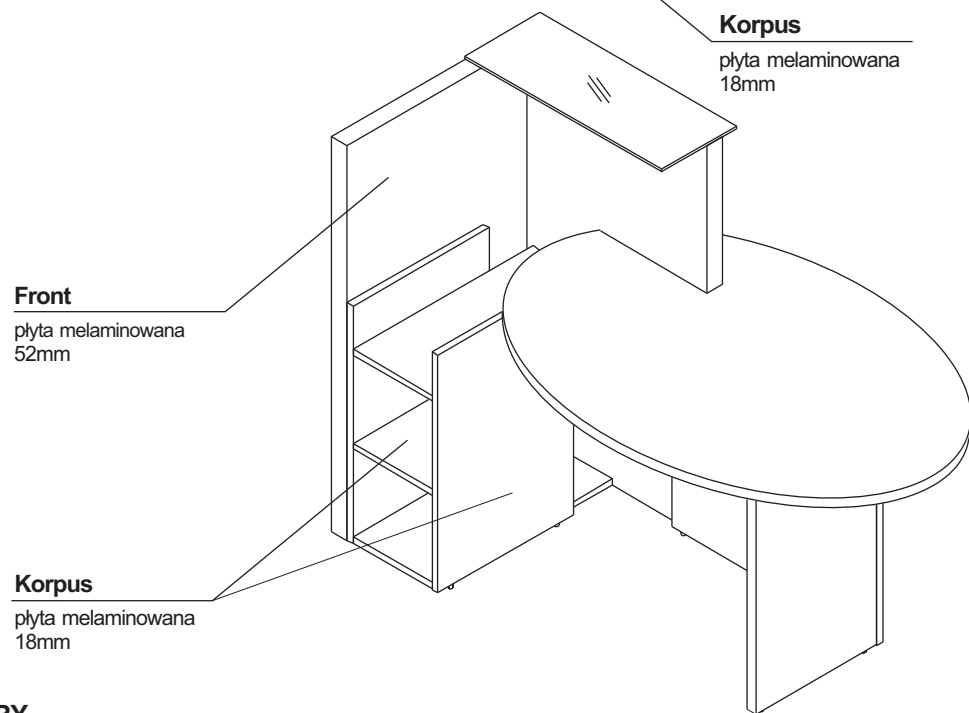

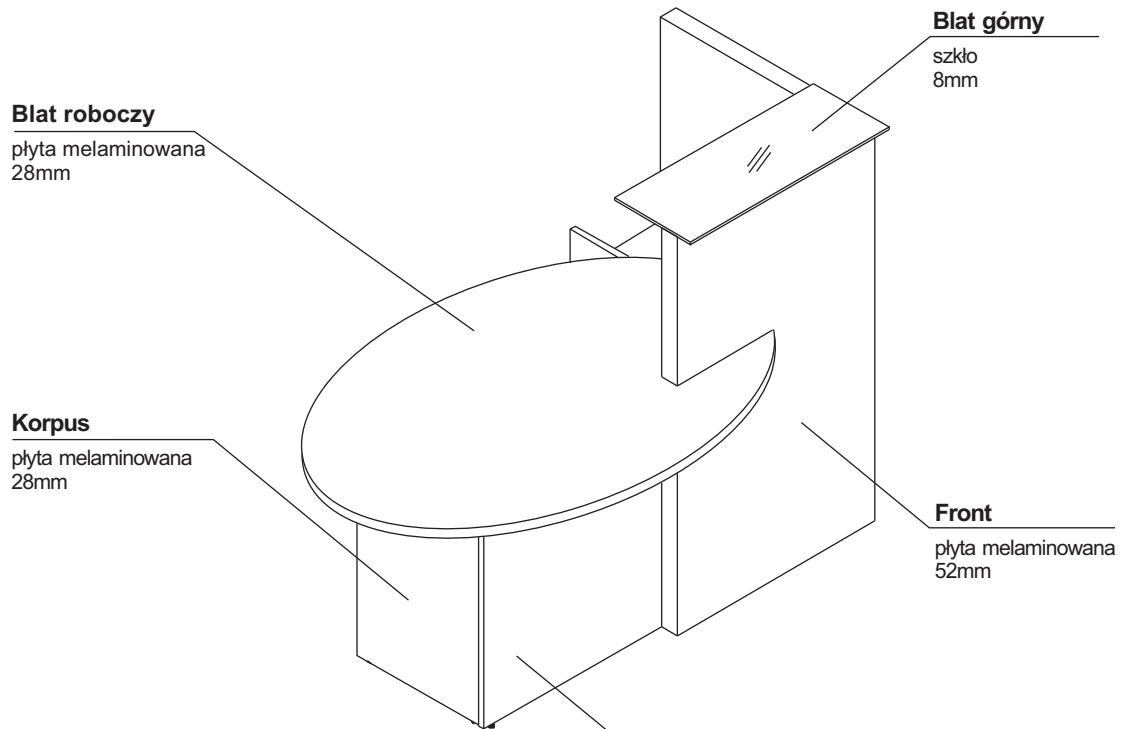

WYMIARY

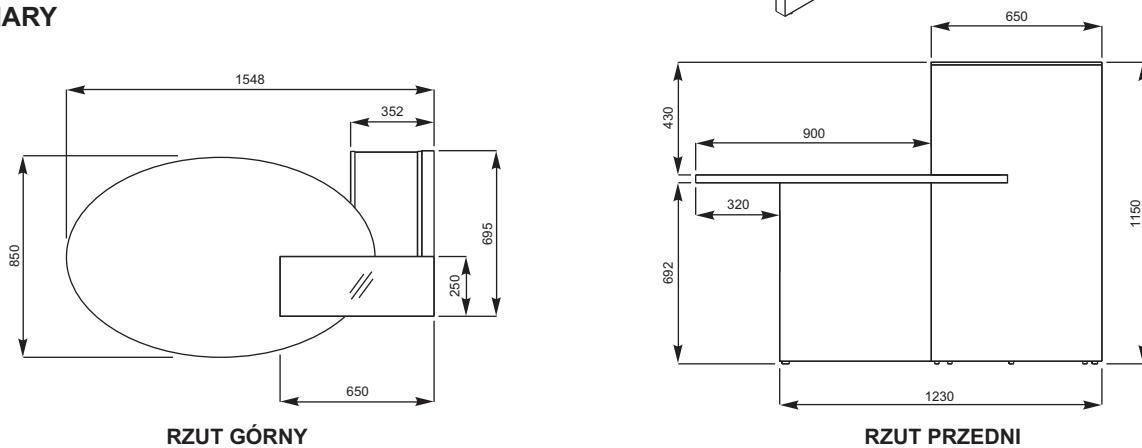



KOLORYSTYKA

BLAT GÓRNY 	SZKŁO SATYNOWANE
KORPUS, BLAT ROBOCZY 	67-BIAŁY PASTEL
FRONT 	34-KASZTAN 64-COCOA

WIDOK OBIEKTU	WYMIARY (mm)			SYMBOL				UWAGI
	SZEROKOŚĆ	GLĘBOKOŚĆ	WYSOKOŚĆ		kg	m ³	szt	

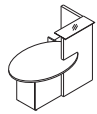
LADA OVO

	1550	870	1150	LOP10	85,6	0,24	3	
	1550	870	1150	LOL10	85,6	0,24	3	

LEGENDA:

 - WAGA NETTO

 - OBJĘTOŚĆ

 - ILOŚĆ PACZEK