

Cennik dla klientów prowadzących działalność na rynku profesjonalnym

CENNIK

Obowiązuje od 01.05.2012

B2B

[kawiarnia]

dom
kuchnia
jadalnia
restauracja
kawiarnia
sala konferencyjna
hotel

przyjazne krzesła do każdego wnętrza



[SPIS TREŚCI]

P – OFERTA PREMIUM
S – OFERTA STANDARD
EX – OFERTA EXPRESS

kolejność alfabetyczna

2 ACEROLA II P	10 CLUB S EX	58 HARPO S	50 MOLINO HOCKER P	65 SUNNY TABLE P
2 ALANI P	10 COLISA P	20 HELLO! P	64 MOLINO TABLE P	65 TIRAMISU TABLE P EX
2 ALGEO P	72 CRACOW P	67 HELLO! TABLE P	30 NERON S EX	36 TIZIANO P EX
67 ALGEO TABLE P	12 DECO S	22 INABA P	50 NERON HOCKER S	54 TIZIANO HOCKER P EX
76 ALSACE NF TABLE P	12 DOLCE P	48 JOLA HOCKER P EX	74 PALERMO P	61 TOP P
2 AMIGO P	44 DOLCE HOCKER P	62 KAJA TABLE S EX	74 PARIS P	65 TRACY TABLE P EX
4 AMMI P	62 DONA-3 TABLE S	63 KARINA TABLE S EX	52 PINACOLADA HOCKER P	36 TULIPAN S
4 ANCA P	62 DONA-4 TABLE S	22 KLIWIA P	58 PINACOLADA STOOL P	36 TULIPAN PLUS S EX
6 ANNATO P	14 DORINO P EX	22 LAKKA P	64 PINACOLADA TABLE P	54 TULIPAN HOCKER S
61 ARIZONA EX	66 DORINO TABLE P	24 LANTANA P	30 POLYFOLD S	76 TUSCANY NF TABLE P
6 BALENO P	14 EL SOL P EX	63 LARA INOX TABLE P	52 RETRO HOCKER S	65 UP&DOWN TABLE P
42 BALENO HOCKER P	66 ERYK TABLE P	24 LATTE P EX	66 RICO TABLE S EX	38 VENUS S EX
72 BERGAMO P	14 ESPRESSO P	26 LATTE A PLUS P	60 RINGO P EX	56 VENUS HOCKER S EX
6 BINGO P	16 FANO P	28 LATTE B PLUS P EX	52 RINGO HOCKER P	38 VERBENA P
42 BINGO HOCKER P	16 FIAMMA P	50 LATTE HOCKER P	32 ROSA P	74 VIENNA P
8 BISTRO P	46 FIAMMA HOCKER P	63 LENA TABLE P EX	32 ROSSO S	40 WAIT P
42 BISTRO HOCKER P	16 FIUGGI P	72 LISBON P	52 ROSSO HOCKER S	65 WIKTOR TABLE S EX
62 BISTRO TABLE P	72 FLORENCE P	28 LULA P	64 ROZANA TABLE S	60 ZEPPU S
62 CAFE TABLE P	62 FLORIDA TABLE S	74 MADRID P	32 SAMBA P EX	56 ZETA HOCKER S EX
8 CALDO P	18 FONDO P	30 MEDEA P	64 SKY TABLE P EX	40 ZEUS S
44 CALDO HOCKER P	48 FONDO HOCKER P	64 MELBA TABLE P	65 SONIA TABLE S	
10 CAPPUCINO P EX	20 FOSCA P	64 MELLO TABLE P	34 SOLEIL P	
76 CATALONIA NF TABLE P	20 FRAPPE P EX	76 MODERN NF TABLE P	34 SQUERTO P	
58 CHICO S	58 GRAPPO S	30 MOLINO P	65 SQUERTO A TABLE P	

KILKA WSKAZÓWEK

- ▶ Wszystkie krzesła przeznaczone są do użytkowania do 8 h dziennie przez osoby ważące do 110 kg wg limitów zawartych w normie PN EN 1335.
- ▶ Podane wymiary mogą się różnić od rzeczywistych o $\pm 2\%$.
- ▶ Każdy produkt w cenniku posiada termin realizacji zależny od rodzaju oferty i wykończenia.
- ▶ Szczegółowe wykończenia metalowe (chrome, alu, kwarc lub black) umieszczone są obok nazwy produktu.
- ▶ Produkt występuje w wykończeniach tapicerek, przy których znajdują się ceny.
- ▶ Istnieje możliwość zamówienia modeli w niestandardowych wykończeniach lub wersjach niewystępujących w cenniku za **dodatkową dopłatą 25%** do ustalonej ceny netto. Realizacja zamówienia nastąpi po uzgodnieniu z Działem Sprzedaży Krajowej terminu i zaakceptowaniu oferty.
- ▶ Wszystkie produkty posiadają 2 lata gwarancji.
- ▶ Firma Nowy Styl zastrzega sobie prawo do:
 - zmian konstrukcyjnych,
 - zmian wymiarów,
 - zmian terminów dostaw,
 - usunięcia produktów,
 - zmian w palecie wykończeń.

ZNACZENIE IKON



– Produkt posiada Certyfikat Sprawzonego Bezpieczeństwa GS nadany przez TÜV Rheinland Group.

REMODEX

– Produkt posiada Atest Badań Wytrzymałościowych wydany przez Zakład Badań i Wdrożeń Przemysłu Meblarskiego P.U.R. – Remodex Sp. z o.o.



– Produkt posiada Certyfikat Wytrzymałościowy włoskiego Instytutu Badań CATAS S.p.A.



– Nowy produkt lub nowa wersja



– Produkt przeznaczony do użytku na zewnątrz – odporny na warunki atmosferyczne



01 NOWE KOLORY RAM LINII FONDO

Sukces linii **FONDO** sprawił, że zdecydowaliśmy o rozszerzeniu oferty. Do dostępnych dotychczas ram chromowanych wysokiej jakości chromem C+ oraz malowanych proszkowo na kolor alu, dołączyliśmy **5 nowych kombinacji** ram i kubeków. Nowe zestawienia kolorów odpowiadają na najnowsze tendencje w wyposażeniu wnętrz komercyjnych i prywatnych.

- ▶ Ceny i informacje techniczne na stronie 18 (FONDO i FONDO arm).
- ▶ Ceny i informacje techniczne na stronie 48 (FONDO hocker).

- ▶ RAL 9005 (czarny)
Gloss White



- ▶ RAL 7016 (grafitowy)
Gloss Anthracite



- ▶ RAL 2003 (pomarańczowy)
Gloss Orange



- ▶ RAL 9003 (biały)
Gloss White



- ▶ RAL 9005 (czarny)
Gloss Orange

Nowe kombinacje obejmują modele FONDO, FONDO arm i FONDO hocker i przedstawiają się następująco:

KOLOR RAMY	KOLOR KUBEŁKA
RAL 7016 (GRAFITOWY)	GLOSS ANTHRACITE
RAL 2003 (POMARAŃCZOWY)	GLOSS ORANGE
RAL 9003 (BIAŁY)	GLOSS WHITE
RAL 9005 (CZARNY)	GLOSS WHITE
RAL 9005 (CZARNY)	GLOSS ORANGE

02 NOWE WZORY LAMINATÓW



Do standardowych wzorów laminatów dostępnych dla krzeseł sklejkowych został dodany nowy kolor określony symbolem **U773**.



U773



Do oferty laminatów została wprowadzona możliwość laminowania wzorem poprzecznym H3005. Dla odróżnienia od dotychczasowego zastosowania tego laminatu, wykonanie wzoru poprzecznego będzie określone **H3005 horizontal**.



H3005 horizontal

03 LAMINOWANIE KRZESZEŁ ACEROLA I COLISA



ACEROLA II

Krzeseło Acerola dołączyło do grupy krzeseł sklejkowych, które dostępne są we wszystkich wzorach laminatów.

- ▶ Ceny i informacje techniczne na stronie 2.



COLISA

Krzeseło Colisa dołączyło do grupy krzeseł sklejkowych, które dostępne są we wszystkich wzorach laminatów.

- ▶ Ceny i informacje techniczne na stronie 10.



04 NOWE STOPKI



W krzesełach sklejkowych wprowadzono **nowe stopki**. Zastąpiły one używane dotychczas stopki nakładane na ramę o przekroju okrągłym.

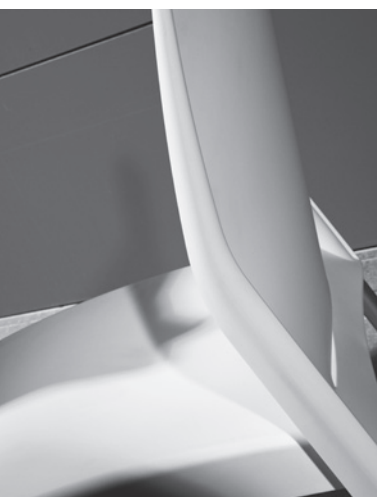

KRZESŁA

strona 2–41

ACEROLA II	2	COLISA	10–12	INABA	22	ROSSO	32
ALANI	2	DECO	12	KLIWIA	22	SAMBA	32–34
ALGEO	2	DOLCE	12	LAKKA	22–24	SOLEIL	☼ 34
AMIGO	2	DORINO	14	LANTANA	24	SQUERTO	34
AMMI	4	EL SOL	☼ 14	LATTE	24–26	TIZIANO	36
ANCA	4	ESPRESSO	14	LATTE A PLUS	26	TULIPAN	36
ANNATO	6	FANO	☼ 16	LATTE B PLUS	28	TULIPAN PLUS	36
BALENO	6	FIAMMA	16	LULA	☼ 28	VENUS	38
BINGO	6–8	FIUGGI	☼ 16	MEDEA	30	VERBENA	38–40
BISTRO	8	FONDO	☼ 18–20	MOLINO	30	WAIT	☼ 40
CALDO	8	FOSCA	20	NERON	30	ZEUS	40
CAPPUCINO	10	FRAPPE	☼ 20	POLYFOLD	30–32		
CLUB	10	HELLO!	20–22	ROSA	32		

STOŁKI BAROWE

strona 42–57

BALENO	42	FIAMMA	46	NERON	50–52	TIZIANO	54
BINGO	42	FONDO	☼ 48	PINACOLADA	52	TULIPAN	54
BISTRO	42–44	JOLA	48–50	RETRO	52	VENUS	56
CALDO	44	LATTE	50	RINGO	52	ZETA	56
DOLCE	44–46	MOLINO	50	ROSSO	52		

TABORETY

strona 58–61

CHICO	58	HARPO	58	RINGO	60
GRAPPO	58	PINACOLADA	58	ZEPPPO	60

WIESZAKI

strona 61

ARIZONA	61	TOP	61
---------	----	-----	----

PODSTAWY STOŁÓW

strona 62–65

BISTRO	62	KAJA	63	MOLINO	64	SUNNY	☼ 65
CAFE	62	KARINA	63	PINACOLADA	64	TIRAMISU	65
DONA-3	62	LARA INOX	☼ 63	ROZANA	64	TRACY	65
DONA-4	62	LENA	63–64	SKY	☼ 64	UP&DOWN	65
FLORIDA	62	MELBA	64	SONIA	65	WIKTOR	65
KAJA 500	62	MELLO	64	SQUERTO A	65		

STOŁY

strona 66–67

ALGEO	67	ERYK	☼ 66	RICO	66
DORINO	66	HELLO!	67		

BLATY

strona 69–71

DREWNIANE KRZESŁA I STOŁKI BAROWE











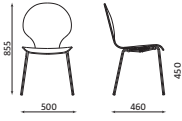

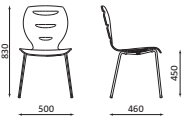

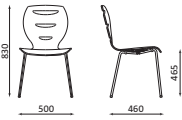
strona 72–75

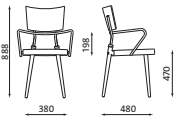
BERGAMO	72	LISBON	72–74	PARIS	74
CRACOW	72	MADRID	74	VIENNA	74
FLORENCE	72	PALERMO	74		

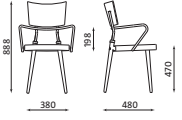
DREWNIANE STOŁY Z BLATAMI MELAMINOWYMI

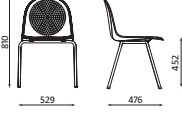
strona 76

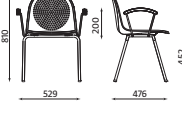
ALSACE NF MA	76	CATALONIA NF MA	76	MODERN NF MA	76	TUSCANY NF MA	76
--------------	----	-----------------	----	--------------	----	---------------	----

ważne informacje	składowanie w stosie max ilość [szt.]	objętość kartonu [m ³]	ilość w kartonie [szt.]	waga netto [kg]	siedzisko – szerokość [mm]	siedzisko – głębokość [mm]	MODEL		
							wymiary w mm		
REMODEX	4	0,38	4	4,90	475	415			ACEROLA II alu
									ACEROLA II chrome
REMODEX	4	0,38	4	4,90	470	430			ALANI alu
									ALANI chrome
REMODEX	4	0,38	4	4,90	470	430			ALANI seat plus alu
									ALANI seat plus chrome
REMODEX		0,41	2	5,20	Ø 430				ALGEO chrome
REMODEX		0,41	2	5,40	Ø 430				ALGEO plus chrome
REMODEX	8	0,34	4	4,32	460	460			AMIGO alu
									AMIGO chrome
REMODEX	8	0,34	4	5,74	460	460			AMIGO ARM alu
									AMIGO ARM chrome



Produkty posiadają Atest Badań Wytrzymałościowych.

Nowy Styl zastrzega sobie prawo do zmian: konstrukcyjnych, wymiarów, terminów dostaw; usunięcia produktów i zmian w paletce wykończeń.











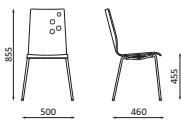

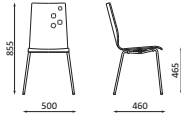
SZCZEGÓŁOWE WYKOŃCZENIA	TERMIN REALIZACJI	CENA MODELU W ZALEŻNOŚCI OD WYKOŃCZENIA [zł]						OFERTA
		TKANINA PODSTAWOWA (C/CU)	MICRO (M) SKAJ (V)	OBAN (EF) LUCIA (YB)	MICROFIRBA (CM) NOBLE LUX (NL) SOTI (SI)	ELEGANCE (EC) TECHNO (TCH) OXYGEN (OX)	CONTRACT (YN) NEXUS (UNY)	
LAMINAT	21	294 netto 361,62 brutto						P
LAMINAT	21	298 netto 366,54 brutto						P
DREWNO	21	235 netto 289,05 brutto						P
LAMINAT	21	294 netto 361,62 brutto						
DREWNO	21	238 netto 292,74 brutto						P
LAMINAT	21	298 netto 366,54 brutto						
DREWNO	21		248 netto 305,04 brutto	254 netto 312,42 brutto	257 netto 316,11 brutto	263 netto 323,49 brutto	259 netto 318,57 brutto	P
LAMINAT	21		308 netto 378,84 brutto	313 netto 384,99 brutto	317 netto 389,91 brutto	323 netto 397,29 brutto	319 netto 392,37 brutto	
DREWNO	21		251 netto 308,73 brutto	257 netto 316,11 brutto	260 netto 319,80 brutto	266 netto 327,18 brutto	262 netto 322,26 brutto	P
LAMINAT	21		311 netto 382,53 brutto	317 netto 389,91 brutto	320 netto 393,60 brutto	326 netto 400,98 brutto	322 netto 396,06 brutto	
DREWNO	14	439 netto 539,97 brutto						P
DREWNO	14		525 netto 645,75 brutto	536 netto 659,28 brutto	540 netto 664,20 brutto	552 netto 678,96 brutto	546 netto 671,58 brutto	P
TWORZYWO SZTUCZNE	21	94 netto 115,62 brutto						P
TWORZYWO SZTUCZNE	14	96 netto 118,08 brutto						P
TWORZYWO SZTUCZNE	21	137 netto 168,51 brutto						P
TWORZYWO SZTUCZNE	14	140 netto 172,20 brutto						P

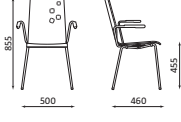
drewno: 1.007, 1.040, 1.010, 1.008, 1.016, 1.042, 1.023, 1.031, 1.033, 1.043
laminat: H1733, H3389, H3005, H3005 horizontal, H3704, W1000, U303, U630, U773, U321, U999
tworzywo sztuczne: szczegółowe wykończenia we wzorniku katalogu Kawiarnia.

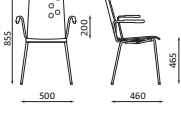
oferta: P – premium, S – standard, EX – express

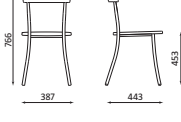
TERMIN REALIZACJI w dniach kalendarzowych.
ZP – ZA POTWIERDZENIEM – oznacza każdorazowe uzgadnianie terminu realizacji z Działem Handlowym.

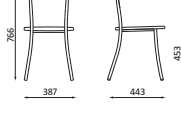

ważne informacje	składowanie w stosie max ilość [szt.]	objętość kartonu [m ³]	ilość w kartonie [szt.]	waga netto [kg]	siedzisko – szerokość [mm]	siedzisko – głębokość [mm]	MODEL		
							wymiary w mm		
REMODEX	4	0,32	4	4,90	395	425			AMMI alu
									AMMI chrome
REMODEX	4	0,32	4	5,35	395	425			AMMI seat plus alu
									AMMI seat plus chrome
REMODEX	4	0,34	4	5,80	395	425			AMMI ARM alu
									AMMI ARM chrome
REMODEX	4	0,34	4	5,80	395	425			AMMI ARM seat plus alu
									AMMI ARM seat plus chrome
REMODEX		0,22	2	5,06	Ø410				ANCA wood alu
									ANCA wood chrome
REMODEX		0,22	2	5,15	Ø410				ANCA plus alu
									ANCA plus chrome













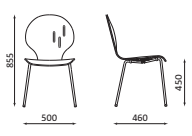

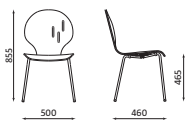

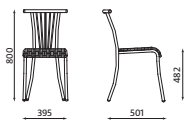

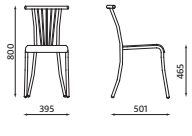
SZCZEGÓŁOWE WYKOŃCZENIA	TERMIN REALIZACJI	CENA MODELU W ZALEŻNOŚCI OD WYKOŃCZENIA [zł]						OFERTA
		TKANINA PODSTAWOWA (C/CU)	MICRO (M) SKAJ (V)	OBAN (EF) LUCIA (YB)	MICROFIRBA (CM) NOBLE LUX (NL) SOTI (SI)	ELEGANCE (EC) TECHNO (TCH) OXYGEN (OX)	CONTRACT (YN) NEXUS (UNY)	
DREWNO	21	235 netto 289,05 brutto						P
LAMINAT	21	294 netto 361,62 brutto						
DREWNO	21	238 netto 292,74 brutto						P
LAMINAT	21	298 netto 366,54 brutto						
DREWNO	21		248 netto 305,04 brutto	254 netto 312,42 brutto	257 netto 316,11 brutto	263 netto 323,49 brutto	259 netto 318,57 brutto	P
LAMINAT	21		308 netto 378,84 brutto	313 netto 384,99 brutto	317 netto 389,91 brutto	323 netto 397,29 brutto	319 netto 392,37 brutto	P
DREWNO	21		251 netto 308,73 brutto	257 netto 316,11 brutto	260 netto 319,80 brutto	266 netto 327,18 brutto	262 netto 322,26 brutto	P
LAMINAT	21		311 netto 382,53 brutto	317 netto 389,91 brutto	320 netto 393,60 brutto	326 netto 400,98 brutto	322 netto 396,06 brutto	P
DREWNO	21	301 netto 370,23 brutto						P
LAMINAT	21	361 netto 444,03 brutto						P
DREWNO	21	304 netto 373,92 brutto						P
LAMINAT	21	364 netto 447,72 brutto						P
DREWNO	21		314 netto 386,22 brutto	320 netto 393,60 brutto	323 netto 397,29 brutto	329 netto 404,67 brutto	325 netto 399,75 brutto	P
LAMINAT	21		374 netto 460,02 brutto	380 netto 467,40 brutto	383 netto 471,09 brutto	389 netto 478,47 brutto	385 netto 473,55 brutto	P
DREWNO	21		318 netto 391,14 brutto	323 netto 397,29 brutto	326 netto 400,98 brutto	332 netto 408,36 brutto	328 netto 403,44 brutto	P
LAMINAT	21		377 netto 463,71 brutto	383 netto 471,09 brutto	386 netto 474,78 brutto	392 netto 482,16 brutto	388 netto 477,24 brutto	P
DREWNO	21	205 netto 252,15 brutto						P
DREWNO	21	217 netto 266,91 brutto						P
	21		161 netto 198,03 brutto	178 netto 218,94 brutto	181 netto 222,63 brutto	188 netto 231,24 brutto	184 netto 226,32 brutto	P
	21		173 netto 212,79 brutto	186 netto 228,78 brutto	189 netto 232,47 brutto	198 netto 243,54 brutto	194 netto 238,62 brutto	P

drewno: 1.007, 1.040, 1.010, 1.008, 1.016, 1.042, 1.023, 1.031, 1.033, 1.043
laminat: H1733, H3389, H3005, H3005 horizontal, H3704, W1000, U303, U630, U773, U321, U999
tworzywo sztuczne: szczegółowe wykończenia we wzorniku katalogu Kawiarnia.

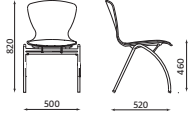
oferta: P – premium, S – standard, EX – express

TERMIN REALIZACJI w dniach kalendarzowych.
ZP – ZA POTWIERDZENIEM – oznacza każdorazowe uzgadnianie terminu realizacji z Działem Handlowym.

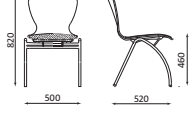

ważne informacje	składowanie w stosie max ilość [szt.]	objętość kartonu [m ³]	ilość w kartonie [szt.]	waga netto [kg]	siedzisko – szerokość [mm]	siedzisko – głębokość [mm]	MODEL		
							wymiary w mm		
REMODEX	4	0,38	4	4,90	470	430			ANNATO alu
									ANNATO chrome
REMODEX	4	0,38	4	4,90	470	430			ANNATO seat plus alu
									ANNATO seat plus chrome
REMODEX		0,31	2	4,90	378	356			BALENO alu
									BALENO chrome
REMODEX		0,31	2	4,80	378	356			BALENO wood alu
									BALENO wood chrome
 REMODEX	4	0,44	4	6,10	445	455			BINGO wood alu
									BINGO wood chrome
 REMODEX	4	0,44	4	6,50	445	455			BINGO seat plus alu
									BINGO seat plus chrome













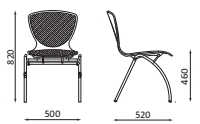

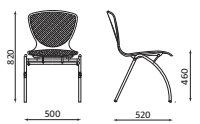

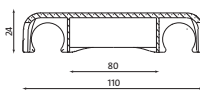

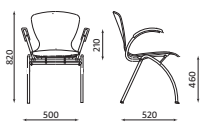

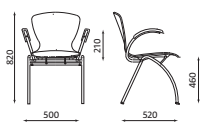
SZCZEGÓŁOWE WYKOŃCZENIA	TERMIN REALIZACJI	CENA MODELU W ZALEŻNOŚCI OD WYKOŃCZENIA [zł]						OFERTA
		TKANINA PODSTAWOWA (C/CU)	MICRO (M) SKAJ (V)	OBAN (EF) LUCIA (YB)	MICROFIRBA (CM) NOBLE LUX (NL) SOTI (SI)	ELEGANCE (EC) TECHNO (TCH) OXYGEN (OX)	CONTRACT (YN) NEXUS (UNY)	
DREWNO	21	235 netto 289,05 brutto						P
LAMINAT	21	294 netto 361,62 brutto						P
DREWNO	21	238 netto 292,74 brutto						P
LAMINAT	21	298 netto 366,54 brutto						P
DREWNO	21		248 netto 305,04 brutto	254 netto 312,42 brutto	257 netto 316,11 brutto	263 netto 323,49 brutto	259 netto 318,57 brutto	P
LAMINAT	21		308 netto 378,84 brutto	313 netto 384,99 brutto	317 netto 389,91 brutto	323 netto 397,29 brutto	319 netto 392,37 brutto	P
DREWNO	21		251 netto 308,73 brutto	257 netto 316,11 brutto	260 netto 319,80 brutto	266 netto 327,18 brutto	262 netto 322,26 brutto	P
LAMINAT	21		311 netto 382,53 brutto	317 netto 389,91 brutto	320 netto 393,60 brutto	326 netto 400,98 brutto	322 netto 396,06 brutto	P
	21		162 netto 199,26 brutto	184 netto 226,32 brutto	188 netto 231,24 brutto	196 netto 241,08 brutto	192 netto 236,16 brutto	P
	14		179 netto 220,17 brutto	197 netto 242,31 brutto	200 netto 246,00 brutto	207 netto 254,61 brutto	203 netto 249,69 brutto	P
DREWNO	21	192 netto 236,16 brutto						P
DREWNO	14	201 netto 247,23 brutto						P
DREWNO	21	272 netto 334,56 brutto						P
LAMINAT	21	318 netto 391,14 brutto						P
DREWNO	14	277 netto 340,71 brutto						P
LAMINAT	21	322 netto 396,06 brutto						P
DREWNO	21		286 netto 351,78 brutto	291 netto 357,93 brutto	294 netto 361,62 brutto	301 netto 370,23 brutto	297 netto 365,31 brutto	P
LAMINAT	21		331 netto 407,13 brutto	336 netto 413,28 brutto	340 netto 418,20 brutto	346 netto 425,58 brutto	342 netto 420,66 brutto	P
DREWNO	21		290 netto 356,70 brutto	296 netto 364,08 brutto	299 netto 367,77 brutto	305 netto 375,15 brutto	301 netto 370,23 brutto	P
LAMINAT	21		335 netto 412,05 brutto	341 netto 419,43 brutto	344 netto 423,12 brutto	350 netto 430,50 brutto	346 netto 425,58 brutto	P

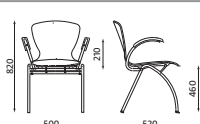
drewno: 1.007, 1.040, 1.010, 1.008, 1.016, 1.042, 1.023, 1.031, 1.033, 1.043
laminat: H1733, H3389, H3005, H3005 horizontal, H3704, W1000, U303, U630, U773, U321, U999
tworzywo sztuczne: szczegółowe wykończenia we wzorniku katalogu Kawiarnia.

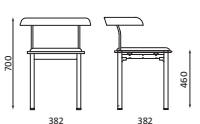
oferta: P – premium, S – standard, EX – express

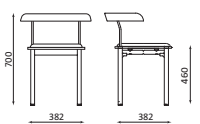
TERMIN REALIZACJI w dniach kalendarzowych.
ZP – ZA POTWIERDZENIEM – oznacza każdorazowe uzgadnianie terminu realizacji z Działem Handlowym.

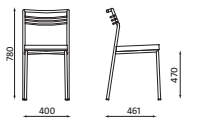

ważne informacje	składowanie w stosie max ilość [szt.]	objętość kartonu [m ³]	ilość w kartonie [szt.]	waga netto [kg]	siedzisko – szerokość [mm]	siedzisko – głębokość [mm]	MODEL wymiary w mm		
									
	4	0,44	4	6,80	445	455			BINGO plus alu
									BINGO plus chrome
									BINGO LINK do połączenia przednich i tylnych nóg krzeseł Bingo (2 szt. w komplecie)
	4	0,52	4	7,50	445	455			BINGO ARM wood alu
									BINGO ARM wood chrome
	4	0,52	4	7,80	445	455			BINGO ARM seat plus alu
									BINGO ARM seat plus chrome
	4	0,52	4	7,80	445	455			BINGO ARM plus alu
									BINGO ARM plus chrome
	4	0,32	4	6,50	Ø430				BISTRO alu
									BISTRO chrome
	4	0,32	4	6,90	Ø430				BISTRO plus alu
									BISTRO plus chrome
	6	0,25	2	5,00	378	365			CALDO alu
									CALDO chrome



SZCZEGÓŁOWE WYKOŃCZENIA	TERMIN REALIZACJI	CENA MODELU W ZALEŻNOŚCI OD WYKOŃCZENIA [zł]						OFERTA
		TKANINA PODSTAWOWA (C/CU)	MICRO (M) SKAJ (V)	OBAN (EF) LUCIA (YB)	MICROFIRBA (CM) NOBLE LUX (NL) SOTI (SI)	ELEGANCE (EC) TECHNO (TCH) OXYGEN (OX)	CONTRACT (YN) NEXUS (UNY)	
DREWNO	21		299 netto 367,77 brutto	309 netto 380,07 brutto	315 netto 387,45 brutto	329 netto 404,67 brutto	321 netto 394,83 brutto	P
LAMINAT	21		344 netto 423,12 brutto	354 netto 435,42 brutto	361 netto 444,03 brutto	374 netto 460,02 brutto	366 netto 450,18 brutto	P
DREWNO	21		303 netto 372,69 brutto	313 netto 384,99 brutto	320 netto 393,60 brutto	333 netto 409,59 brutto	325 netto 399,75 brutto	P
LAMINAT	21		348 netto 428,04 brutto	359 netto 441,57 brutto	365 netto 448,95 brutto	378 netto 464,94 brutto	370 netto 455,10 brutto	P
	14		10 netto 12,30 brutto					P
DREWNO	21		366 netto 450,18 brutto					P
DREWNO	14		377 netto 463,71 brutto					P
DREWNO	21		380 netto 467,40 brutto	385 netto 473,55 brutto	388 netto 477,24 brutto	394 netto 484,62 brutto	390 netto 479,70 brutto	P
DREWNO	21		391 netto 480,93 brutto	396 netto 487,08 brutto	399 netto 490,77 brutto	406 netto 499,38 brutto	402 netto 494,46 brutto	P
DREWNO	21		392 netto 482,16 brutto	403 netto 495,69 brutto	409 netto 503,07 brutto	423 netto 520,29 brutto	414 netto 509,22 brutto	P
DREWNO	21		404 netto 496,92 brutto	414 netto 509,22 brutto	420 netto 516,60 brutto	434 netto 533,82 brutto	426 netto 523,98 brutto	P
DREWNO	21		213 netto 261,99 brutto					P
DREWNO	14		222 netto 273,06 brutto					P
DREWNO	21		224 netto 275,52 brutto	239 netto 293,97 brutto	242 netto 297,66 brutto	250 netto 307,50 brutto	246 netto 302,58 brutto	P
DREWNO	21		233 netto 286,59 brutto	247 netto 303,81 brutto	250 netto 307,50 brutto	258 netto 317,34 brutto	255 netto 313,65 brutto	P
	21		214 netto 263,22 brutto	224 netto 275,52 brutto	226 netto 277,98 brutto	233 netto 286,59 brutto	229 netto 281,67 brutto	P
	14		245 netto 301,35 brutto	256 netto 314,88 brutto	258 netto 317,34 brutto	264 netto 324,72 brutto	261 netto 321,03 brutto	P

drewno: 1.007, 1.040, 1.010, 1.008, 1.016, 1.042, 1.023, 1.031, 1.033, 1.043
 laminat: H1733, H3389, H3005, H3005 horizontal, H3704, W1000, U303, U630, U773, U321, U999
 tworzywo sztuczne: szczegółowe wykończenia we wzorniku katalogu Kawiarnia.

oferta: P – premium, S – standard, EX – express

TERMIN REALIZACJI w dniach kalendarzowych.
 ZP – ZA POTWIERDZENIEM – oznacza każdorazowe uzgadnianie terminu realizacji z Działem Handlowym.



ważne informacje	składowanie w stosie max ilość [szt.]	objętość kartonu [m ³]	ilość w kartonie [szt.]	waga netto [kg]	siedzisko – szerokość [mm]	siedzisko – głębokość [mm]	MODEL	
							wymiary w mm	
REMODEX	4	0,32	4	4,50	470	430		CAPPUCINO alu
								CAPPUCINO chrome
REMODEX		0,37	1	16,00	480	500		CLUB *
REMODEX		0,68	1	28,60	1066	500		CLUB DUO *
REMODEX		0,93	1	38,00	1570	500		CLUB TRIO *
REMODEX	4	0,32	4	4,90	395	425		COLISA alu
								COLISA chrome
REMODEX	4	0,32	4	4,90	395	425		COLISA seat plus alu
								COLISA seat plus chrome

*Linia CLUB dostępna także w innych wykończeniach – patrz cennik Biuro



Produkty posiadają Atest Badań Wytrzymałościowych.
Nowy Styl zastrzega sobie prawo do zmian: konstrukcyjnych, wymiarów, terminów dostaw; usunięcia produktów i zmian w palecie wykończeń.











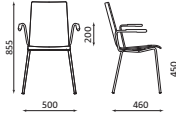

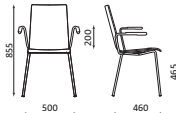
SZCZEGÓŁOWE WYKOŃCZENIA	TERMIN REALIZACJI	CENA MODELU W ZALEŻNOŚCI OD WYKOŃCZENIA [zł]						OFERTA
		TKANINA PODSTAWOWA (C/CU)	MICRO (M) SKAJ (V)	OBAN (EF) LUCIA (YB)	MICROFIRBA (CM) NOBLE LUX (NL) SOTI (SI)	ELEGANCE (EC) TECHNO (TCH) OXYGEN (OX)	CONTRACT (YN) NEXUS (UNY)	
DREWNO	21	206 netto 253,38 brutto						P
LAMINAT	21	249 netto 306,27 brutto						
1.007, 1.010, 1.033	7	209 netto 257,07 brutto						EX
POZOSTAŁE KOLORY DREWNA	14	209 netto 257,07 brutto						P
LAMINAT	21	252 netto 309,96 brutto						P
	14	tylko w V 395 netto 485,85 brutto		tylko w TG 415 netto 510,45 brutto		tylko w EF 428 netto 526,44 brutto	S	
	7	tylko w V-46, V-82, V-98, V-04 395 netto 485,85 brutto						EX
	14	tylko w V 671 netto 825,33 brutto		tylko w TG 696 netto 856,08 brutto		tylko w EF 724 netto 890,52 brutto	S	
	14	tylko w V 886 netto 1089,78 brutto		tylko w TG 903 netto 1110,69 brutto		tylko w EF 957 netto 1177,11 brutto	S	
DREWNO	21	235 netto 289,05 brutto						P
LAMINAT	21	294 netto 361,62 brutto						P
DREWNO	21	238 netto 292,74 brutto						P
LAMINAT	21	298 netto 366,54 brutto						P
DREWNO	21		248 netto 305,04 brutto	254 netto 312,42 brutto	257 netto 316,11 brutto	263 netto 323,49 brutto	259 netto 318,57 brutto	P
DREWNO	21		251 netto 308,73 brutto	257 netto 316,11 brutto	260 netto 319,80 brutto	266 netto 327,18 brutto	262 netto 322,26 brutto	P

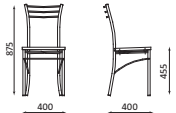
drewno: 1.007, 1.040, 1.010, 1.008, 1.016, 1.042, 1.023, 1.031, 1.033, 1.043
laminat: H1733, H3389, H3005, H3005 horizontal, H3704, W1000, U303, U630, U773, U321, U999
tworzywo sztuczne: szczegółowe wykończenia we wzorniku katalogu Kawiarnia.

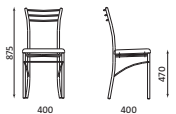
oferta: P – premium, S – standard, EX – express

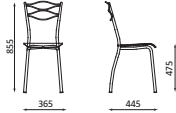
TERMIN REALIZACJI w dniach kalendarzowych.
ZP – ZA POTWIERDZENIEM – oznacza każdorazowe uzgadnianie terminu realizacji z Działem Handlowym.

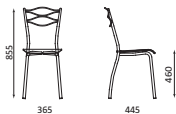

ważne informacje	składowanie w stosie max ilość [szt.]	objętość kartonu [m ³]	ilość w kartonie [szt.]	waga netto [kg]	siedzisko – szerokość [mm]	siedzisko – głębokość [mm]	MODEL		
							wymiary w mm		
REMODEX	4	0,34	4	5,80	395	415			COLISA ARM alu
									COLISA ARM chrome
REMODEX	4	0,34	4	5,80	395	425			COLISA ARM seat plus alu
									COLISA ARM seat plus chrome
REMODEX		0,24	2	4,40	410	350			DECO wood alu
									DECO wood chrome
REMODEX		0,24	2	4,40	410	350			DECO plus alu
									DECO plus chrome
REMODEX		0,25	2	4,00	360	360			DOLCE alu
									DOLCE chrome
REMODEX		0,25	2	3,80	360	360			DOLCE wood alu
									DOLCE wood chrome



Produkty posiadają Atest Badań Wytrzymałościowych.

Nowy Styl zastrzega sobie prawo do zmian: konstrukcyjnych, wymiarów, terminów dostaw; usunięcia produktów i zmian w palecie wykończeń.











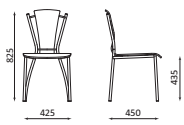

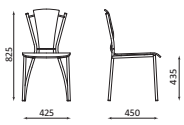
SZCZEGÓŁOWE WYKOŃCZENIA	TERMIN REALIZACJI	CENA MODELU W ZALEŻNOŚCI OD WYKOŃCZENIA [zł]						OFERTA
		TKANINA PODSTAWOWA (C/CU)	MICRO (M) SKAJ (V)	OBAN (EF) LUCIA (YB)	MICROFIRBA (CM) NOBLE LUX (NL) SOTI (SI)	ELEGANCE (EC) TECHNO (TCH) OXYGEN (OX)	CONTRACT (YN) NEXUS (UNY)	
DREWNO	21	301 netto 370,23 brutto						P
DREWNO	21	304 netto 373,92 brutto						P
DREWNO	21		314 netto 386,22 brutto	320 netto 393,60 brutto	323 netto 397,29 brutto	329 netto 404,67 brutto	325 netto 399,75 brutto	P
DREWNO	21		318 netto 391,14 brutto	323 netto 397,29 brutto	326 netto 400,98 brutto	332 netto 408,36 brutto	328 netto 403,44 brutto	P
1.007, 1.008, 1.010, 1.031	21	182 netto 223,86 brutto						S
1.007, 1.008, 1.010, 1.031	14	203 netto 249,69 brutto						S
	21	136 netto 167,28 brutto	136 netto 167,28 brutto					S
	14	155 netto 190,65 brutto	155 netto 190,65 brutto					S
	21		173 netto 212,79 brutto	179 netto 220,17 brutto	185 netto 227,55 brutto	201 netto 247,23 brutto	193 netto 237,39 brutto	P
	14		186 netto 228,78 brutto	194 netto 238,62 brutto	200 netto 246,00 brutto	205 netto 252,15 brutto	202 netto 248,46 brutto	P
DREWNO	21	205 netto 252,15 brutto						P
DREWNO	14	221 netto 271,83 brutto						P

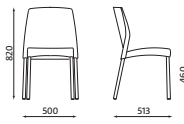
drewno: 1.007, 1.040, 1.010, 1.008, 1.016, 1.042, 1.023, 1.031, 1.033, 1.043
laminat: H1733, H3389, H3005, H3005 horizontal, H3704, W1000, U303, U630, U773, U321, U999
tworzywo sztuczne: szczegółowe wykończenia we wzorniku katalogu Kawiarnia.

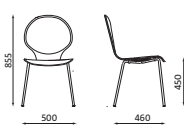
oferta: P – premium, S – standard, EX – express

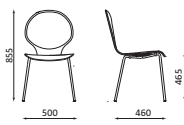
TERMIN REALIZACJI w dniach kalendarzowych.
ZP – ZA POTWIERDZENIEM – oznacza każdorazowe uzgadnianie terminu realizacji z Działem Handlowym.

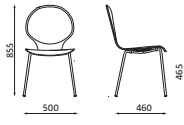

ważne informacje	składowanie w stosie max ilość [szt.]	objętość kartonu [m ³]	ilość w kartonie [szt.]	waga netto [kg]	siedzisko – szerokość [mm]	siedzisko – głębokość [mm]	MODEL		
							wymiary w mm		
REMODEX		0,25	2	5,40	450	405			DORINO alu
									DORINO chrome
REMODEX		0,25	2	5,70	450	405			DORINO plus alu
									DORINO plus chrome
	4	0,32	4	3,5	410	420			EL SOL aluminium
REMODEX	4	0,32	4	4,40	470	430			ESPRESSO alu
									ESPRESSO chrome
REMODEX	4	0,32	4	5,40	470	430			ESPRESSO seat plus alu
									ESPRESSO seat plus chrome
REMODEX	4	0,32	4	5,90	470	430			ESPRESSO plus alu
									ESPRESSO plus chrome



Produkty posiadają Atest Badań Wytrzymałościowych.

Nowy Styl zastrzega sobie prawo do zmian: konstrukcyjnych, wymiarów, terminów dostaw; usunięcia produktów i zmian w palecie wykończeń.



SZCZEGÓŁOWE WYKOŃCZENIA	TERMIN REALIZACJI	CENA MODELU W ZALEŻNOŚCI OD WYKOŃCZENIA [zł]						OFERTA
		TKANINA PODSTAWOWA (C/CU)	MICRO (M) SKAJ (V)	OBAN (EF) LUCIA (YB)	MICROFIRBA (CM) NOBLE LUX (NL) SOTI (SI)	ELEGANCE (EC) TECHNO (TCH) OXYGEN (OX)	CONTRACT (YN) NEXUS (UNY)	
DREWNO	21	254 netto 312,42 brutto						P
1.007, 1.033	7	273 netto 335,79 brutto						EX
POZOSTAŁE KOLORY DREWNA	14	273 netto 335,79 brutto						P
DREWNO	21		315 netto 387,45 brutto	322 netto 396,06 brutto	325 netto 399,75 brutto	331 netto 407,13 brutto	328 netto 403,44 brutto	P
DREWNO	21		335 netto 412,05 brutto	342 netto 420,66 brutto	347 netto 426,81 brutto	357 netto 439,11 brutto	352 netto 432,96 brutto	P
WHITE, RED, BLUE	7	230 netto 282,90 brutto						EX
PISTACHIO, SANDY BROWN, BLACK	21	230 netto 282,90 brutto						P
DREWNO	21	206 netto 253,38 brutto						P
LAMINAT	21	249 netto 306,27 brutto						P
DREWNO	14	209 netto 257,07 brutto						P
LAMINAT	21	252 netto 309,96 brutto						P
DREWNO	21		220 netto 270,60 brutto	225 netto 276,75 brutto	228 netto 280,44 brutto	235 netto 289,05 brutto	230 netto 282,90 brutto	P
LAMINAT	21		263 netto 323,49 brutto	268 netto 329,64 brutto	271 netto 333,33 brutto	278 netto 341,94 brutto	273 netto 335,79 brutto	P
DREWNO	21		223 netto 274,29 brutto	228 netto 280,44 brutto	231 netto 284,13 brutto	238 netto 292,74 brutto	234 netto 287,82 brutto	P
LAMINAT	21		266 netto 327,18 brutto	271 netto 333,33 brutto	275 netto 338,25 brutto	281 netto 345,63 brutto	277 netto 340,71 brutto	P
DREWNO	21		233 netto 286,59 brutto	243 netto 298,89 brutto	249 netto 306,27 brutto	263 netto 323,49 brutto	255 netto 313,65 brutto	P
LAMINAT	21		276 netto 339,48 brutto	286 netto 351,78 brutto	292 netto 359,16 brutto	306 netto 376,38 brutto	298 netto 366,54 brutto	P
DREWNO	21		236 netto 290,28 brutto	246 netto 302,58 brutto	252 netto 309,96 brutto	266 netto 327,18 brutto	258 netto 317,34 brutto	P
LAMINAT	21		279 netto 343,17 brutto	289 netto 355,47 brutto	296 netto 364,08 brutto	309 netto 380,07 brutto	301 netto 370,23 brutto	P

drewno: 1.007, 1.040, 1.010, 1.008, 1.016, 1.042, 1.023, 1.031, 1.033, 1.043
laminat: H1733, H3389, H3005, H3005 horizontal, H3704, W1000, U303, U630, U773, U321, U999
tworzywo sztuczne: szczegółowe wykończenia we wzorniku katalogu Kawiarnia.

oferta: P – premium, S – standard, EX – express

TERMIN REALIZACJI w dniach kalendarzowych.
ZP – ZA POTWIERDZENIEM – oznacza każdorazowe uzgadnianie terminu realizacji z Działem Handlowym.

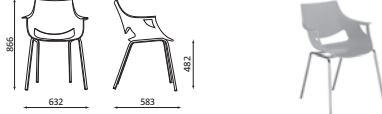
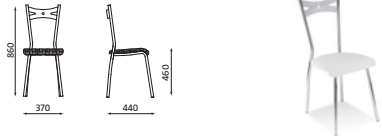
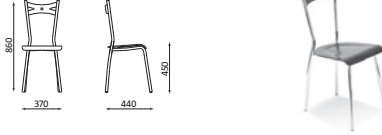

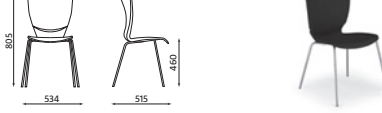
ważne informacje	składowanie w stosie max ilość [szt.]	objętość kartonu [m ³]	ilość w kartonie [szt.]	waga netto [kg]	siedzisko – szerokość [mm]	siedzisko – głębokość [mm]	MODEL wymiary w mm	2 lata na produkt GWARANCJA
 REMODEX	4	0,46	3	5,40	530	430		FANO alu
								FANO chrome
REMODEX		0,25	2	4,00	380	380		FIAMMA alu
								FIAMMA chrome
REMODEX		0,25	2	3,80	370	370		FIAMMA wood alu
								FIAMMA wood chrome
 CATAS	4	0,41	4	3,60	445	420		FIUGGI chrome







SZCZEGÓŁOWE WYKOŃCZENIA	TERMIN REALIZACJI	CENA MODELU W ZALEŻNOŚCI OD WYKOŃCZENIA [zł]						OFERTA
		TKANINA PODSTAWOWA (C/CU)	MICRO (M) SKAJ (V)	OBAN (EF) LUCIA (YB)	MICROFIRBA (CM) NOBLE LUX (NL) SOTI (SI)	ELEGANCE (EC) TECHNO (TCH) OXYGEN (OX)	CONTRACT (YN) NEXUS (UNY)	
TWORZYWO SZTUCZNE	ZP	230 netto 282,90 brutto						P
TWORZYWO SZTUCZNE	ZP	260 netto 319,80 brutto						P
	21		182 netto 223,86 brutto	188 netto 231,24 brutto	196 netto 241,08 brutto	210 netto 258,30 brutto	203 netto 249,69 brutto	P
	21		201 netto 247,23 brutto	207 netto 254,61 brutto	215 netto 264,45 brutto	229 netto 281,67 brutto	222 netto 273,06 brutto	P
DREWNO	21	203 netto 249,69 brutto						P
DREWNO	21	222 netto 273,06 brutto						P
TWORZYWO SZTUCZNE	ZP	189 netto 232,47 brutto						P

drewno: 1.007, 1.040, 1.010, 1.008, 1.016, 1.042, 1.023, 1.031, 1.033, 1.043
laminat: H1733, H3389, H3005, H3005 horizontal, H3704, W1000, U303, U630, U773, U321, U999
tworzywo sztuczne: szczegółowe wykończenia we wzorniku katalogu Kawiarnia.

oferta: P – premium, S – standard, EX – express

TERMIN REALIZACJI w dniach kalendarzowych.
ZP – ZA POTWIERDZENIEM – oznacza każdorazowe uzgadnianie terminu realizacji z Działem Handlowym.

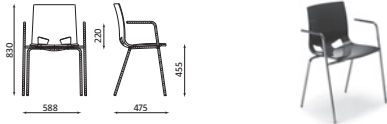

ważne informacje	składowanie w stosie max ilość [szt.]	objętość kartonu [m ³]	ilość w kartonie [szt.]	waga netto [kg]	siedzisko – szerokość [mm]	siedzisko – głębokość [mm]	MODEL wymiary w mm	
	6	0,35	4	4,60	445	410		<p>FONDO alu</p> <p>FONDO chrome</p> <p>FONDO ral 9005</p> <p>FONDO ral 2003</p> <p>FONDO ral 7016</p> <p>FONDO ral 9003</p>
	3	0,4	4	5,40	445	410		<p>FONDO ARM alu</p> <p>FONDO ARM chrome</p> <p>FONDO ARM ral 9005</p> <p>FONDO ARM ral 2003</p> <p>FONDO ARM ral 7016</p> <p>FONDO ARM ral 9003</p>





SZCZEGÓŁOWE WYKOŃCZENIA	TERMIN REALIZACJI	CENA MODELU W ZALEŻNOŚCI OD WYKOŃCZENIA [zł]						OFERTA
		TKANINA PODSTAWOWA (C/CU)	MICRO (M) SKAJ (V)	OBAN (EF) LUCIA (YB)	MICROFIRBA (CM) NOBLE LUX (NL) SOTI (SI)	ELEGANCE (EC) TECHNO (TCH) OXYGEN (OX)	CONTRACT (YN) NEXUS (UNY)	
TWORZYWO SZTUCZNE	ZP	210 netto 258,30 brutto						P
TWORZYWO SZTUCZNE	ZP	240 netto 295,20 brutto						P
GLOSS ORANGE	ZP	240 netto 295,20 brutto						P
GLOSS WHITE	ZP	240 netto 295,20 brutto						
GLOSS ORANGE	ZP	240 netto 295,20 brutto						P
GLOSS ANTHRACITE	ZP	240 netto 295,20 brutto						P
GLOSS WHITE	ZP	240 netto 295,20 brutto						P
TWORZYWO SZTUCZNE	ZP	230 netto 282,90 brutto						P
TWORZYWO SZTUCZNE	ZP	270 netto 332,10 brutto						P
GLOSS ORANGE	ZP	270 netto 332,10 brutto						P
GLOSS WHITE	ZP	270 netto 332,10 brutto						
GLOSS ORANGE	ZP	270 netto 332,10 brutto						P
GLOSS ANTHRACITE	ZP	270 netto 332,10 brutto						P
GLOSS WHITE	ZP	270 netto 332,10 brutto						P

drewno: 1.007, 1.040, 1.010, 1.008, 1.016, 1.042, 1.023, 1.031, 1.033, 1.043
laminat: H1733, H3389, H3005, H3005 horizontal, H3704, W1000, U303, U630, U773, U321, U999
tworzywo sztuczne: szczegółowe wykończenia we wzorniku katalogu Kawiarnia.

oferta: P – premium, S – standard, EX – express

TERMIN REALIZACJI w dniach kalendarzowych.
ZP – ZA POTWIERDZENIEM – oznacza każdorazowe uzgadnianie terminu realizacji z Działem Handlowym.

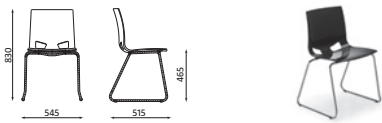
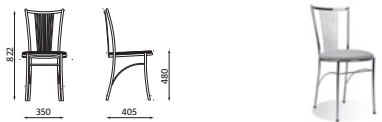
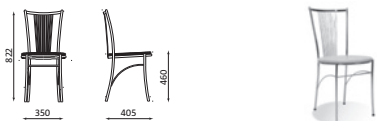

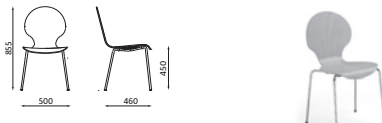
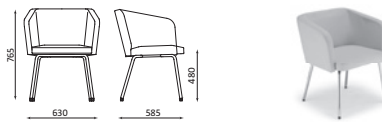
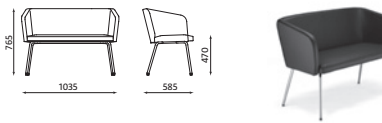
ważne informacje	składowanie w stosie max ilość [szt.]	objętość kartonu [m ³]	ilość w kartonie [szt.]	waga netto [kg]	siedzisko – szerokość [mm]	siedzisko – głębokość [mm]	MODEL	
							wymiary w mm	
 REMODEX	6	0,41	4	5,00	445	410		FONDO CFS alu
								FONDO CFS chrome
REMODEX		0,26	2	3,30	Ø410			FOSCA alu
								FOSCA chrome
REMODEX		0,26	2	3,30	Ø400			FOSCA wood alu
								FOSCA wood chrome
 REMODEX	4	0,32	4	4,90	445	415		FRAPPE alu
								FRAPPE chrome
REMODEX		0,30	1	11,80	490	450		HELLO! 4L alu
								HELLO! 4L chrome
REMODEX		0,70	1	18,00	1000	450		HELLO! 4L Duo alu
								HELLO! 4L Duo chrome





SZCZEGÓŁOWE WYKOŃCZENIA	TERMIN REALIZACJI	CENA MODELU W ZALEŻNOŚCI OD WYKOŃCZENIA [zł]						OFERTA
		TKANINA PODSTAWOWA (C/CU)	MICRO (M) SKAJ (V)	OBAN (EF) LUCIA (YB)	MICROFIRBA (CM) NOBLE LUX (NL) SOTI (SI)	ELEGANCE (EC) TECHNO (TCH) OXYGEN (OX)	CONTRACT (YN) NEXUS (UNY)	
TWORZYWO SZTUCZNE	ZP	245 netto 301,35 brutto						P
TWORZYWO SZTUCZNE	ZP	270 netto 332,10 brutto						P
	21		159 netto 195,57 brutto	162 netto 199,26 brutto	167 netto 205,41 brutto	173 netto 212,79 brutto	171 netto 210,33 brutto	P
	14		165 netto 202,95 brutto	168 netto 206,64 brutto	173 netto 212,79 brutto	179 netto 220,17 brutto	177 netto 217,71 brutto	P
DREWNO	21	182 netto 223,86 brutto						P
DREWNO	14	188 netto 231,24 brutto						P
DREWNO	21	206 netto 253,38 brutto						P
LAMINAT	21	249 netto 306,27 brutto						
1.007, 1.010, 1.033	7	209 netto 257,07 brutto						EX
POZOSTAŁE KOLORY DREWNA	14	209 netto 257,07 brutto						P
LAMINAT	21	252 netto 309,96 brutto						P
	21		569 netto 699,87 brutto			739 netto 908,97 brutto	686 netto 843,78 brutto	P
	21		592 netto 728,16 brutto			762 netto 937,26 brutto	709 netto 872,07 brutto	P
	21		827 netto 1017,21 brutto			1046 netto 1286,58 brutto	994 netto 1222,62 brutto	P
	21		858 netto 1055,34 brutto			1078 netto 1325,94 brutto	1025 netto 1260,75 brutto	P

drewno: 1.007, 1.040, 1.010, 1.008, 1.016, 1.042, 1.023, 1.031, 1.033, 1.043
laminat: H1733, H3389, H3005, H3005 horizontal, H3704, W1000, U303, U630, U773, U321, U999
tworzywo sztuczne: szczegółowe wykończenia we wzorniku katalogu Kawiarnia.

oferta: P – premium, S – standard, EX – express

TERMIN REALIZACJI w dniach kalendarzowych.
ZP – ZA POTWIERDZENIEM – oznacza każdorazowe uzgadnianie terminu realizacji z Działem Handlowym.

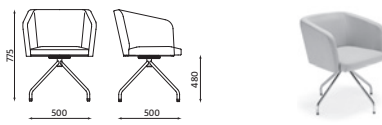
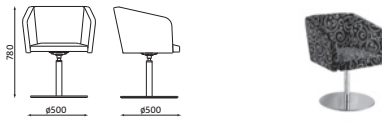

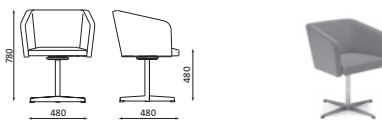
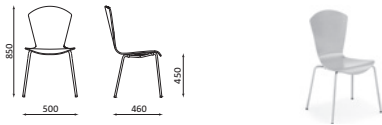
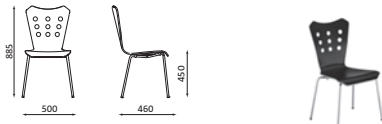
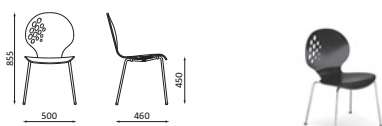
ważne informacje	składowanie w stosie max ilość [szt.]	objętość kartonu [m ³]	ilość w kartonie [szt.]	waga netto [kg]	siedzisko – szerokość [mm]	siedzisko – głębokość [mm]	MODEL		
							wymiary w mm		
REMODEX		0,30	1	14,50	490	450		HELLO! 4S alu	
								HELLO! 4S chrome	
REMODEX		0,32	1	24,80	490	450		HELLO! 1S chrome	
 REMODEX		0,32	1	28,3	490	450		HELLO! 1S CROSS chrome	
REMODEX	4	0,32	4	4,70	455	460		INABA alu	
								INABA chrome	
REMODEX	4	0,34	4	4,90	440	460		KLIWIA alu	
								KLIWIA chrome	
REMODEX	4	0,38	4	4,90	470	430		LAKKA alu	
								LAKKA chrome	













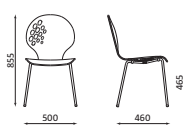

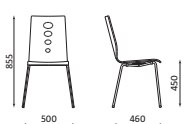
SZCZEGÓŁOWE WYKOŃCZENIA	TERMIN REALIZACJI	CENA MODELU W ZALEŻNOŚCI OD WYKOŃCZENIA [zł]						OFERTA
		TKANINA PODSTAWOWA (C/CU)	MICRO (M) SKAJ (V)	OBAN (EF) LUCIA (YB)	MICROFIRBA (CM) NOBLE LUX (NL) SOTI (SI)	ELEGANCE (EC) TECHNO (TCH) OXYGEN (OX)	CONTRACT (YN) NEXUS (UNY)	
	21		659 netto 810,57 brutto			828 netto 1018,44 brutto	775 netto 953,25 brutto	P
	21		682 netto 838,86 brutto			852 netto 1047,96 brutto	800 netto 984,00 brutto	P
	21		1057 netto 1300,11 brutto			1227 netto 1509,21 brutto	1174 netto 1444,02 brutto	P
	21		746 netto 917,58 brutto			956 netto 1175,88 brutto	903 netto 1110,69 brutto	P
DREWNO	21					206 netto 253,38 brutto		P
LAMINAT	21					249 netto 306,27 brutto		P
DREWNO	21					209 netto 257,07 brutto		P
LAMINAT	21					252 netto 309,96 brutto		P
DREWNO	21					235 netto 289,05 brutto		P
LAMINAT	21					294 netto 361,62 brutto		P
DREWNO	21					238 netto 292,74 brutto		P
LAMINAT	21					298 netto 366,54 brutto		P
DREWNO	21					235 netto 289,05 brutto		P
LAMINAT	21					294 netto 361,62 brutto		P
DREWNO	21					238 netto 292,74 brutto		P
LAMINAT	21					298 netto 366,54 brutto		P

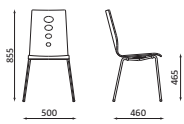
drewno: 1.007, 1.040, 1.010, 1.008, 1.016, 1.042, 1.023, 1.031, 1.033, 1.043
 laminat: H1733, H3389, H3005, H3005 horizontal, H3704, W1000, U303, U630, U773, U321, U999
 tworzywo sztuczne: szczegółowe wykończenia we wzorniku katalogu Kawiarnia.

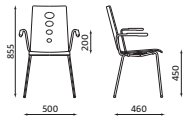
oferta: P – premium, S – standard, EX – express

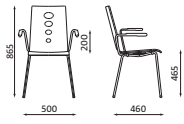
TERMIN REALIZACJI w dniach kalendarzowych.
 ZP – ZA POTWIERDZENIEM – oznacza każdorazowe uzgadnianie terminu realizacji z Działem Handlowym.

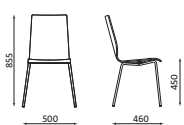

ważne informacje	składowanie w stosie max ilość [szt.]	objętość kartonu [m ³]	ilość w kartonie [szt.]	waga netto [kg]	siedzisko – szerokość [mm]	siedzisko – głębokość [mm]	MODEL		
							wymiary w mm		
REMODEX	4	0,38	4	4,90	470	430			LAKKA seat plus alu
									LAKKA seat plus chrome
REMODEX	4	0,32	4	4,90	395	415			LANTANA alu
									LANTANA chrome
REMODEX	4	0,32	4	4,90	395	425			LANTANA seat plus alu
									LANTANA seat plus chrome
REMODEX	4	0,34	4	5,80	395	415			LANTANA ARM alu
									LANTANA ARM chrome
REMODEX	4	0,34	4	5,80	395	425			LANTANA ARM seat plus alu
									LANTANA ARM seat plus chrome
REMODEX	4	0,32	4	4,90	395	425			LATTE alu
									LATTE chrome



Produkty posiadają Atest Badań Wytrzymałościowych.

Nowy Styl zastrzega sobie prawo do zmian: konstrukcyjnych, wymiarów, terminów dostaw; usunięcia produktów i zmian w paletce wykończeń.











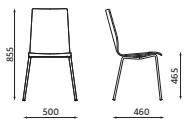

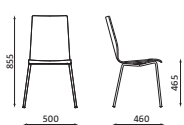

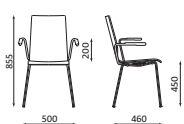
SZCZEGÓŁOWE WYKOŃCZENIA	TERMIN REALIZACJI	CENA MODELU W ZALEŻNOŚCI OD WYKOŃCZENIA [zł]						OFERTA
		TKANINA PODSTAWOWA (C/CU)	MICRO (M) SKAJ (V)	OBAN (EF) LUCIA (YB)	MICROFIRBA (CM) NOBLE LUX (NL) SOTI (SI)	ELEGANCE (EC) TECHNO (TCH) OXYGEN (OX)	CONTRACT (YN) NEXUS (UNY)	
DREWNO	21		248 netto 305,04 brutto	254 netto 312,42 brutto	257 netto 316,11 brutto	263 netto 323,49 brutto	259 netto 318,57 brutto	P
LAMINAT	21		308 netto 378,84 brutto	313 netto 384,99 brutto	317 netto 389,91 brutto	323 netto 397,29 brutto	319 netto 392,37 brutto	P
DREWNO	21		251 netto 308,73 brutto	257 netto 316,11 brutto	260 netto 319,80 brutto	266 netto 327,18 brutto	262 netto 322,26 brutto	P
LAMINAT	21		311 netto 382,53 brutto	317 netto 389,91 brutto	320 netto 393,60 brutto	326 netto 400,98 brutto	322 netto 396,06 brutto	P
DREWNO	21		235 netto 289,05 brutto					P
LAMINAT	21		294 netto 361,62 brutto					P
DREWNO	21		238 netto 292,74 brutto					P
LAMINAT	21		298 netto 366,54 brutto					P
DREWNO	21		248 netto 305,04 brutto	254 netto 312,42 brutto	257 netto 316,11 brutto	263 netto 323,49 brutto	259 netto 318,57 brutto	P
LAMINAT	21		308 netto 378,84 brutto	313 netto 384,99 brutto	317 netto 389,91 brutto	323 netto 397,29 brutto	319 netto 392,37 brutto	P
DREWNO	21		251 netto 308,73 brutto	257 netto 316,11 brutto	260 netto 319,80 brutto	266 netto 327,18 brutto	262 netto 322,26 brutto	P
LAMINAT	21		311 netto 382,53 brutto	317 netto 389,91 brutto	320 netto 393,60 brutto	326 netto 400,98 brutto	322 netto 396,06 brutto	P
DREWNO	21		301 netto 370,23 brutto					P
LAMINAT	21		361 netto 444,03 brutto					P
DREWNO	21		304 netto 373,92 brutto					P
LAMINAT	21		364 netto 447,72 brutto					P
DREWNO	21		314 netto 386,22 brutto	320 netto 393,60 brutto	323 netto 397,29 brutto	329 netto 404,67 brutto	325 netto 399,75 brutto	P
LAMINAT	21		374 netto 460,02 brutto	380 netto 467,40 brutto	383 netto 471,09 brutto	389 netto 478,47 brutto	385 netto 473,55 brutto	P
DREWNO	21		318 netto 391,14 brutto	323 netto 397,29 brutto	326 netto 400,98 brutto	332 netto 408,36 brutto	328 netto 403,44 brutto	P
LAMINAT	21		377 netto 463,71 brutto	383 netto 471,09 brutto	386 netto 474,78 brutto	392 netto 482,16 brutto	388 netto 477,24 brutto	P
DREWNO	21		206 netto 253,38 brutto					P
LAMINAT	21		249 netto 306,27 brutto					P
1.007, 1.010, 1.033	7		209 netto 257,07 brutto					EX
POZOSTAŁE KOLORY DREWNA	14		209 netto 257,07 brutto					P
LAMINAT	21		252 netto 309,96 brutto					P

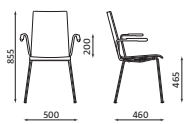
drewno: 1.007, 1.040, 1.010, 1.008, 1.016, 1.042, 1.023, 1.031, 1.033, 1.043
 laminat: H1733, H3389, H3005, H3005 horizontal, H3704, W1000, U303, U630, U773, U321, U999
 tworzywo sztuczne: szczegółowe wykończenia we wzorniku katalogu Kawiarnia.

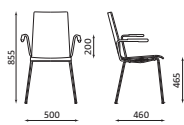
oferta: P – premium, S – standard, EX – express

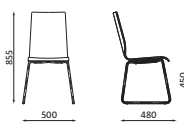
TERMIN REALIZACJI w dniach kalendarzowych.
 ZP – ZA POTWIERDZENIEM – oznacza każdorazowe uzgadnianie terminu realizacji z Działem Handlowym.

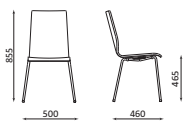

ważne informacje	składowanie w stosie max ilość [szt.]	objętość kartonu [m ³]	ilość w kartonie [szt.]	waga netto [kg]	siedzisko – szerokość [mm]	siedzisko – głębokość [mm]	MODEL		
							wymiary w mm		
REMODEX	4	0,32	4	5,35	395	425			LATTE seat plus alu
									LATTE seat plus chrome
REMODEX	4	0,32	4	5,80	395	425			LATTE plus alu
									LATTE plus chrome
REMODEX	4	0,34	4	5,80	395	425			LATTE ARM alu
									LATTE ARM chrome
REMODEX	4	0,34	4	5,80	395	425			LATTE ARM seat plus alu
									LATTE ARM seat plus chrome
REMODEX	4	0,34	4	5,80	395	425			LATTE ARM plus alu
									LATTE ARM plus chrome
		0,36	2	4,90	395	425			LATTE CFS alu
									LATTE CFS chrome
REMODEX		0,32	2	5,20	395	425			LATTE A PLUS alu
									LATTE A PLUS chrome







SZCZEGÓŁOWE WYKOŃCZENIA	TERMIN REALIZACJI	CENA MODELU W ZALEŻNOŚCI OD WYKOŃCZENIA [zł]						OFERTA	
		TKANINA PODSTAWOWA (C/CU)	MICRO (M) SKAJ (V)	OBAN (EF) LUCIA (YB)	MICROFIRBA (CM) NOBLE LUX (NL) SOTI (SI)	ELEGANCE (EC) TECHNO (TCH) OXYGEN (OX)	CONTRACT (YN) NEXUS (UNY)		
DREWNO	21		220 netto 270,60 brutto	225 netto 276,75 brutto	228 netto 280,44 brutto	235 netto 289,05 brutto	230 netto 282,90 brutto	P	
LAMINAT	21		263 netto 323,49 brutto	268 netto 329,64 brutto	271 netto 333,33 brutto	278 netto 341,94 brutto	273 netto 335,79 brutto	P	
DREWNO	21		223 netto 274,29 brutto	228 netto 280,44 brutto	231 netto 284,13 brutto	238 netto 292,74 brutto	234 netto 287,82 brutto	P	
LAMINAT	21		266 netto 327,18 brutto	271 netto 333,33 brutto	275 netto 338,25 brutto	281 netto 345,63 brutto	277 netto 340,71 brutto	P	
DREWNO	21		233 netto 286,59 brutto	243 netto 298,89 brutto	249 netto 306,27 brutto	263 netto 323,49 brutto	255 netto 313,65 brutto	P	
LAMINAT	21		276 netto 339,48 brutto	286 netto 351,78 brutto	292 netto 359,16 brutto	306 netto 376,38 brutto	298 netto 366,54 brutto	P	
DREWNO	21		236 netto 290,28 brutto	246 netto 302,58 brutto	252 netto 309,96 brutto	266 netto 327,18 brutto	258 netto 317,34 brutto	P	
LAMINAT	21		279 netto 343,17 brutto	289 netto 355,47 brutto	296 netto 364,08 brutto	309 netto 380,07 brutto	301 netto 370,23 brutto	P	
DREWNO	21		272 netto 334,56 brutto						P
LAMINAT	21		315 netto 387,45 brutto						P
DREWNO	14		276 netto 339,48 brutto						P
LAMINAT	21		319 netto 392,37 brutto						P
DREWNO	21		286 netto 351,78 brutto	291 netto 357,93 brutto	294 netto 361,62 brutto	301 netto 370,23 brutto	297 netto 365,31 brutto	P	
LAMINAT	21		329 netto 404,67 brutto	334 netto 410,82 brutto	338 netto 415,74 brutto	344 netto 423,12 brutto	340 netto 418,20 brutto	P	
DREWNO	21		289 netto 355,47 brutto	294 netto 361,62 brutto	298 netto 366,54 brutto	304 netto 373,92 brutto	300 netto 369,00 brutto	P	
LAMINAT	21		332 netto 408,36 brutto	338 netto 415,74 brutto	341 netto 419,43 brutto	347 netto 426,81 brutto	343 netto 421,89 brutto	P	
DREWNO	21		299 netto 367,77 brutto	309 netto 380,07 brutto	315 netto 387,45 brutto	329 netto 404,67 brutto	321 netto 394,83 brutto	P	
LAMINAT	21		342 netto 420,66 brutto	352 netto 432,96 brutto	359 netto 441,57 brutto	372 netto 457,56 brutto	364 netto 447,72 brutto	P	
DREWNO	14		302 netto 371,46 brutto	312 netto 383,76 brutto	319 netto 392,37 brutto	332 netto 408,36 brutto	324 netto 398,52 brutto	P	
LAMINAT	21		345 netto 424,35 brutto	355 netto 436,65 brutto	362 netto 445,26 brutto	375 netto 461,25 brutto	367 netto 451,41 brutto	P	
DREWNO	21		215 netto 264,45 brutto						P
LAMINAT	21		258 netto 317,34 brutto						P
DREWNO	14		225 netto 276,75 brutto						P
LAMINAT	21		268 netto 329,64 brutto						P
	21		199 netto 244,77 brutto	tylko w YB 210 netto 258,30 brutto		261 netto 321,03 brutto	244 netto 300,12 brutto	P	
	21		202 netto 248,46 brutto	tylko w YB 214 netto 263,22 brutto		264 netto 324,72 brutto	247 netto 303,81 brutto	P	

drewno: 1.007, 1.040, 1.010, 1.008, 1.016, 1.042, 1.023, 1.031, 1.033, 1.043
laminat: H1733, H3389, H3005, H3005 horizontal, H3704, W1000, U303, U630, U773, U321, U999
tworzywo sztuczne: szczegółowe wykończenia we wzorniku katalogu Kawiarnia.

oferta: P – premium, S – standard, EX – express

TERMIN REALIZACJI w dniach kalendarzowych.
ZP – ZA POTWIERDZENIEM – oznacza każdorazowe uzgadnianie terminu realizacji z Działem Handlowym.

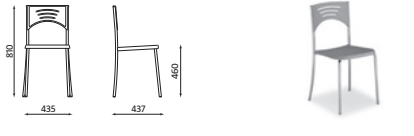

ważne informacje	składowanie w stosie max ilość [szt.]	objętość kartonu [m ³]	ilość w kartonie [szt.]	waga netto [kg]	siedzisko – szerokość [mm]	siedzisko – głębokość [mm]	MODEL wymiary w mm	
REMODEX		0,32	2	6,20	395	425		LATTE B PLUS alu LATTE B PLUS chrome
REMODEX		0,32	2	7,10	395	425		LATTE B PLUS ARM alu LATTE B PLUS ARM chrome
REMODEX		0,32	2	6,50	395	425		LATTE B PLUS SQ alu LATTE B PLUS SQ chrome
	10	0,25	4	3,10	435	420		LULA chrome













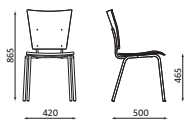

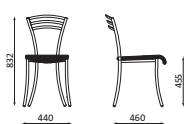

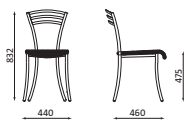
SZCZEGÓŁOWE WYKOŃCZENIA	TERMIN REALIZACJI	CENA MODELU W ZALEŻNOŚCI OD WYKOŃCZENIA [zł]						OFERTA
		TKANINA PODSTAWOWA (C/CU)	MICRO (M) SKAJ (V)	OBAN (EF) LUCIA (YB)	MICROFIRBA (CM) NOBLE LUX (NL) SOTI (SI)	ELEGANCE (EC) TECHNO (TCH) OXYGEN (OX)	CONTRACT (YN) NEXUS (UNY)	
DREWNO	21		289 netto 355,47 brutto	tylko w YB 294 netto 361,62 brutto		334 netto 410,82 brutto	303 netto 372,69 brutto	P
LAMINAT	21		332 netto 408,36 brutto	tylko w YB 338 netto 415,74 brutto		377 netto 463,71 brutto	346 netto 425,58 brutto	P
DREWNO	21		292 netto 359,16 brutto	tylko w YB 298 netto 366,54 brutto		338 netto 415,74 brutto	306 netto 376,38 brutto	P
LAMINAT	21		335 netto 412,05 brutto	tylko w YB 341 netto 419,43 brutto		381 netto 468,63 brutto	349 netto 429,27 brutto	P
DREWNO	21		355 netto 436,65 brutto	tylko w YB 361 netto 444,03 brutto		401 netto 493,23 brutto	369 netto 453,87 brutto	P
LAMINAT	21		398 netto 489,54 brutto	tylko w YB 404 netto 496,92 brutto		444 netto 546,12 brutto	412 netto 506,76 brutto	P
1.007, 1.010, 1.033	7	tylko w YB 130, YB 026, YB 009, YB 105 364 netto 447,72 brutto						EX
1.033	5	tylko w YB 130 364 netto 447,72 brutto						EX
POZOSTAŁE KOLORY DREWNA	21		359 netto 441,57 brutto	tylko w YB 364 netto 447,72 brutto		404 netto 496,92 brutto	372 netto 457,56 brutto	P
LAMINAT	21		402 netto 494,46 brutto	tylko w YB 407 netto 500,61 brutto		447 netto 549,81 brutto	415 netto 510,45 brutto	P
DREWNO	21		351 netto 431,73 brutto	tylko w YB 356 netto 437,88 brutto		396 netto 487,08 brutto	365 netto 448,95 brutto	P
LAMINAT	21		394 netto 484,62 brutto	tylko w YB 399 netto 490,77 brutto		439 netto 539,97 brutto	408 netto 501,84 brutto	P
DREWNO	21		398 netto 489,54 brutto	tylko w YB 404 netto 496,92 brutto		444 netto 546,12 brutto	412 netto 506,76 brutto	P
LAMINAT	21		441 netto 542,43 brutto	tylko w YB 447 netto 549,81 brutto		487 netto 599,01 brutto	455 netto 559,65 brutto	P
TWORZYWO SZTUCZNE	ZP	144 netto 177,12 brutto						P

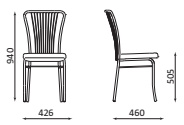
drewno: 1.007, 1.040, 1.010, 1.008, 1.016, 1.042, 1.023, 1.031, 1.033, 1.043
laminat: H1733, H3389, H3005, H3005 horizontal, H3704, W1000, U303, U630, U773, U321, U999
tworzywo sztuczne: szczegółowe wykończenia we wzorniku katalogu Kawiarnia.

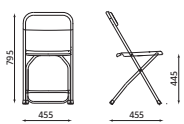
oferta: P – premium, S – standard, EX – express

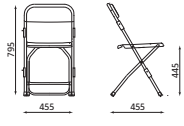
TERMIN REALIZACJI w dniach kalendarzowych.
ZP – ZA POTWIERDZENIEM – oznacza każdorazowe uzgadnianie terminu realizacji z Działem Handlowym.

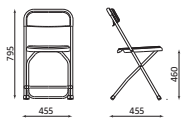

ważne informacje	składowanie w stosie max ilość [szt.]	objętość kartonu [m ³]	ilość w kartonie [szt.]	waga netto [kg]	siedzisko – szerokość [mm]	siedzisko – głębokość [mm]	MODEL		
							wymiary w mm		
REMODEX	3	0,39	4	5,90	440	435			MEDEA alu
									MEDEA chrome
REMODEX		0,29	2	4,40	395	415			MOLINO wood alu
									MOLINO wood chrome
REMODEX		0,30	2	4,55	400	415			MOLINO plus alu
									MOLINO plus chrome
REMODEX		0,32	2	5,30	425	425			NERON alu
									NERON chrome
REMODEX	20 po złożeniu	0,09	5	3,40	400	400			POLYFOLD alu
REMODEX	20 po złożeniu	0,09	5	3,40	400	400			POLYFOLD click alu
REMODEX	20 po złożeniu	0,09	5	4,50	400	400			POLYFOLD plus alu













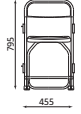

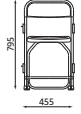



SZCZEGÓŁOWE WYKOŃCZENIA	TERMIN REALIZACJI	CENA MODELU W ZALEŻNOŚCI OD WYKOŃCZENIA [zł]						OFERTA
		TKANINA PODSTAWOWA (C/CU)	MICRO (M) SKAJ (V)	OBAN (EF) LUCIA (YB)	MICROFIRBA (CM) NOBLE LUX (NL) SOTI (SI)	ELEGANCE (EC) TECHNO (TCH) OXYGEN (OX)	CONTRACT (YN) NEXUS (UNY)	
DREWNO	21	237 netto 291,51 brutto						P
DREWNO	14	248 netto 305,04 brutto						P
DREWNO	21	200 netto 246,00 brutto						P
DREWNO	14	216 netto 265,68 brutto						P
	21		179 netto 220,17 brutto	186 netto 228,78 brutto	195 netto 239,85 brutto	210 netto 258,30 brutto	202 netto 248,46 brutto	P
	21		196 netto 241,08 brutto	202 netto 248,46 brutto	210 netto 258,30 brutto	225 netto 276,75 brutto	218 netto 268,14 brutto	P
	21	129 netto 158,67 brutto	129 netto 158,67 brutto					S
	14	138 netto 169,74 brutto	138 netto 169,74 brutto					S
	7	tylko w V-18N, V-46, V-17, V-49, V-51, V-82, V-98 138 netto 169,74 brutto						EX
K02, K05, K30, K31, K36, K51, K53, K59	14	78 netto 95,94 brutto						S
K02, K05, K30, K31, K36, K51, K53, K59	14	86 netto 105,78 brutto						S
K02, K05, K31, K59, K51, K30 TK02, TK05, TK31, TK59, TK51, TK30	14	115 netto 141,45 brutto						S

drewno: 1.007, 1.040, 1.010, 1.008, 1.016, 1.042, 1.023, 1.031, 1.033, 1.043
laminat: H1733, H3389, H3005, H3005 horizontal, H3704, W1000, U303, U630, U773, U321, U999
tworzywo sztuczne: szczegółowe wykończenia we wzorniku katalogu Kawiarnia.

oferta: P – premium, S – standard, EX – express

TERMIN REALIZACJI w dniach kalendarzowych.
ZP – ZA POTWIERDZENIEM – oznacza każdorazowe uzgadnianie terminu realizacji z Działem Handlowym.

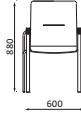

ważne informacje	składowanie w stosie max ilość [szt.]	objętość kartonu [m ³]	ilość w kartonie [szt.]	waga netto [kg]	siedzisko – szerokość [mm]	siedzisko – głębokość [mm]	MODEL wymiary w mm			
										
REMODEX	20 po złożeniu	0,09	5	4,50	400	400				POLYFOLD plus click alu
REMODEX	4	0,38	4	4,90	470	430				ROSA alu
										ROSA chrome
REMODEX	4	0,38	4	4,90	470	430				ROSA seat plus alu
										ROSA seat plus chrome
REMODEX		0,26	2	4,80	Ø 375					ROSSO alu
										ROSSO chrome
REMODEX	4	0,36	2	8,00	460	460				SAMBA alu
										SAMBA kwarc
										SAMBA chrome







SZCZEGÓŁOWE WYKOŃCZENIA	TERMIN REALIZACJI	CENA MODELU W ZALEŻNOŚCI OD WYKOŃCZENIA [zł]						OFERTA
		TKANINA PODSTAWOWA (C/CU)	MICRO (M) SKAJ (V)	OBAN (EF) LUCIA (YB)	MICROFIRBA (CM) NOBLE LUX (NL) SOTI (SI)	ELEGANCE (EC) TECHNO (TCH) OXYGEN (OX)	CONTRACT (YN) NEXUS (UNY)	
K02, K05, K31, K59, K51, K30 TK02, TK05, TK31, TK59, TK51, TK30	14	122 netto 150,06 brutto						S
DREWNO	21	235 netto 289,05 brutto						P
LAMINAT	21	294 netto 361,62 brutto						P
DREWNO	21	238 netto 292,74 brutto						P
LAMINAT	21	298 netto 366,54 brutto						P
DREWNO	21		248 netto 305,04 brutto	254 netto 312,42 brutto	257 netto 316,11 brutto	263 netto 323,49 brutto	259 netto 318,57 brutto	P
LAMINAT	21		308 netto 378,84 brutto	313 netto 384,99 brutto	317 netto 389,91 brutto	323 netto 397,29 brutto	319 netto 392,37 brutto	P
DREWNO	21		251 netto 308,73 brutto	257 netto 316,11 brutto	260 netto 319,80 brutto	266 netto 327,18 brutto	262 netto 322,26 brutto	P
LAMINAT	21		311 netto 382,53 brutto	317 netto 389,91 brutto	320 netto 393,60 brutto	326 netto 400,98 brutto	322 netto 396,06 brutto	P
	21	163 netto 200,49 brutto	163 netto 200,49 brutto					S
	14	182 netto 223,86 brutto	182 netto 223,86 brutto					S
	21		254 netto 312,42 brutto	278 netto 341,94 brutto	tylko w SI 310 netto 381,30 brutto	389 netto 478,47 brutto	347 netto 426,81 brutto	P
	7	tylko w V-46, V-17, V-49, V-04, V-82, V-98, nakładki na podłokietniki w kolorze 1.007, 1.010, 1.033, 1.008 254 netto 312,42 brutto						EX
	7	tylko w V-46, V-17, V-49, V-04, V-82, V-98, nakładki na podłokietniki w kolorze 1.007, 1.010, 1.033, 1.008 263 netto 323,49 brutto						EX
	5	tylko w V-17, V-04, nakładki na podłokietniki w kolorze 1.008 263 netto 323,49 brutto						EX
	14		263 netto 323,49 brutto	289 netto 355,47 brutto	tylko w SI 322 netto 396,06 brutto	402 netto 494,46 brutto	360 netto 442,80 brutto	P

drewno: 1.007, 1.040, 1.010, 1.008, 1.016, 1.042, 1.023, 1.031, 1.033, 1.043
laminat: H1733, H3389, H3005, H3005 horizontal, H3704, W1000, U303, U630, U773, U321, U999
tworzywo sztuczne: szczegółowe wykończenia we wzorniku katalogu Kawiarnia.

oferta: P – premium, S – standard, EX – express

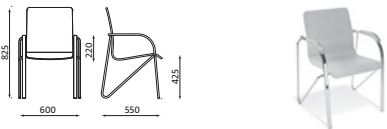
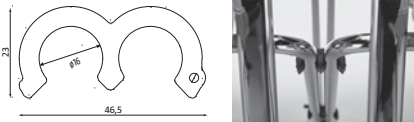
TERMIN REALIZACJI w dniach kalendarzowych.
ZP – ZA POTWIERDZENIEM – oznacza każdorazowe uzgadnianie terminu realizacji z Działem Handlowym.

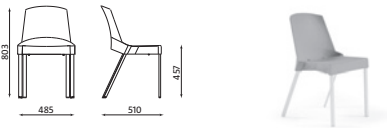

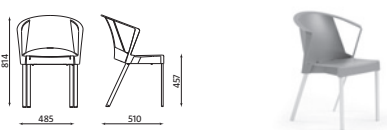
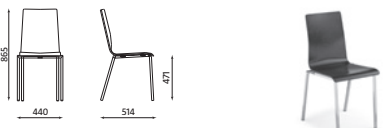
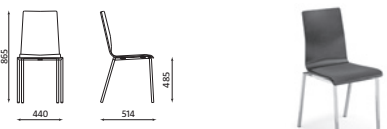
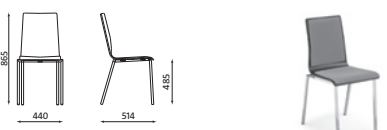
ważne informacje	składowanie w stosie max ilość [szt.]	objętość kartonu [m ³]	ilość w kartonie [szt.]	waga netto [kg]	siedzisko – szerokość [mm]	siedzisko – głębokość [mm]	MODEL wymiary w mm	
REMODEX	4	0,36	2	8,00	445	460		SAMBA wood alu
								SAMBA wood chrome
								SAMBA LINK do połączenia tylnych nóg w 2 punktach (2 szt. w komplecie)
	6	0,48	4	3,30	485	430		SOLEIL aluminium
	6	0,48	4	3,45	485	430		SOLEIL ARM aluminium
REMODEX	8	0,32	4	5,30	395	425		SQUERTO alu
								SQUERTO chrome
REMODEX	8	0,32	4	5,30	395	425		SQUERTO seat plus alu
								SQUERTO seat plus chrome
REMODEX	8	0,32	4	5,30	395	425		SQUERTO plus alu
								SQUERTO plus chrome



SZCZEGÓŁOWE WYKOŃCZENIA	TERMIN REALIZACJI	CENA MODELU W ZALEŻNOŚCI OD WYKOŃCZENIA [zł]						OFERTA
		TKANINA PODSTAWOWA (C/CU)	MICRO (M) SKAJ (V)	OBAN (EF) LUCIA (YB)	MICROFIRBA (CM) NOBLE LUX (NL) SOTI (SI)	ELEGANCE (EC) TECHNO (TCH) OXYGEN (OX)	CONTRACT (YN) NEXUS (UNY)	
DREWNO	21	306 netto 376,38 brutto						P
DREWNO	14	317 netto 389,91 brutto						P
	14	9 netto 11,07 brutto						P
TWORZYWO SZTUCZNE	ZP	226 netto 277,98 brutto						P
TWORZYWO SZTUCZNE	ZP	242 netto 297,66 brutto						P
DREWNO	21	268 netto 329,64 brutto						P
LAMINAT	21	311 netto 382,53 brutto						P
DREWNO	14	315 netto 387,45 brutto						P
LAMINAT	21	359 netto 441,57 brutto						P
DREWNO	21		282 netto 346,86 brutto	287 netto 353,01 brutto	290 netto 356,70 brutto	297 netto 365,31 brutto	292 netto 359,16 brutto	P
LAMINAT	21		325 netto 399,75 brutto	330 netto 405,90 brutto	333 netto 409,59 brutto	340 netto 418,20 brutto	335 netto 412,05 brutto	P
DREWNO	21		329 netto 404,67 brutto	334 netto 410,82 brutto	338 netto 415,74 brutto	344 netto 423,12 brutto	340 netto 418,20 brutto	P
LAMINAT	21		372 netto 457,56 brutto	377 netto 463,71 brutto	381 netto 468,63 brutto	406 netto 499,38 brutto	383 netto 471,09 brutto	P
DREWNO	21		294 netto 361,62 brutto	305 netto 375,15 brutto	311 netto 382,53 brutto	325 netto 399,75 brutto	317 netto 389,91 brutto	P
LAMINAT	21		338 netto 415,74 brutto	348 netto 428,04 brutto	354 netto 435,42 brutto	368 netto 452,64 brutto	360 netto 442,80 brutto	P
DREWNO	21		342 netto 420,66 brutto	352 netto 432,96 brutto	359 netto 441,57 brutto	372 netto 457,56 brutto	364 netto 447,72 brutto	P
LAMINAT	21		385 netto 473,55 brutto	395 netto 485,85 brutto	402 netto 494,46 brutto	415 netto 510,45 brutto	407 netto 500,61 brutto	P

drewno: 1.007, 1.040, 1.010, 1.008, 1.016, 1.042, 1.023, 1.031, 1.033, 1.043
laminat: H1733, H3389, H3005, H3005 horizontal, H3704, W1000, U303, U630, U773, U321, U999
tworzywo sztuczne: szczegółowe wykończenia we wzorniku katalogu Kawiarnia.

oferta: P – premium, S – standard, EX – express

TERMIN REALIZACJI w dniach kalendarzowych.
ZP – ZA POTWIERDZENIEM – oznacza każdorazowe uzgadnianie terminu realizacji z Działem Handlowym.

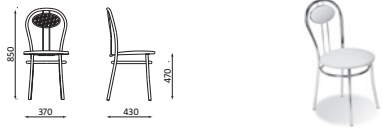
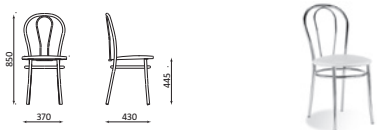
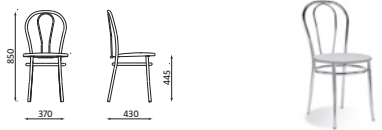
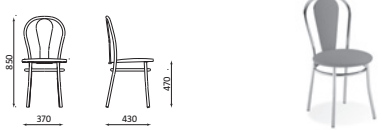

ważne informacje	składowanie w stosie max ilość [szt.]	objętość kartonu [m ³]	ilość w kartonie [szt.]	waga netto [kg]	siedzisko – szerokość [mm]	siedzisko – głębokość [mm]	MODEL wymiary w mm	
REMODEX		0,25	2	4,45	Ø 410			<p>TIZIANO alu</p> <p>TIZIANO chrome</p>
REMODEX		0,26	2	5,17	Ø 410			<p>TULIPAN alu</p> <p>TULIPAN black</p> <p>TULIPAN chrome</p>
REMODEX		0,26	2	4,20	Ø 400			<p>TULIPAN wood alu</p> <p>TULIPAN wood black</p> <p>TULIPAN wood chrome</p>
REMODEX		0,26	2	5,30	Ø 410			<p>TULIPAN PLUS alu</p> <p>TULIPAN PLUS chrome</p>



Produkty posiadają Atest Badań Wytrzymałościowych.

Nowy Styl zastrzega sobie prawo do zmian: konstrukcyjnych, wymiarów, terminów dostaw; usunięcia produktów i zmian w palecie wykończeń.





SZCZEGÓŁOWE WYKOŃCZENIA	TERMIN REALIZACJI	CENA MODELU W ZALEŻNOŚCI OD WYKOŃCZENIA [zł]						OFERTA
		TKANINA PODSTAWOWA (C/CU)	MICRO (M) SKAJ (V)	OBAN (EF) LUCIA (YB)	MICROFIRBA (CM) NOBLE LUX (NL) SOTI (SI)	ELEGANCE (EC) TECHNO (TCH) OXYGEN (OX)	CONTRACT (YN) NEXUS (UNY)	
	21		130 netto 159,90 brutto	146 netto 179,58 brutto	153 netto 188,19 brutto			P
	7	tylko w V-18N, V-46, V-17, V-49, V-51, V-82, V-98 140 netto 172,20 brutto						EX
	14		140 netto 172,20 brutto	158 netto 194,34 brutto	163 netto 200,49 brutto			P
	21	97 netto 119,31 brutto	97 netto 119,31 brutto					S
	ZP	93 netto 114,39 brutto	93 netto 114,39 brutto					S
	14	101 netto 124,23 brutto	101 netto 124,23 brutto					S
1.007, 1.008, 1.010, 1.031	21	133 netto 163,59 brutto						S
1.007, 1.008, 1.010, 1.031	ZP	125 netto 153,75 brutto						S
1.007, 1.008, 1.010, 1.031	14	138 netto 169,74 brutto						S
	21	130 netto 159,90 brutto	130 netto 159,90 brutto	tylko w EF 139 netto 170,97 brutto				S
	7	tylko w V-18N, V-46, V-17, V-49, V-51, V-82, V-98 139 netto 170,97 brutto						EX
	14	139 netto 170,97 brutto	139 netto 170,97 brutto	tylko w EF 147 netto 180,81 brutto				S

drewno: 1.007, 1.040, 1.010, 1.008, 1.016, 1.042, 1.023, 1.031, 1.033, 1.043
laminat: H1733, H3389, H3005, H3005 horizontal, H3704, W1000, U303, U630, U773, U321, U999
tworzywo sztuczne: szczegółowe wykończenia we wzorniku katalogu Kawiarnia.

oferta: P – premium, S – standard, EX – express

TERMIN REALIZACJI w dniach kalendarzowych.
ZP – ZA POTWIERDZENIEM – oznacza każdorazowe uzgadnianie terminu realizacji z Działem Handlowym.

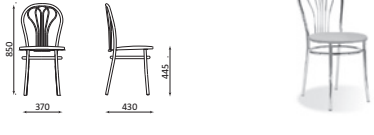

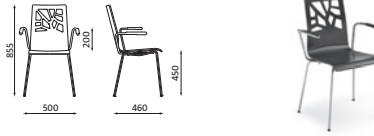
ważne informacje	składowanie w stosie max ilość [szt.]	objętość kartonu [m ³]	ilość w kartonie [szt.]	waga netto [kg]	siedzisko – szerokość [mm]	siedzisko – głębokość [mm]	MODEL		wymary w mm		
REMODEX		0,26	2	4,45	Ø 410		VENUS alu				
							VENUS black				
							VENUS chrome				
REMODEX		0,26	2	4,60	Ø 400		VENUS wood alu				
							VENUS wood black				
							VENUS wood chrome				
REMODEX	4	0,32	4	4,90	395	425		VERBENA alu			
								VERBENA chrome			
REMODEX	4	0,32	4	4,90	395	425		VERBENA seat plus alu			
								VERBENA seat plus chrome			
REMODEX	4	0,34	4	5,80	395	425		VERBENA ARM alu			
								VERBENA ARM chrome			



Produkty posiadają Atest Badań Wytrzymałościowych.

Nowy Styl zastrzega sobie prawo do zmian: konstrukcyjnych, wymiarów, terminów dostaw; usunięcia produktów i zmian w palecie wykończeń.









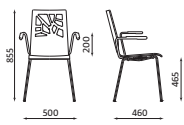

SZCZEGÓŁOWE WYKOŃCZENIA	TERMIN REALIZACJI	CENA MODELU W ZALEŻNOŚCI OD WYKOŃCZENIA [zł]						OFERTA
		TKANINA PODSTAWOWA (C/CU)	MICRO (M) SKAJ (V)	OBAN (EF) LUCIA (YB)	MICROFIRBA (CM) NOBLE LUX (NL) SOTI (SI)	ELEGANCE (EC) TECHNO (TCH) OXYGEN (OX)	CONTRACT (YN) NEXUS (UNY)	
	21	103 netto 126,69 brutto	103 netto 126,69 brutto					S
	ZP	101 netto 124,23 brutto	101 netto 124,23 brutto					S
	7	tylko w V-18N, V-46, V-17, V-49, V-51, V-82, V-98 108 netto 132,84 brutto						EX
	14	108 netto 132,84 brutto	108 netto 132,84 brutto					S
1.007, 1.008, 1.010, 1.031	21	138 netto 169,74 brutto						S
1.007, 1.008, 1.010, 1.031	ZP	136 netto 167,28 brutto						S
1.007, 1.008, 1.010, 1.031	14	141 netto 173,43 brutto						S
DREWNO	21	235 netto 289,05 brutto						P
LAMINAT	21	294 netto 361,62 brutto						P
DREWNO	21	238 netto 292,74 brutto						P
LAMINAT	21	298 netto 366,54 brutto						P
DREWNO	21		248 netto 305,04 brutto	254 netto 312,42 brutto	257 netto 316,11 brutto	263 netto 323,49 brutto	259 netto 318,57 brutto	P
LAMINAT	21		308 netto 378,84 brutto	313 netto 384,99 brutto	317 netto 389,91 brutto	323 netto 397,29 brutto	319 netto 392,37 brutto	P
DREWNO	21		251 netto 308,73 brutto	257 netto 316,11 brutto	260 netto 319,80 brutto	266 netto 327,18 brutto	262 netto 322,26 brutto	P
LAMINAT	21		311 netto 382,53 brutto	317 netto 389,91 brutto	320 netto 393,60 brutto	326 netto 400,98 brutto	322 netto 396,06 brutto	P
DREWNO	21	301 netto 370,23 brutto						P
LAMINAT	21	361 netto 444,03 brutto						P
DREWNO	21	304 netto 373,92 brutto						P
LAMINAT	21	364 netto 447,72 brutto						P

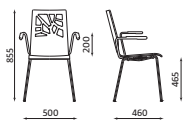
drewno: 1.007, 1.040, 1.010, 1.008, 1.016, 1.042, 1.023, 1.031, 1.033, 1.043
laminat: H1733, H3389, H3005, H3005 horizontal, H3704, W1000, U303, U630, U773, U321, U999
tworzywo sztuczne: szczegółowe wykończenia we wzorniku katalogu Kawiarnia.

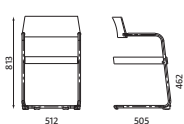
oferta: P – premium, S – standard, EX – express

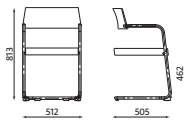
TERMIN REALIZACJI w dniach kalendarzowych.
ZP – ZA POTWIERDZENIEM – oznacza każdorazowe uzgadnianie terminu realizacji z Działem Handlowym.

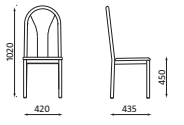

ważne informacje	składowanie w stosie max ilość [szt.]	objętość kartonu [m ³]	ilość w kartonie [szt.]	waga netto [kg]	siedzisko – szerokość [mm]	siedzisko – głębokość [mm]	MODEL		wymary w mm	
										
REMODEX	4	0,34	4	5,80	395	425			VERBENA ARM seat plus alu	VERBENA ARM seat plus chrome
	3	0,32	2	8,80	475	460			WAIT PP alu	WAIT PP chrome
	3	0,32	2	8,80	475	460			WAIT PC alu	WAIT PC chrome
REMODEX		0,32	2	8,60	470	410			ZEUS alu	ZEUS black



Produkty posiadają Atest Badań Wytrzymałościowych.

Nowy Styl zastrzega sobie prawo do zmian: konstrukcyjnych, wymiarów, terminów dostaw; usunięcia produktów i zmian w palecie wykończeń.















SZCZEGÓŁOWE WYKOŃCZENIA	TERMIN REALIZACJI	CENA MODELU W ZALEŻNOŚCI OD WYKOŃCZENIA [zł]						OFERTA
		TKANINA PODSTAWOWA (C/CU)	MICRO (M) SKAJ (V)	OBAN (EF) LUCIA (YB)	MICROFIRBA (CM) NOBLE LUX (NL) SOTI (SI)	ELEGANCE (EC) TECHNO (TCH) OXYGEN (OX)	CONTRACT (YN) NEXUS (UNY)	
DREWNO	21		314 netto 386,22 brutto	320 netto 393,60 brutto	323 netto 397,29 brutto	329 netto 404,67 brutto	325 netto 399,75 brutto	P
LAMINAT	21		374 netto 460,02 brutto	380 netto 467,40 brutto	383 netto 471,09 brutto	389 netto 478,47 brutto	385 netto 473,55 brutto	P
DREWNO	21		318 netto 391,14 brutto	323 netto 397,29 brutto	326 netto 400,98 brutto	332 netto 408,36 brutto	328 netto 403,44 brutto	P
LAMINAT	21		377 netto 463,71 brutto	383 netto 471,09 brutto	386 netto 474,78 brutto	392 netto 482,16 brutto	388 netto 477,24 brutto	P
	21		457 netto 562,11 brutto	468 netto 575,64 brutto	473 netto 581,79 brutto	499 netto 613,77 brutto	489 netto 601,47 brutto	P
	21		502 netto 617,46 brutto	513 netto 630,99 brutto	518 netto 637,14 brutto	544 netto 669,12 brutto	534 netto 656,82 brutto	P
	21		501 netto 616,23 brutto	512 netto 629,76 brutto	517 netto 635,91 brutto	543 netto 667,89 brutto	533 netto 655,59 brutto	P
	21		546 netto 671,58 brutto	557 netto 685,11 brutto	562 netto 691,26 brutto	588 netto 723,24 brutto	578 netto 710,94 brutto	P
	21	173 netto 212,79 brutto	173 netto 212,79 brutto					S
	ZP	168 netto 206,64 brutto	168 netto 206,64 brutto					S

drewno: 1.007, 1.040, 1.010, 1.008, 1.016, 1.042, 1.023, 1.031, 1.033, 1.043
laminat: H1733, H3389, H3005, H3005 horizontal, H3704, W1000, U303, U630, U773, U321, U999
tworzywo sztuczne: szczegółowe wykończenia we wzorniku katalogu Kawiarnia.

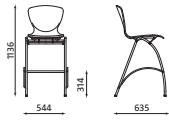
oferta: P – premium, S – standard, EX – express

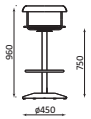
TERMIN REALIZACJI w dniach kalendarzowych.
ZP – ZA POTWIERDZENIEM – oznacza każdorazowe uzgadnianie terminu realizacji z Działem Handlowym.



ważne informacje	składowanie w stosie max. ilość [szt.]	objętość kartonu [m ³]	ilość w kartonie [szt.]	waga netto [kg]	siedzisko – szerokość [mm]	siedzisko – głębokość [mm]	MODEL		
							wymiary w mm		
REMODEX		0,31	1	6,45	378	356			BALENO HOCKER alu
									BALENO HOCKER chrome
REMODEX		0,25	1	5,90	378	356			BALENO 78 alu
									BALENO 78 chrome
REMODEX		0,31	1	6,45	378	350			BALENO HOCKER wood alu
									BALENO HOCKER wood chrome
REMODEX		0,25	1	5,90	378	350			BALENO 78 wood alu
									BALENO 78 wood chrome
REMODEX	4	0,5	2	9,00	445	455			BINGO HOCKER alu
									BINGO HOCKER chrome
REMODEX		0,25	1	18,30	Ø400				BISTRO HOCKER plus alu
									BISTRO HOCKER plus chrome
REMODEX		0,25	1	6,70	Ø430				BISTRO 78 plus alu
									BISTRO 78 plus chrome



SZCZEGÓŁOWE WYKOŃCZENIA	TERMIN REALIZACJI	CENA MODELU W ZALEŻNOŚCI OD WYKOŃCZENIA [zł]						OFERTA
		TKANINA PODSTAWOWA (C/CU)	MICRO (M) SKAJ (V)	OBAN (EF) LUCIA (YB)	MICROFIRBA (CM) NOBLE LUX (NL) SOTI (SI)	ELEGANCE (EC) TECHNO (TCH) OXYGEN (OX)	CONTRACT (YN) NEXUS (UNY)	
	21		206 netto 253,38 brutto	214 netto 263,22 brutto	216 netto 265,68 brutto	221 netto 271,83 brutto	218 netto 268,14 brutto	P
	21		251 netto 308,73 brutto	260 netto 319,80 brutto	263 netto 323,49 brutto	267 netto 328,41 brutto	265 netto 325,95 brutto	P
	21		199 netto 244,77 brutto	206 netto 253,38 brutto	208 netto 255,84 brutto	214 netto 263,22 brutto	210 netto 258,30 brutto	P
	21		237 netto 291,51 brutto	245 netto 301,35 brutto	247 netto 303,81 brutto	252 netto 309,96 brutto	249 netto 306,27 brutto	P
DREWNO	21		225 netto 276,75 brutto					P
DREWNO	14		276 netto 339,48 brutto					P
DREWNO	21		219 netto 269,37 brutto					P
DREWNO	14		260 netto 319,80 brutto					P
DREWNO	21		381 netto 468,63 brutto					P
LAMINAT	21		426 netto 523,98 brutto					P
DREWNO	14		385 netto 473,55 brutto					P
LAMINAT	21		430 netto 528,90 brutto					P
	21		551 netto 677,73 brutto	556 netto 683,88 brutto	559 netto 687,57 brutto	567 netto 697,41 brutto	562 netto 691,26 brutto	P
	21		557 netto 685,11 brutto	561 netto 690,03 brutto	564 netto 693,72 brutto	573 netto 704,79 brutto	567 netto 697,41 brutto	P
	21		283 netto 348,09 brutto	288 netto 354,24 brutto	291 netto 357,93 brutto	300 netto 369,00 brutto	294 netto 361,62 brutto	P
	21		289 netto 355,47 brutto	294 netto 361,62 brutto	298 netto 366,54 brutto	306 netto 376,38 brutto	301 netto 370,23 brutto	P

drewno: 1.007, 1.040, 1.010, 1.008, 1.016, 1.042, 1.023, 1.031, 1.033, 1.043

laminat: H1733, H3389, H3005, H3005 horizontal, H3704, W1000, U303, U630, U773, U321, U999











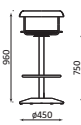

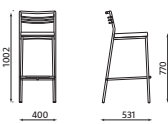

tworzywo sztuczne: szczegółowe wykończenia we wzorniku katalogu Kawiarnia.

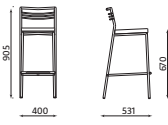
oferta: P – premium, S – standard, EX – express

TERMIN REALIZACJI w dniach kalendarzowych.

ZP – ZA POTWIERDZENIEM – oznacza każdorazowe uzgadnianie terminu realizacji z Działem Handlowym.



ważne informacje	składowanie w stosie max. ilość [szt.]	objętość kartonu [m ³]	ilość w kartonie [szt.]	waga netto [kg]	siedzisko – szerokość [mm]	siedzisko – głębokość [mm]	MODEL		
							wymiary w mm		
REMODEX		0,25	1	17,90	Ø400			BISTRO HOCKER alu	
								BISTRO HOCKER chrome	
REMODEX		0,25	1	6,30	Ø430			BISTRO 78 alu	
								BISTRO 78 chrome	
REMODEX		0,25	1	6,10	380	365			CALDO HOCKER alu
									CALDO HOCKER chrome
REMODEX		0,24	1	6,00	380	364			CALDO 78 alu
									CALDO 78 chrome
REMODEX		0,31	1	5,30	360	360			DOLCE HOCKER alu
									DOLCE HOCKER chrome
REMODEX		0,25	1	5,00	360	360			DOLCE 78 alu
									DOLCE 78 chrome
REMODEX		0,31	1	5,10	360	360			DOLCE HOCKER wood alu
									DOLCE HOCKER wood chrome



Produkty posiadają Atest Badań Wytrzymałościowych.

Nowy Styl zastrzega sobie prawo do zmian: konstrukcyjnych, wymiarów, terminów dostaw; usunięcia produktów i zmian w palecie wykończeń.





SZCZEGÓŁOWE WYKOŃCZENIA	TERMIN REALIZACJI	CENA MODELU W ZALEŻNOŚCI OD WYKOŃCZENIA [zł]						OFERTA
		TKANINA PODSTAWOWA (C/CU)	MICRO (M) SKAJ (V)	OBAN (EF) LUCIA (YB)	MICROFIRBA (CM) NOBLE LUX (NL) SOTI (SI)	ELEGANCE (EC) TECHNO (TCH) OXYGEN (OX)	CONTRACT (YN) NEXUS (UNY)	
DREWNO	21	518 netto 637,14 brutto						P
DREWNO	14	534 netto 656,82 brutto						P
DREWNO	21	249 netto 306,27 brutto						P
DREWNO	14	257 netto 316,11 brutto						P
	21		258 netto 317,34 brutto	268 netto 329,64 brutto	272 netto 334,56 brutto	279 netto 343,17 brutto	277 netto 340,71 brutto	P
	21		314 netto 386,22 brutto	326 netto 400,98 brutto	330 netto 405,90 brutto	336 netto 413,28 brutto	334 netto 410,82 brutto	P
	21		248 netto 305,04 brutto	261 netto 321,03 brutto	265 netto 325,95 brutto	271 netto 333,33 brutto	269 netto 330,87 brutto	P
	21		302 netto 371,46 brutto	315 netto 387,45 brutto	320 netto 393,60 brutto	326 netto 400,98 brutto	324 netto 398,52 brutto	P
	21		228 netto 280,44 brutto	236 netto 290,28 brutto	238 netto 292,74 brutto	242 netto 297,66 brutto	240 netto 295,20 brutto	P
	21		257 netto 316,11 brutto	263 netto 323,49 brutto	265 netto 325,95 brutto	269 netto 330,87 brutto	267 netto 328,41 brutto	P
	21		219 netto 269,37 brutto	226 netto 277,98 brutto	228 netto 280,44 brutto	233 netto 286,59 brutto	230 netto 282,90 brutto	P
	21		239 netto 293,97 brutto	245 netto 301,35 brutto	247 netto 303,81 brutto	251 netto 308,73 brutto	249 netto 306,27 brutto	P
DREWNO	21	260 netto 319,80 brutto						P
DREWNO	14	289 netto 355,47 brutto						P

drewno: 1.007, 1.040, 1.010, 1.008, 1.016, 1.042, 1.023, 1.031, 1.033, 1.043
laminat: H1733, H3389, H3005, H3005 horizontal, H3704, W1000, U303, U630, U773, U321, U999
tworzywo sztuczne: szczegółowe wykończenia we wzorniku katalogu Kawiarnia.

oferta: P – premium, S – standard, EX – express

TERMIN REALIZACJI w dniach kalendarzowych.
ZP – ZA POTWIERDZENIEM – oznacza każdorazowe uzgadnianie terminu realizacji z Działem Handlowym.



ważne informacje	składowanie w stosie max. ilość (szt.)	objętość kartonu [m ³]	ilość w kartonie [szt.]	waga netto [kg]	siedzisko – szerokość [mm]	siedzisko – głębokość [mm]	MODEL			2 lata na produkt GWARANCJA
							wymiary w mm			
REMODEX		0,25	1	4,80	360	360		DOLCE 78 wood alu		
								DOLCE 78 wood chrome		
REMODEX		0,31	1	5,70	380	380		FIAMMA HOCKER alu		
								FIAMMA HOCKER chrome		
REMODEX		0,25	1	5,30	380	380		FIAMMA 78 alu		
								FIAMMA 78 chrome		
REMODEX		0,31	1	5,70	370	370		FIAMMA HOCKER wood alu		
								FIAMMA HOCKER wood chrome		
REMODEX		0,25	1	5,30	370	370		FIAMMA 78 wood alu		
								FIAMMA 78 wood chrome		









SZCZEGÓŁOWE WYKOŃCZENIA	TERMIN REALIZACJI	CENA MODELU W ZALEŻNOŚCI OD WYKOŃCZENIA [zł]						OFERTA
		TKANINA PODSTAWOWA (C/CU)	MICRO (M) SKAJ (V)	OBAN (EF) LUCIA (YB)	MICROFIRBA (CM) NOBLE LUX (NL) SOTI (SI)	ELEGANCE (EC) TECHNO (TCH) OXYGEN (OX)	CONTRACT (YN) NEXUS (UNY)	
DREWNO	21	250 netto 307,50 brutto						P
DREWNO	21	271 netto 333,33 brutto						P
	21		260 netto 319,80 brutto	263 netto 323,49 brutto	266 netto 327,18 brutto	275 netto 338,25 brutto	270 netto 332,10 brutto	P
	21		280 netto 344,40 brutto	283 netto 348,09 brutto	286 netto 351,78 brutto	295 netto 362,85 brutto	290 netto 356,70 brutto	P
	21		247 netto 303,81 brutto	250 netto 307,50 brutto	253 netto 311,19 brutto	262 netto 322,26 brutto	257 netto 316,11 brutto	P
	21		267 netto 328,41 brutto	270 netto 332,10 brutto	273 netto 335,79 brutto	282 netto 346,86 brutto	277 netto 340,71 brutto	P
DREWNO	21	276 netto 339,48 brutto						P
DREWNO	21	296 netto 364,08 brutto						P
DREWNO	21	263 netto 323,49 brutto						P
DREWNO	21	283 netto 348,09 brutto						P

drewno: 1.007, 1.040, 1.010, 1.008, 1.016, 1.042, 1.023, 1.031, 1.033, 1.043
laminat: H1733, H3389, H3005, H3005 horizontal, H3704, W1000, U303, U630, U773, U321, U999
tworzywo sztuczne: szczegółowe wykończenia we wzorniku katalogu Kawiarnia.

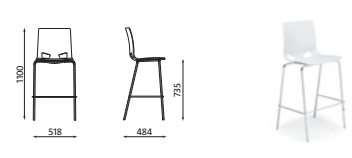
oferta: P – premium, S – standard, EX – express

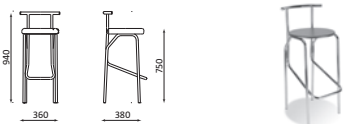
TERMIN REALIZACJI w dniach kalendarzowych.
ZP – ZA POTWIERDZENIEM – oznacza każdorazowe uzgadnianie terminu realizacji z Działem Handlowym.

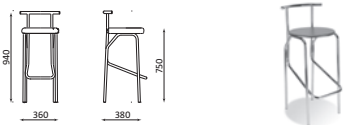

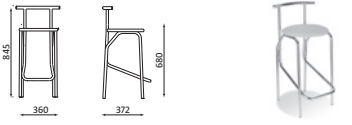
ważne informacje	składowanie w stosie max. ilość [szt.]	objętość kartonu [m ³]	ilość w kartonie [szt.]	waga netto [kg]	siedzisko – szerokość [mm]	siedzisko – głębokość [mm]	MODEL wymiary w mm	2 lata na produkt GWARANCJA
	6	0,49	4	5,70	445	410		FONDO HOCKER alu
								FONDO HOCKER chrome
								FONDO HOCKER ral 9005
								FONDO HOCKER ral 2003
								FONDO HOCKER ral 7016
								FONDO HOCKER ral 9003
		0,19	1	7,20	Ø375		JOLA alu	
							JOLA chrome	
		0,19	1	8,00	Ø380		JOLA wood alu	
							JOLA wood chrome	
		0,18	1	5,95	Ø375		JOLA 78 alu	
							JOLA 78 chrome	













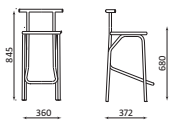

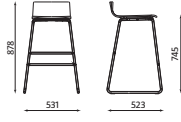

SZCZEGÓLWE WYKOŃCZENIA	TERMIN REALIZACJI	CENA MODELU W ZALEŻNOŚCI OD WYKOŃCZENIA [zł]						OFERTA
		TKANINA PODSTAWOWA (C/CU)	MICRO (M) SKAJ (V)	OBAN (EF) LUCIA (YB)	MICROFIRBA (CM) NOBLE LUX (NL) SOTI (SI)	ELEGANCE (EC) TECHNO (TCH) OXYGEN (OX)	CONTRACT (YN) NEXUS (UNY)	
TWORZYWO SZTUCZNE	ZP	245 netto 301,35 brutto						P
TWORZYWO SZTUCZNE	ZP	280 netto 344,40 brutto						P
GLOSS ORANGE	ZP	280 netto 344,40 brutto						P
GLOSS WHITE	ZP	280 netto 344,40 brutto						P
GLOSS ORANGE	ZP	280 netto 344,40 brutto						P
GLOSS ANTHRACITE	ZP	280 netto 344,40 brutto						P
GLOSS WHITE	ZP	280 netto 344,40 brutto						P
	21		126 netto 154,98 brutto	134 netto 164,82 brutto	137 netto 168,51 brutto	140 netto 172,20 brutto	P	
	7	tylko w V-18N, V-46, V-17, V-49, V-51, V-82, V-98 146 netto 179,58 brutto						EX
	14		146 netto 179,58 brutto	153 netto 188,19 brutto	156 netto 191,88 brutto	159 netto 195,57 brutto	P	
DREWNO	21	158 netto 194,34 brutto						P
DREWNO	14	178 netto 218,94 brutto						P
	21		117 netto 143,91 brutto	124 netto 152,52 brutto	128 netto 157,44 brutto	131 netto 161,13 brutto	P	
	14		137 netto 168,51 brutto	143 netto 175,89 brutto	146 netto 179,58 brutto	150 netto 184,50 brutto	P	

drewno: 1.007, 1.040, 1.010, 1.008, 1.016, 1.042, 1.023, 1.031, 1.033, 1.043
laminat: H1733, H3389, H3005, H3005 horizontal, H3704, W1000, U303, U630, U773, U321, U999
tworzywo sztuczne: szczegółowe wykończenia we wzorniku katalogu Kawiarnia.

oferta: P – premium, S – standard, EX – express

TERMIN REALIZACJI w dniach kalendarzowych.
ZP – ZA POTWIERDZENIEM – oznacza każdorazowe uzgadnianie terminu realizacji z Działem Handlowym.

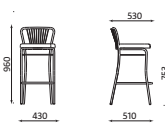

ważne informacje	składowanie w stosie max. ilość [szt.]	objętość kartonu [m ³]	ilość w kartonie [szt.]	waga netto [kg]	siedzisko – szerokość [mm]	siedzisko – głębokość [mm]	MODEL		
							wymiary w mm		
REMODEX		0,18	1	5,95	Ø380			JOLA 78 wood alu	
								JOLA 78 wood chrome	
REMODEX		0,07	1	5,10	370	390			LATTE HOCKER alu
									LATTE HOCKER chrome
REMODEX		0,24	1	5,65	400	415			MOLINO HOCKER plus alu
									MOLINO HOCKER plus chrome
REMODEX		0,24	1	5,35	400	415			MOLINO 78 plus alu
									MOLINO 78 plus chrome
REMODEX		0,23	1	5,55	395	415			MOLINO HOCKER wood alu
									MOLINO HOCKER wood chrome
REMODEX		0,24	1	5,20	395	415			MOLINO 78 wood alu
									MOLINO 78 wood chrome
REMODEX		0,24	1	6,42	430	430			NERON HOCKER alu
									NERON HOCKER chrome













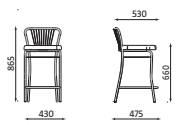

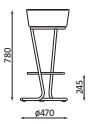

SZCZEGÓŁOWE WYKOŃCZENIA	TERMIN REALIZACJI	CENA MODELU W ZALEŻNOŚCI OD WYKOŃCZENIA [zł]						OFERTA
		TKANINA PODSTAWOWA (C/CU)	MICRO (M) SKAJ (V)	OBAN (EF) LUCIA (YB)	MICROFIRBA (CM) NOBLE LUX (NL) SOTI (SI)	ELEGANCE (EC) TECHNO (TCH) OXYGEN (OX)	CONTRACT (YN) NEXUS (UNY)	
	21	149 netto 183,27 brutto						P
	14	168 netto 206,64 brutto						P
DREWNO	21	286 netto 351,78 brutto						P
LAMINAT	21	329 netto 404,67 brutto						P
DREWNO	21	310 netto 381,30 brutto						P
LAMINAT	21	353 netto 434,19 brutto						P
	21		238 netto 292,74 brutto	245 netto 301,35 brutto	248 netto 305,04 brutto	256 netto 314,88 brutto	252 netto 309,96 brutto	P
	14		267 netto 328,41 brutto	275 netto 338,25 brutto	278 netto 341,94 brutto	285 netto 350,55 brutto	282 netto 346,86 brutto	P
	21		218 netto 268,14 brutto	224 netto 275,52 brutto	227 netto 279,21 brutto	235 netto 289,05 brutto	231 netto 284,13 brutto	P
	14		246 netto 302,58 brutto	254 netto 312,42 brutto	257 netto 316,11 brutto	264 netto 324,72 brutto	261 netto 321,03 brutto	P
DREWNO	21	248 netto 305,04 brutto						P
DREWNO	14	277 netto 340,71 brutto						P
DREWNO	21	226 netto 277,98 brutto						P
DREWNO	14	257 netto 316,11 brutto						P
	21	182 netto 223,86 brutto	182 netto 223,86 brutto					S
	21	198 netto 243,54 brutto	198 netto 243,54 brutto					S

drewno: 1.007, 1.040, 1.010, 1.008, 1.016, 1.042, 1.023, 1.031, 1.033, 1.043
laminat: H1733, H3389, H3005, H3005 horizontal, H3704, W1000, U303, U630, U773, U321, U999
tworzywo sztuczne: szczegółowe wykończenia we wzorniku katalogu Kawiarnia.

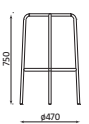
oferta: P – premium, S – standard, EX – express

TERMIN REALIZACJI w dniach kalendarzowych.
ZP – ZA POTWIERDZENIEM – oznacza każdorazowe uzgadnianie terminu realizacji z Działem Handlowym.

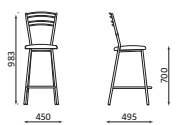

ważne informacje	składowanie w stosie max. ilość [szt.]	objętość kartonu [m ³]	ilość w kartonie [szt.]	waga netto [kg]	siedzisko – szerokość [mm]	siedzisko – głębokość [mm]	MODEL			2 lata na produkt GWARANCJA
							wymiary w mm			
REMODEX		0,21	1	5,90	430	430			NERON 78 alu	NERON 78 chrome
REMODEX		0,21	1	7,60	∅355			PINACOLADA HOCKER chrome		
REMODEX		0,15	1	6,75	∅360			RETRO chrome		
REMODEX		0,15	1	6,95	∅360			RETRO TWIST chrome		
REMODEX		0,14	1	4,62	∅310			RINGO HOCKER alu	RINGO HOCKER chrome	
REMODEX		0,31	1	6,30	∅375			ROSSO HOCKER alu	ROSSO HOCKER chrome	
REMODEX		0,31	1	6,00	∅375			ROSSO 78 alu	ROSSO 78 chrome	













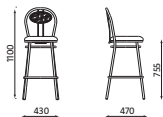

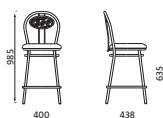
SZCZEGÓŁOWE WYKOŃCZENIA	TERMIN REALIZACJI	CENA MODELU W ZALEŻNOŚCI OD WYKOŃCZENIA [zł]						OFERTA
		TKANINA PODSTAWOWA (C/CU)	MICRO (M) SKAJ (V)	OBAN (EF) LUCIA (YB)	MICROFIRBA (CM) NOBLE LUX (NL) SOTI (SI)	ELEGANCE (EC) TECHNO (TCH) OXYGEN (OX)	CONTRACT (YN) NEXUS (UNY)	
	21	168 netto 206,64 brutto	168 netto 206,64 brutto					S
	21	185 netto 227,55 brutto	185 netto 227,55 brutto					S
	14		277 netto 340,71 brutto			tylko w TCH 300 netto 369,00 brutto	296 netto 364,08 brutto	P
	21		tylko w V 168 netto 206,64 brutto					S
	21		tylko w V 196 netto 241,08 brutto					S
DREWNO	14	165 netto 202,95 brutto						P
DREWNO	14	189 netto 232,47 brutto						P
	21	225 netto 276,75 brutto	225 netto 276,75 brutto					S
	14	248 netto 305,04 brutto	248 netto 305,04 brutto					S
	21	206 netto 253,38 brutto	206 netto 253,38 brutto					S
	14	229 netto 281,67 brutto	229 netto 281,67 brutto					S

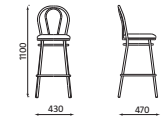
drewno: 1.007, 1.040, 1.010, 1.008, 1.016, 1.042, 1.023, 1.031, 1.033, 1.043
laminat: H1733, H3389, H3005, H3005 horizontal, H3704, W1000, U303, U630, U773, U321, U999
tworzywo sztuczne: szczegółowe wykończenia we wzorniku katalogu Kawiarnia.

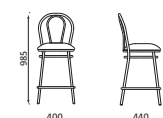
oferta: P – premium, S – standard, EX – express

TERMIN REALIZACJI w dniach kalendarzowych.
ZP – ZA POTWIERDZENIEM – oznacza każdorazowe uzgadnianie terminu realizacji z Działem Handlowym.

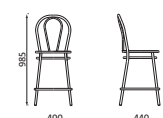

ważne informacje	składowanie w stosie max. ilość [szt.]	objętość kartonu [m ³]	ilość w kartonie [szt.]	waga netto [kg]	siedzisko – szerokość [mm]	siedzisko – głębokość [mm]	MODEL		
							wymiary w mm		
REMODEX		0,23	1	6,30	Ø 410			TIZIANO HOCKER alu	
								TIZIANO HOCKER chrome	
REMODEX		0,31	2	6,30	Ø 410			TIZIANO 78 alu	
								TIZIANO 78 chrome	
REMODEX		0,23	1	6,30	Ø 410			TULIPAN HOCKER alu	
								TULIPAN HOCKER black	
								TULIPAN HOCKER chrome	
REMODEX		0,3	2	6,10	Ø 410			TULIPAN 78 alu	
								TULIPAN 78 black	
								TULIPAN 78 chrome	
REMODEX		0,23	1	6,50	Ø 400			TULIPAN HOCKER wood alu	
								TULIPAN HOCKER wood black	
								TULIPAN HOCKER wood chrome	
REMODEX		0,3	2	6,30	Ø 400			TULIPAN 78 wood alu	
								TULIPAN 78 wood black	
								TULIPAN 78 wood chrome	



Produkty posiadają Atest Badań Wytrzymałościowych.

Nowy Styl zastrzega sobie prawo do zmian: konstrukcyjnych, wymiarów, terminów dostaw; usunięcia produktów i zmian w palecie wykończeń.









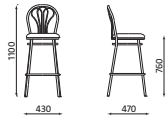

SZCZEGÓŁOWE WYKOŃCZENIA	TERMIN REALIZACJI	CENA MODELU W ZALEŻNOŚCI OD WYKOŃCZENIA [zł]						OFERTA
		TKANINA PODSTAWOWA (C/CU)	MICRO (M) SKAJ (V)	OBAN (EF) LUCIA (YB)	MICROFIRBA (CM) NOBLE LUX (NL) SOTI (SI)	ELEGANCE (EC) TECHNO (TCH) OXYGEN (OX)	CONTRACT (YN) NEXUS (UNY)	
	21		179 netto 220,17 brutto		182 netto 223,86 brutto			P
	7	tylko w V-18N, V-46, V-17, V-49, V-51, V-82, V-98 198 netto 243,54 brutto						EX
	14		198 netto 243,54 brutto		201 netto 247,23 brutto			P
	21		172 netto 211,56 brutto		175 netto 215,25 brutto			P
	7	tylko w V-18N, V-46, V-17, V-49, V-51, V-82, V-98 188 netto 231,24 brutto						EX
	14		188 netto 231,24 brutto		192 netto 236,16 brutto			P
	21	139 netto 170,97 brutto	139 netto 170,97 brutto					S
	ZP	132 netto 162,36 brutto	132 netto 162,36 brutto					S
	14	159 netto 195,57 brutto	159 netto 195,57 brutto					S
	21	129 netto 158,67 brutto	129 netto 158,67 brutto					S
	ZP	122 netto 150,06 brutto	122 netto 150,06 brutto					S
	14	149 netto 183,27 brutto	149 netto 183,27 brutto					S
1.007, 1.008, 1.010, 1.031	21	170 netto 209,10 brutto						S
1.007, 1.008, 1.010, 1.031	ZP	163 netto 200,49 brutto						S
1.007, 1.008, 1.010, 1.031	14	190 netto 233,70 brutto						S
1.007, 1.008, 1.010, 1.031	21	160 netto 196,80 brutto						S
1.007, 1.008, 1.010, 1.031	ZP	153 netto 188,19 brutto						S
1.007, 1.008, 1.010, 1.031	14	180 netto 221,40 brutto						S

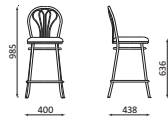
drewno: 1.007, 1.040, 1.010, 1.008, 1.016, 1.042, 1.023, 1.031, 1.033, 1.043
laminat: H1733, H3389, H3005, H3005 horizontal, H3704, W1000, U303, U630, U773, U321, U999
tworzywo sztuczne: szczegółowe wykończenia we wzorniku katalogu Kawiarnia.

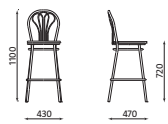
oferta: P – premium, S – standard, EX – express

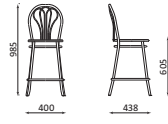
TERMIN REALIZACJI w dniach kalendarzowych.
ZP – ZA POTWIERDZENIEM – oznacza każdorazowe uzgadnianie terminu realizacji z Działem Handlowym.

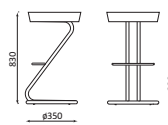

ważne informacje	składowanie w stosie max. ilość [szt.]	objętość kartonu [m ³]	ilość w kartonie [szt.]	waga netto [kg]	siedzisko – szerokość [mm]	siedzisko – głębokość [mm]	MODEL wymiary w mm	
REMODEX		0,23	1	6,30	Ø 410			VENUS HOCKER alu
								VENUS HOCKER black
								VENUS HOCKER chrome
REMODEX		0,30	2	6,10	Ø 410			VENUS 78 alu
								VENUS 78 black
								VENUS 78 chrome
REMODEX		0,23	1	6,50	Ø 400			VENUS HOCKER wood alu
								VENUS HOCKER wood black
								VENUS HOCKER wood chrome
REMODEX		0,30	2	6,30	Ø 400			VENUS 78 wood alu
								VENUS 78 wood black
								VENUS 78 wood chrome
REMODEX		0,15	2	6,40	Ø 340			ZETA chrome



SZCZEGÓŁOWE WYKOŃCZENIA	TERMIN REALIZACJI	CENA MODELU W ZALEŻNOŚCI OD WYKOŃCZENIA [zł]						OFERTA
		TKANINA PODSTAWOWA (C/CU)	MICRO (M) SKAJ (V)	OBAN (EF) LUCIA (YB)	MICROFIRBA (CM) NOBLE LUX (NL) SOTI (SI)	ELEGANCE (EC) TECHNO (TCH) OXYGEN (OX)	CONTRACT (YN) NEXUS (UNY)	
	21	142 netto 174,66 brutto	142 netto 174,66 brutto					S
	ZP	135 netto 166,05 brutto	135 netto 166,05 brutto					S
	7	tylko w V-18N, V-46, V-17, V-49, V-51, V-82, V-98 163 netto 200,49 brutto						EX
	14	163 netto 200,49 brutto	163 netto 200,49 brutto					S
	21	133 netto 163,59 brutto	133 netto 163,59 brutto					S
	ZP	126 netto 154,98 brutto	126 netto 154,98 brutto					S
	7	tylko w V-18N, V-46, V-17, V-49, V-51, V-82, V-98 153 netto 188,19 brutto						EX
	14	153 netto 188,19 brutto	153 netto 188,19 brutto					S
1.007, 1.008, 1.010, 1.031	21	177 netto 217,71 brutto						S
1.007, 1.008, 1.010, 1.031	ZP	170 netto 209,10 brutto						S
1.007, 1.008, 1.010, 1.031	14	198 netto 243,54 brutto						S
1.007, 1.008, 1.010, 1.031	21	168 netto 206,64 brutto						S
1.007, 1.008, 1.010, 1.031	ZP	161 netto 198,03 brutto						S
1.007, 1.008, 1.010, 1.031	14	188 netto 231,24 brutto						S
	7	tylko w V-18N, V-46, V-17, V-49, V-51, V-82, V-98 156 netto 191,88 brutto						EX
	14		tylko w V 156 netto 191,88 brutto					S

drewno: 1.007, 1.040, 1.010, 1.008, 1.016, 1.042, 1.023, 1.031, 1.033, 1.043
laminat: H1733, H3389, H3005, H3005 horizontal, H3704, W1000, U303, U630, U773, U321, U999
tworzywo sztuczne: szczegółowe wykończenia we wzorniku katalogu Kawiarnia.

oferta: P – premium, S – standard, EX – express

TERMIN REALIZACJI w dniach kalendarzowych.
ZP – ZA POTWIERDZENIEM – oznacza każdorazowe uzgadnianie terminu realizacji z Działem Handlowym.



ważne informacje	składowanie w stosie (max. ilość szt.)	objętość kartonu [m ³]	ilość w kartonie [szt.]	waga netto [kg]	siedzisko – szerokość [mm]	MODEL wymiary w mm		
REMODEX	6	0,10	4	2,90	Ø 340			CHICO alu
								CHICO black
								CHICO chrome
REMODEX	6	0,12	4	3,00	Ø 350			GRAPPO alu
								GRAPPO chrome
REMODEX	6	0,12	4	2,90	Ø 340			GRAPPO wood alu
								GRAPPO wood chrome
REMODEX		0,09	2	3,30	Ø 365			HARPO alu
								HARPO chrome
REMODEX		0,09	2	3,30	Ø 360			HARPO wood alu
								HARPO wood chrome
REMODEX		0,19	2	4,90	Ø 355			PINACOLADA stool chrome



Produkty posiadają Atest Badań Wytrzymałościowych.

Nowy Styl zastrzega sobie prawo do zmian: konstrukcyjnych, wymiarów, terminów dostaw; usunięcia produktów i zmian w palecie wykończeń.

SZCZEGÓŁOWE WYKOŃCZENIA	TERMIN REALIZACJI	CENA MODELU W ZALEŻNOŚCI OD WYKOŃCZENIA [zł]				OFERTA
		TKANINA PODSTAWOWA (C/CU)	MICRO (M) SKAJ (V)	TECHNO (TCH)	CONTRACT (YN) NEXUS (UNY)	
	21	54 netto 66,42 brutto	54 netto 66,42 brutto			S
	ZP	52 netto 63,96 brutto	52 netto 63,96 brutto			S
	14	61 netto 75,03 brutto	61 netto 75,03 brutto			S
	21	78 netto 95,94 brutto	78 netto 95,94 brutto			S
	14	82 netto 100,86 brutto	82 netto 100,86 brutto			S
1.007, 1.008, 1.010, 1.031	21	103 netto 126,69 brutto				S
1.007, 1.008, 1.010, 1.031	14	108 netto 132,84 brutto				S
	21	84 netto 103,32 brutto	84 netto 103,32 brutto			S
	14	91 netto 111,93 brutto	91 netto 111,93 brutto			S
1.007, 1.008, 1.010, 1.031	21	111 netto 136,53 brutto				S
1.007, 1.008, 1.010, 1.031	14	119 netto 146,37 brutto				S
	14		206 netto 253,38 brutto	236 netto 290,28 brutto	233 netto 286,59 brutto	P

drewno: 1.007, 1.040, 1.010, 1.008, 1.016, 1.042, 1.023, 1.031, 1.033, 1.043
laminat: H1733, H3389, H3005, H3005 horizontal, H3704, W1000, U303, U630, U773, U321, U999
tworzywo sztuczne: szczegółowe wykończenia we wzorniku katalogu Kawiarnia.

oferta: P – premium, S – standard, EX – express

TERMIN REALIZACJI w dniach kalendarzowych.
ZP – ZA POTWIERDZENIEM – oznacza każdorazowe uzgadnianie terminu realizacji z Działem Handlowym.



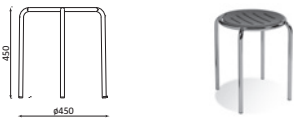
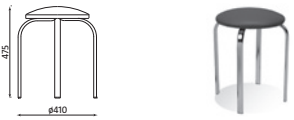



ważne informacje	składowanie w stosie (max. ilość szt.)	objętość kartonu [m ³]	ilość w kartonie [szt.]	waga netto [kg]	siedzisko – szerokość [mm]	MODEL wymiary w mm <div data-bbox="1412 206 1508 264" style="float: right; border: 1px solid black; padding: 2px;"> 2 lata na produkt GWARANCJA </div>	
REMODEX	8	0,11	4	3,02	Ø 310		RINGO alu
						RINGO chrome	
REMODEX	6	0,10	4	2,90	Ø 340		ZEPPO alu
						ZEPPO black	
						ZEPPO chrome	

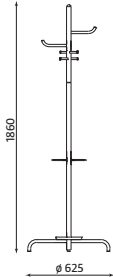

SZCZEGÓŁOWE WYKOŃCZENIA	TERMIN REALIZACJI	CENA MODELU W ZALEŻNOŚCI OD WYKOŃCZENIA [zł]				OFERTA
		TKANINA PODSTAWOWA (C/CU)	MICRO (M) SKAJ (V)	TECHNO (TCH)	CONTRACT (YN) NEXUS (UNY)	
DREWNO	21	136 netto 167,28 brutto				P
1.007, 1.010, 1.033	7	146 netto 179,58 brutto				EX
POZOSTAŁE KOLORY DREWNA	14	146 netto 179,58 brutto				P
	21	56 netto 68,88 brutto	56 netto 68,88 brutto			S
	ZP	54 netto 66,42 brutto	54 netto 66,42 brutto			S
	14	61 netto 75,03 brutto	61 netto 75,03 brutto			S

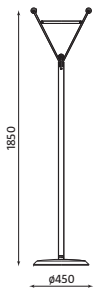









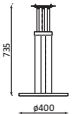

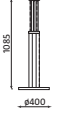

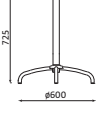

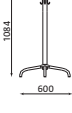

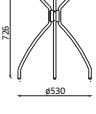
WIESZAKI

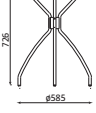
objętość kartonu [m³]	ilość w kartonie [szt.]	waga netto [kg]	MODEL wymiary w mm		TERMIN REALIZACJI	CENA [zł]	OFERTA	
0,03	1	4,90	 		ARIZONA alu	7	154 netto 189,42 brutto	EX
					ARIZONA kwarc	7	154 netto 189,42 brutto	EX
					ARIZONA black	5	145 netto 178,35 brutto	EX
					ARIZONA chrome	7	172 netto 211,56 brutto	EX
0,08	1	11,20	 		21	289 netto 355,47 brutto	P	

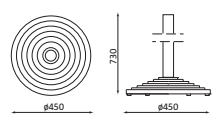

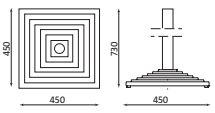











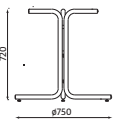









drewno: 1.007, 1.040, 1.010, 1.008, 1.016, 1.042, 1.023, 1.031, 1.033, 1.043
 laminat: H1733, H3389, H3005, H3005 horizontal, H3704, W1000, U303, U630, U773, U321, U999
 tworzywo sztuczne: szczególwe wykończenia we wzorniku katalogu Kawiarnia.

oferta: P – premium, S – standard, EX – express

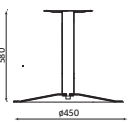

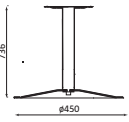









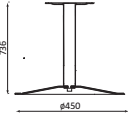

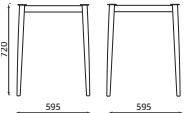

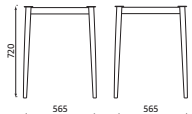

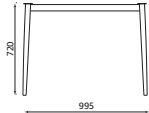

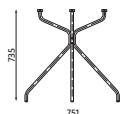

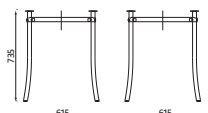
TERMIN REALIZACJI w dniach kalendarzowych.
 ZP – ZA POTWIERDZENIEM – oznacza każdorazowe uzgadnianie terminu realizacji z Działem Handlowym.

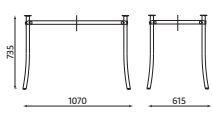
ważne informacje	objętość kartonu [m ³]	ilość w kartonie [szt.]	waga netto [kg]	MODEL wymiary w mm			TERMIN REALIZACJI	CENA [zł]	OFERTA
REMODEX	0,14	1	22,00			BISTRO TABLE alu	21	420 netto 516,60 brutto	P
						BISTRO TABLE chrome	14	426 netto 523,98 brutto	P
REMODEX	0,21	1	24,00			BISTRO TABLE 1100 alu	21	451 netto 554,73 brutto	P
						BISTRO TABLE 1100 chrome	14	464 netto 570,72 brutto	P
REMODEX	0,08	1	7,30			CAFE TABLE alu	21	89 netto 109,47 brutto	P
						CAFE TABLE chrome	14	96 netto 118,08 brutto	P
REMODEX	0,1	1	8,50			CAFE 1100 TABLE alu	21	129 netto 158,67 brutto	P
						CAFE 1100 TABLE chrome	14	135 netto 166,05 brutto	P
REMODEX	0,03	1	2,53			DONA-3 alu	21	69 netto 84,87 brutto	S
						DONA-3 chrome	14	76 netto 93,48 brutto	S
REMODEX	0,03	1	3,36			DONA-4 alu	21	88 netto 108,24 brutto	S
						DONA-4 chrome	14	95 netto 116,85 brutto	S
REMODEX	0,03	1	14,40			FLORIDA 01S 45 A/70A	14	307 netto 377,61 brutto	S
						FLORIDA 01S 45 B/70B	ZP	300 netto 369,00 brutto	S
						FLORIDA 01S 45 B/70C	ZP	312 netto 383,76 brutto	S
REMODEX	0,04	1	14,00			FLORIDA 02S 45 A/70A	14	362 netto 445,26 brutto	S
						FLORIDA 02S 45 B/70B	ZP	354 netto 435,42 brutto	S
						FLORIDA 02S 45 B/70C	ZP	367 netto 451,41 brutto	S
	0,015	komplet (4 nogi)	4,40			KAJA 500 TABLE chrome	14	102 netto 125,46 brutto	S

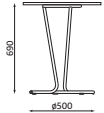

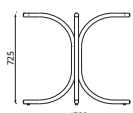
ważne informacje	objętość kartonu [m ³]	ilość w kartonie [szt.]	waga netto [kg]	MODEL wymiary w mm	 2 lata na produkt GWARANCJA	TERMIN REALIZACJI	CENA [zł]	OFERTA	
REMODEX	0,02	komplet (4 nogi)	6,40			KAJA chrome Ø 50 mm	7	130 netto 159,90 brutto	S, EX
REMODEX	0,02	komplet (4 nogi)	6,40			KAJA chrome Ø 60 mm regulowana	7	159 netto 195,57 brutto	EX
REMODEX	0,05	1	5,20			KARINA black	ZP	107 netto 131,61 brutto	S
						KARINA chrome	7	129 netto 158,67 brutto	S, EX
 REMODEX	0,076	1	16,30			LARA INOX	14	368 netto 452,64 brutto	P
 REMODEX	0,045	1	16,00			LARA INOX 580	14	352 netto 432,96 brutto	P
 REMODEX	0,1	1	17,50			LARA INOX 1100	14	420 netto 516,60 brutto	P
 REMODEX	0,045	1	16,30			LARA INOX SQ	14	436 netto 536,28 brutto	P
	0,07	2	8,40			LENA 580 TABLE alu	14	138 netto 169,74 brutto	P
						LENA 580 TABLE kwarc	7	138 netto 169,74 brutto	EX
						LENA 580 TABLE chrome	7	153 netto 188,19 brutto	P, EX
REMODEX	0,07	2	8,30			LENA alu	21	149 netto 183,27 brutto	P
						LENA kwarc	7	149 netto 183,27 brutto	EX
						LENA chrome	7	164 netto 201,72 brutto	P, EX
REMODEX	0,26	2	8,80			LENA 1100 alu	21	182 netto 223,86 brutto	P
						LENA 1100 chrome	14	196 netto 241,08 brutto	P

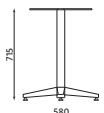









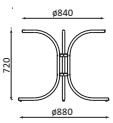

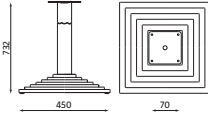

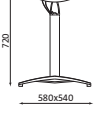

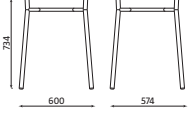

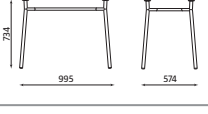

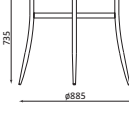
oferta: P – premium, S – standard, EX – express

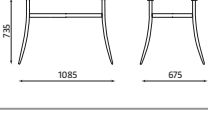
ważne informacje	objętość kartonu [m ³]	ilość w kartonie [szt.]	waga netto [kg]	MODEL wymiary w mm			TERMIN REALIZACJI	CENA [zł]	OFERTA
	0,07	2	17,6			LENA OUTDOORS	ZP	229 netto 281,67 brutto	P
REMODEX	0,03	1	6,00			MELBA TABLE alu	21	223 netto 274,29 brutto	P
						MELBA TABLE chrome	21	249 netto 306,27 brutto	P
REMODEX	0,03	1	5,10			MELBA 80 TABLE alu	21	219 netto 269,37 brutto	P
						MELBA 80 TABLE chrome	21	245 netto 301,35 brutto	P
REMODEX	0,03	1	7,90			MELBA DUO TABLE alu	21	247 netto 303,81 brutto	P
						MELBA DUO TABLE chrome	21	276 netto 339,48 brutto	P
	0,03	1	3,00			MELLO TABLE alu	21	146 netto 179,58 brutto	P
						MELLO TABLE chrome	21	175 netto 215,25 brutto	P
REMODEX	0,04	1	8,20			MOLINO TABLE alu	21	298 netto 366,54 brutto	P
						MOLINO TABLE chrome	21	355 netto 436,65 brutto	P
REMODEX	0,07	1	9,80			MOLINO DUO TABLE alu	21	342 netto 420,66 brutto	P
						MOLINO DUO TABLE chrome	21	399 netto 490,77 brutto	P
REMODEX	0,27	1	3,60			PINACOLADA TABLE chrome	14	144 netto 177,12 brutto	P
REMODEX	0,05	1	4,10			ROZANA alu	21	115 netto 141,45 brutto	S
						ROZANA chrome	14	131 netto 161,13 brutto	S
	0,088	2	2,20			SKY TABLE aluminium	7	157 netto 193,11 brutto	P, EX

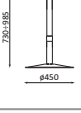

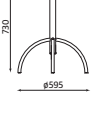
Produkty posiadają Atest Badań Wytrzymałościowych.

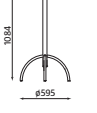

Nowy Styl zastrzega sobie prawo do zmian: konstrukcyjnych, wymiarów, terminów dostaw; usunięcia produktów i zmian w palecie wykończeń.

ważne informacje	objętość kartonu [m ³]	ilość w kartonie [szt.]	waga netto [kg]	MODEL wymiary w mm		TERMIN REALIZACJI	CENA [zł]	OFERTA	
REMODEX	0,03	1	5,40	 		SONIA alu	21	144 netto 177,12 brutto	S
						SONIA black	ZP	140 netto 172,20 brutto	S
						SONIA chrome	14	149 netto 183,27 brutto	S
REMODEX	0,05	1	20,10	 		SQUERTO A TABLE alu	21	406 netto 499,38 brutto	P
						SQUERTO A TABLE chrome	14	411 netto 505,53 brutto	P
	0,049	1	5,11	  		SUNNY TABLE aluminium	14	398 netto 489,54 brutto	P
REMODEX	0,08	1	5,40	 		TIRAMISU TABLE alu	21	181 netto 222,63 brutto	P
						TIRAMISU TABLE chrome	7	206 netto 253,38 brutto	P, EX
REMODEX	0,08	1	6,10	 		TIRAMISU DUO TABLE alu	21	193 netto 237,39 brutto	P
						TIRAMISU DUO TABLE chrome	7	217 netto 266,91 brutto	P, EX
REMODEX	0,08	1	5,30	 		TRACY alu	21	144 netto 177,12 brutto	P
						TRACY chrome	7	159 netto 195,57 brutto	P, EX
REMODEX	0,10	1	5,80	 		TRACY DUO alu	21	170 netto 209,10 brutto	P
						TRACY DUO chrome	7	189 netto 232,47 brutto	P, EX
REMODEX	0,07	2	9,40	 		UP&DOWN TABLE chrome	ZP	263 netto 323,49 brutto	P
REMODEX	0,15	2	3,52	 		WIKTOR alu	21	114 netto 140,22 brutto	S
						WIKTOR chrome	7	122 netto 150,06 brutto	S, EX
	0,23	2	4,00	 		WIKTOR 1100 alu	21	123 netto 151,29 brutto	S
						WIKTOR 1100 chrome	14	131 netto 161,13 brutto	S





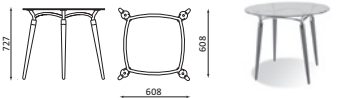
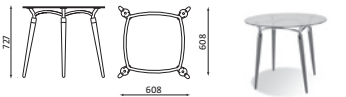
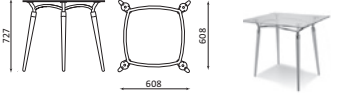
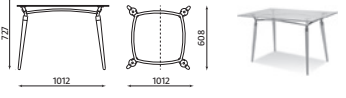
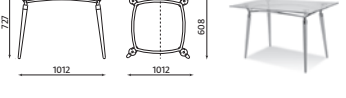
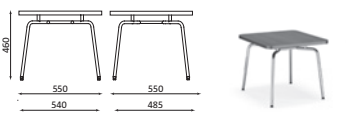

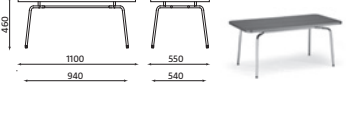
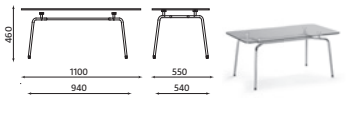





oferta: P – premium, S – standard, EX – express

ważne informacje	objętość kartonu [m ³]	ilość w kartonie [szt.]	waga netto [kg]	MODEL wymiary w mm			TERMIN REALIZACJI	CENA [Zł]	OFERTA
REMODEX	0,04 + 0,02 blat	1	18,70			DORINO TABLE alu	ZP	654 netto 804,42 brutto	P
						DORINO TABLE chrome	ZP	683 netto 840,09 brutto	P
REMODEX	0,06 + 0,03 blat	1	26,00			DORINO DUO TABLE alu	ZP	813 netto 999,99 brutto	P
						DORINO DUO TABLE chrome	ZP	839 netto 1031,97 brutto	P
	0,09	1	15,20			ERYK chrome 1200×500	14	474 netto 583,02 brutto	P
REMODEX	0,09	1	18,00			ERYK chrome 1200×600	14	482 netto 592,86 brutto	P
	0,12	1	25,60			ERYK chrome 1200×800	14	526 netto 646,98 brutto	P
REMODEX	0,09	1	25,00			RICO TABLE-2 alu	7	360 netto 442,80 brutto	S, EX
						RICO TABLE-2 black	7	347 netto 426,81 brutto	S, EX
REMODEX	0,1	1	27,60			RICO TABLE-3 alu	7	386 netto 474,78 brutto	S, EX
						RICO TABLE-3 black	7	368 netto 452,64 brutto	S, EX
REMODEX	0,11	1	39,60			RICO TABLE-4 alu	7	412 netto 506,76 brutto	S, EX
						RICO TABLE-4 black	7	388 netto 477,24 brutto	S, EX













ważne informacje	objętość kartonu [m ³]	liczba w kartonie [szt.]	waga netto [kg]	MODEL wymiary w mm 	TERMIN REALIZACJI	CENA MODELU W ZALEŻNOŚCI OD WYKOŃCZENIA [zł]			OFERTA	
						szkło przezroczyste	szkło matowe	melamina		
REMODEX	0,06 + blat	1	4,90 + blat		ALGEO TABLE Ø 800	21	840 netto 1033,20 brutto			P
REMODEX	0,06 + blat	1	4,90 + blat		ALGEO TABLE Ø 900	21	870 netto 1070,10 brutto			P
REMODEX	0,06 + blat	1	4,80 + blat		ALGEO TABLE 800×800	21	810 netto 996,30 brutto			P
REMODEX	0,11 + blat	1	5,50 + blat		ALGEO DUO TABLE 800×1200	21	890 netto 1094,70 brutto			P
REMODEX	0,11 + blat	1	5,50 + blat		ALGEO DUO TABLE 800×1400	21	930 netto 1143,90 brutto			P
REMODEX	0,2	1	8,60		HELLO! TABLE MA alu	21			270 netto 332,10 brutto	P
					HELLO! TABLE MA chrome	21			302 netto 371,46 brutto	P
REMODEX	0,2	1	10,70		HELLO! TABLE GL alu	21	569 netto 699,87 brutto	633 netto 778,59 brutto		P
					HELLO! TABLE GL chrome	21	600 netto 738,00 brutto	664 netto 816,72 brutto		P
REMODEX	0,4	1	14,55		HELLO! TABLE DUO MA alu	21			340 netto 418,20 brutto	P
					HELLO! TABLE DUO MA chrome	21			387 netto 476,01 brutto	P
REMODEX	0,4	1	19,05		HELLO! TABLE DUO GL alu	21	765 netto 940,95 brutto	872 netto 1072,56 brutto		P
					HELLO! TABLE DUO GL chrome	21	813 netto 999,99 brutto	919 netto 1130,37 brutto		P

oferta: P – premium, S – standard, EX – express

objętość kartonu [m ²]	ilość w kartonie [szt.]	waga netto [kg]	KSZTAŁT	WYMIAR [mm]	PROFIL [mm]	TERMIN REALIZACJI	CENA [zł]
							W.09, W.106, W.213, W.038, W.019, W.077, W.011, W.001, W.107, W.070, W.052, W.067, W.074, W.132, W.142, W.131
0,01	1	4,30		Ø600		ZP	132 netto 162,36 brutto
0,03	1	7,60		Ø800		ZP	166 netto 204,18 brutto
0,03	1	10,00		Ø900		ZP	217 netto 266,91 brutto
0,03	1	10,00		800×800		ZP	258 netto 317,34 brutto
0,03	1	12,70		700×1100		ZP	269 netto 330,87 brutto
0,04	1	15,20		800×1200		ZP	395 netto 485,85 brutto

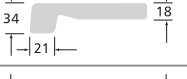
DEKORY BLATÓW **topalit** AUSTRIA DRUGA GRUPA CENOWA

objętość kartonu [m ²]	ilość w kartonie [szt.]	waga netto [kg]	KSZTAŁT	WYMIAR [mm]	PROFIL [mm]	TERMIN REALIZACJI	CENA [zł]
							W.055
0,01	1	4,30		Ø600		ZP	147 netto 180,81 brutto
0,03	1	7,60		Ø800		ZP	186 netto 228,78 brutto
0,03	1	10,00		Ø900		ZP	249 netto 306,27 brutto
0,03	1	10,00		800×800		ZP	309 netto 380,07 brutto
0,03	1	12,70		700×1100		ZP	322 netto 396,06 brutto
0,04	1	15,20		800×1200		ZP	474 netto 583,02 brutto







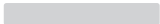

oferta: P – premium, S – standard, EX – express

TERMIN REALIZACJI w dniach kalendarzowych.

ZP – ZA POTWIERDZENIEM – oznacza każdorazowe uzgadnianie terminu realizacji z Działem Handlowym.

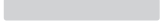



STANDARDOWE BLATY MELAMINOWE

(obrzeże blatu z tworzywa ABS w kolorze identycznym jak powierzchnia blatu)

objętość kartonu [m ³]	ilość w kartonie [szt.]	waga netto [kg]	KSZTAŁT	WYMIAR [mm]	PROFIL [mm]	2 lata na produkt GWARANCJA	TERMIN REALIZACJI	CENA [zł]	
								MA-NE, MA-NB, MA-CV, MA-NN, MA-NT, MA-NG MA-MP, MA-MS	MA-BI, MA-CC
0,01	1	4,95		Ø600	 25		14	74 netto 91,02 brutto	88 netto 108,24 brutto
0,03	1	8,80		Ø800	 25		14	117 netto 143,91 brutto	134 netto 164,82 brutto
0,03	1	11,00		600×800	 25		14	90 netto 110,70 brutto	107 netto 131,61 brutto
0,03	1	13,75		800×800	 25		14	117 netto 143,91 brutto	134 netto 164,82 brutto
0,04	1	16,15		800×1200	 25		14	160 netto 196,80 brutto	180 netto 221,40 brutto



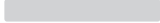

BLATY MELAMINOWE TOP 36

(obrzeże aluminiowe)







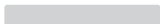



objętość kartonu [m ³]	ilość w kartonie [szt.]	waga netto [kg]	KSZTAŁT	WYMIAR [mm]	PROFIL [mm]	2 lata na produkt GWARANCJA	TERMIN REALIZACJI	CENA [zł]	
								MA-NG, MA-NE, MA-NT, MA-BI, MA-CC	
0,03	1	5,10		Ø600	 36		14	179 netto 220,17 brutto	
0,05	1	9,40		Ø800	 36		14	244 netto 300,12 brutto	
0,05	1	11,20		800×800	 36		14	244 netto 300,12 brutto	

BLATY MELAMINOWE TOP 50

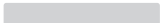



(obrzeże blatu z tworzywa ABS w kolorze identycznym jak powierzchnia blatu)

objętość kartonu [m ³]	ilość w kartonie [szt.]	waga netto [kg]	KSZTAŁT	WYMIAR [mm]	PROFIL [mm]	2 lata na produkt GWARANCJA	TERMIN REALIZACJI	CENA [zł]	
								MA-NG, MA-NE, MA-BI, MA-CC	
0,03	1	7,50		Ø600	 50		14	153 netto 188,19 brutto	
0,05	1	12,40		Ø800	 50		14	217 netto 266,91 brutto	
0,05	1	15,20		800×800	 50		14	217 netto 266,91 brutto	







objętość kartonu [m ³]	ilość w kartonie [szt.]	waga netto [kg]	KSZTAŁT	WYMIAR [mm]	PROFIL [mm]		TERMIN REALIZACJI	CENA [zł]
0,01	1	4,80		Ø600		22	ZP	286 netto 351,78 brutto
0,02	1	7,95		Ø800		22	ZP	415 netto 510,45 brutto
0,02	1	10,00		Ø900		22	ZP	481 netto 591,63 brutto
0,02	1	11,00		800×800		22	ZP	415 netto 510,45 brutto
0,03	1	16,50		800×1200		22	ZP	538 netto 661,74 brutto











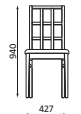

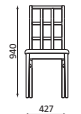

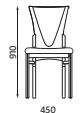

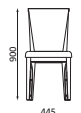

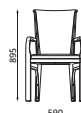

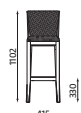

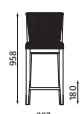

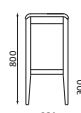
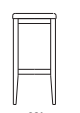

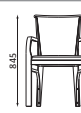
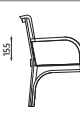
BLATY SZKLANE

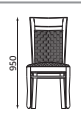
objętość kartonu [m ³]	ilość w kartonie [szt.]	waga netto [kg]	KSZTAŁT	WYMIAR [mm]	PROFIL [mm]		TERMIN REALIZACJI	CENA [zł]
0,02	1	16,40		Ø900		10	21	320 netto 393,60 brutto
0,03	1	10,85		Ø800 tylko dla Mello Table		10	21	440 netto 541,20 brutto

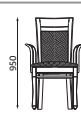
BLATY SZKLANE DO STOŁÓW ALGEO I ALGEO DUO

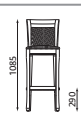
objętość kartonu [m ³]	ilość w kartonie [szt.]	waga netto [kg]	ROZMIARY I KSZTATY BLATÓW	
0,01	1	13,90	Ø800	
0,02	1	17,20	Ø900	
0,01	1	17,30	800×800	
0,02	1	25,20	800×1200	
0,03	1	25,90	800×1400	

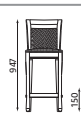
oferta: P – premium, S – standard, EX – express











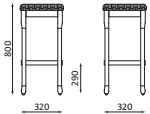

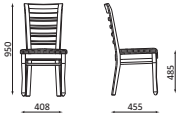

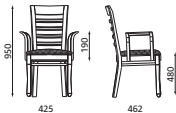



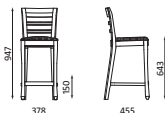

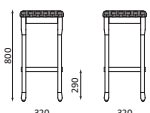

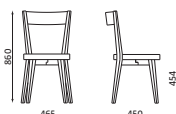
ważne informacje	objętość kartonu [m ³]	ilość w kartonie [szt.]	waga netto [kg]	siedzisko szerokość [mm]	siedzisko głębokość [mm]	MODEL			wymiary w mm	
										
REMODEX	0,32	2	5,40	460	400				BERGAMO 1B	
REMODEX	0,37	2	5,70	465	465				CRACOW 1B	
REMODEX	0,37	2	7,90	460	410				FLORENCE 1C	
REMODEX	0,36	1	8,30	488	443				FLORENCE 2C	
REMODEX	0,25	1	9,00	395	380				FLORENCE 3pC	
REMODEX	0,22	1	7,50	395	380				FLORENCE 4rC	
REMODEX	0,13	1	7,20	373	373				FLORENCE 5B	
REMODEX	0,33	1	8,45	520	443				FLORENCE 6C	
REMODEX	0,37	2	6,65	460	415				LISBON 1C	
REMODEX	0,42	1	8,00	478	425				LISBON 2C	
REMODEX	0,25	1	7,10	400	380				LISBON 3C	
REMODEX	0,22	1	6,85	400	380				LISBON 4C	

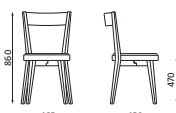

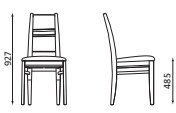
TERMIN REALIZACJI	CENA MODELU W ZALEŻNOŚCI OD WYKOŃCZENIA [zł]					OFERTA
	DREWNO	SENSE (SE)	TRENDY (TE)	INFINITY (IN)	SKÓRA LICOWA (SD)	
14		284 netto 349,32 brutto	303 netto 372,69 brutto	303 netto 372,69 brutto	346 netto 425,58 brutto	P
14		376 netto 462,48 brutto	394 netto 484,62 brutto	394 netto 484,62 brutto	437 netto 537,51 brutto	P
21		443 netto 544,89 brutto	466 netto 573,18 brutto	466 netto 573,18 brutto		P
21		525 netto 645,75 brutto	548 netto 674,04 brutto	548 netto 674,04 brutto		P
21		479 netto 589,17 brutto	500 netto 615,00 brutto	500 netto 615,00 brutto		P
21		466 netto 573,18 brutto	487 netto 599,01 brutto	487 netto 599,01 brutto		P
21		281 netto 345,63 brutto	297 netto 365,31 brutto	297 netto 365,31 brutto		P
28		654 netto 804,42 brutto	687 netto 845,01 brutto	687 netto 845,01 brutto		P
21		427 netto 525,21 brutto	451 netto 554,73 brutto	451 netto 554,73 brutto		P
21		516 netto 634,68 brutto	541 netto 665,43 brutto	541 netto 665,43 brutto		P
21		453 netto 557,19 brutto	472 netto 580,56 brutto	472 netto 580,56 brutto		P
21		444 netto 546,12 brutto	465 netto 571,95 brutto	465 netto 571,95 brutto		P

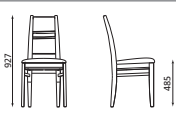
drewno: 1.127, 4.037, 4.047, 4.041, 4.038, 1.126

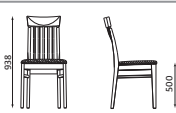
oferta: P – premium, S – standard, EX – express











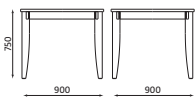



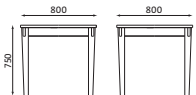

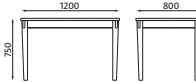

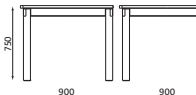

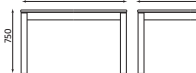

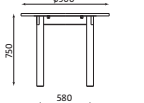
ważne informacje	objętość kartonu [m ³]	ilość w kartonie [szt.]	waga netto [kg]	siedzisko szerokość [mm]	siedzisko głębokość [mm]	MODEL		wymiary w mm	
REMODEX	0,13	1	5,56	380	380			LISBON 5B	
REMODEX	0,37	2	6,90	460	415			MADRID 1B	
REMODEX	0,42	1	7,85	478	425			MADRID 2B	
REMODEX	0,25	1	7,30	400	380			MADRID 3B	
REMODEX	0,22	1	6,80	400	380			MADRID 4B	
REMODEX	0,13	1	5,56	380	380			MADRID 5B	
REMODEX	0,32	2	5,15	Ø430				PALERMO 1A	
REMODEX	0,32	2	5,40	Ø430				PALERMO 1B	
REMODEX	0,32	2	6,00	455	400			PARIS 1B	
REMODEX	0,32	2	6,05	455	400			PARIS 1C	
REMODEX	0,34	2	5,65	470	410			VIENNA 1B	

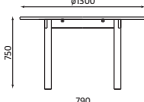

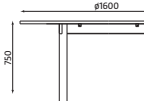
TERMIN REALIZACJI	CENA MODELU W ZALEŻNOŚCI OD WYKOŃCZENIA [zł]					OFERTA
	DREWNO	SENSE (SE)	TRENDY (TE)	INFINITY (IN)	SKÓRA LICOWA (SD)	
21		281 netto 345,63 brutto	297 netto 365,31 brutto	297 netto 365,31 brutto		P
21		390 netto 479,70 brutto	409 netto 503,07 brutto	409 netto 503,07 brutto	451 netto 554,73 brutto	P
21		479 netto 589,17 brutto	499 netto 613,77 brutto	499 netto 613,77 brutto	541 netto 665,43 brutto	P
21		415 netto 510,45 brutto	432 netto 531,36 brutto	432 netto 531,36 brutto	467 netto 574,41 brutto	P
21		405 netto 498,15 brutto	423 netto 520,29 brutto	423 netto 520,29 brutto	458 netto 563,34 brutto	P
21		281 netto 345,63 brutto	297 netto 365,31 brutto	297 netto 365,31 brutto	333 netto 409,59 brutto	P
21	395 netto 485,85 brutto					P
21		422 netto 519,06 brutto	440 netto 541,20 brutto	440 netto 541,20 brutto	483 netto 594,09 brutto	P
14		371 netto 456,33 brutto	391 netto 480,93 brutto	391 netto 480,93 brutto	433 netto 532,59 brutto	P
14		400 netto 492,00 brutto	424 netto 521,52 brutto	424 netto 521,52 brutto		P
14		360 netto 442,80 brutto	379 netto 466,17 brutto	379 netto 466,17 brutto	422 netto 519,06 brutto	P

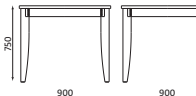
drewno: 1.127, 4.037, 4.047, 4.041, 4.038, 1.126

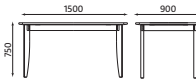
oferta: P – premium, S – standard, EX – express

ważne informacje	objętość kartonu [m ³]	ilość w kartonie [szt.]	waga netto [kg]	MODEL wymiary w mm			TERMIN REALIZACJI	CENA	OFERTA
REMODEX	0,14	1	30,00			ALSACE NF TABLE MA 900×900	ZP	739 netto 908,90 brutto	P
REMODEX	0,21	1	35,00			ALSACE NF TABLE MA 900×1500	ZP	851 netto 1046,73 brutto	P
REMODEX	0,11	1	23,60			CATALONIA NF TABLE MA 800×800	ZP	642 netto 789,66 brutto	P
REMODEX	0,17	1	30,60			CATALONIA NF TABLE MA 800×1200	ZP	719 netto 884,37 brutto	P
REMODEX	0,14	1	30,00			MODERN NF TABLE MA 900×900	Z1	774 netto 952,02 brutto	P
REMODEX	0,17	1	34,80			MODERN NF TABLE MA 800×1200	Z1	807 netto 992,61 brutto	P
 REMODEX	0,14	1	25,00			MODERN NF TABLE MA Ø900	ZP	714 netto 878,22 brutto	P
 REMODEX	0,27	1	36,00			MODERN NF TABLE MA Ø1300	ZP	893 netto 1098,39 brutto	P
 REMODEX	0,41	1	48,00			MODERN NF TABLE MA Ø1600	ZP	1124 netto 1382,52 brutto	P
REMODEX	0,14	1	30,00			TUSCANY NF TABLE MA 900×900	ZP	739 netto 908,97 brutto	P
REMODEX	0,21	1	36,00			TUSCANY NF TABLE MA 900×1500	ZP	851 netto 1046,73 brutto	P

KOLORY BLATÓW MELAMINOWYCH I ODPOWIADAJĄCE IM KOLORY PODSTAW*

kolor blatu	kolor podstawy
MA-NB	1.127
MA-CV	4.037
MA-NG	1.126

* Stoły posiadają blaty wykonane z melaminy. Nogi i oskrzynia stołu są wykonane z drewna litego. Melamina i drewno to różne surowce, zatem kolor i struktura blatu oraz podstawy może się różnić. Stoły te rekomendowane są do wnętrz hotelowych, w których blaty stołów zakrywa się obrusami. Stoły dostępne w 3 kolorach.



Produkty posiadają Atest Badań Wytrzymałościowych.
Nowy Styl zastrzega sobie prawo do zmian: konstrukcyjnych, wymiarów, terminów dostaw; usunięcia produktów i zmian w palecie wykończeń.

ORGANIZACJA ZESPOŁU HANDLOWCÓW

Mapa podziału na regiony



REGION	MENEDŻER HANDLOWY	HANDLOWIEC W KROŚNIE
1	tel. 510 005 461	tel. (013) 43 76 119
2	tel. 510 005 469	tel. (013) 43 76 229
3	tel. 510 005 463	tel. (013) 43 76 146
4	tel. 510 005 464	tel. (013) 43 76 246
5	tel. 510 005 466	tel. (013) 43 76 149
6	tel. 510 005 465	tel. (013) 43 76 132
7	tel. 510 005 467	tel. (013) 43 76 232
8	tel. 510 005 476	tel. (013) 43 76 218

fax (013) 43 62 **603**

EDYCJA 2

Data wydania:
marzec 2012

Nowy Styl
Dział Sprzedaży Krajowej
ul. Pużaka 12
38-400 Krosno
kraj@nowystylgroup.com

Centrum informacji:
tel. 0 801 177 291

→ www.nowystyl.pl

NOWY STYL GROUP

Marka Nowy Styl
należy do oferty Nowy Styl Group

www.nowystylgroup.com

> **więcej możliwości**