



COMPLEMENTARY OFFER

 mdd



BASIC STORAGES

4-5



BASIC PEDESTALS

6-7



STANDARD STORAGES

8-11



PRO STORAGES

12-15



FILE/METAL SHELVES

16-17



TAMBOUR STORAGES

18-19



SLIDING DOOR

20-23



WARDROBE

24-25



GLOSS STORAGES

26-27



GLASS STORAGEES 28-29



SPECIAL STORAGEES 30-31



LOCKER STORAGEES 32-33



CARGO STORAGEES 34-35



STANDARD/PRO PEDESTALS 36-45



MULTIMEDIA STAND 46-47



LAMPS 48-49



HANGERS 50-51

**BASIC
STANDARD
PRO
STORAGEES
AND
PEDESTALS**



Space between shelves allow for free arrangement of binders or other documents

Handle — aluminium



- K5104** X 2 STORAGE 801/385/1833 (31 1/2" x 15 1/8" x 72 1/8")
- K5504** X 2 STORAGE 801/385/1833 (31 1/2" x 15 1/8" x 72 1/8")
- K5404** X 1 STORAGE 801/385/1833 (31 1/2" x 15 1/8" x 72 1/8")
- K1104** X 5 STACK - ON STORAGE 801/385/750 (31 1/2" x 15 1/8" x 29 1/2")
- K3404** X 2 STORAGE 801/385/1129 (31 1/2" x 15 1/8" x 44 1/2")
- K3504** X 1 STORAGE 801/385/1129 (31 1/2" x 15 1/8" x 44 1/2")
- LAV30L** X 1 VALDE RECEPTION DESK 2922/1486/1105 (115" x 58 1/2" x 43 1/2")
- WS05** X 1 HANGER 480/1700 (18 7/8" x 66 7/8")
- CAN11** X 1 CANOE LAMP 1105/360/360 (43 1/2" x 14 1/8" x 14 1/8")



BASIC STORAGES



Basic is an optimum and economical system of cabinets and shelves, with body available in three colours: aluminium, white and anthracite. The cabinets are available in the width of 800 mm and in 30H heights. The range is complemented with special cabinets such as a wardrobe, a tambour cabinet and a printer stand. By adding clear or frosted glass doors, one can build display cases. Simple construction and classic design make it possible to combine this furniture with other systems.



Basic pedestals can be mobile or fixed. The body of the pedestal is made of MFC available in three colours: white, aluminium or anthracite. The top drawer contains a removable pencil case for arranging office supplies. Among fixed pedestals, we offer pedestals for extending desk space with or without overhanging top.



A pedestal with a suspension files drawer has a mechanism adjusting the width of the frame so that one can hang files of various sizes

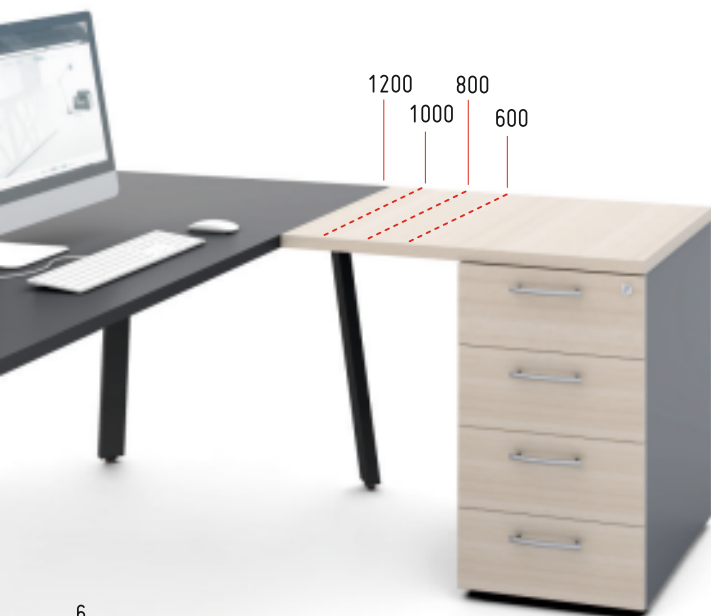

- KK774** X 2 PEDESTAL 402/800/740 (15 7/8" x 31 1/2" x 29 1/8")
- KT1064** X 1 PEDESTAL WITH TOP OVERHANG 1000 WIDE 1000/600/740 (39 3/8" x 23 5/8" x 29 1/8")
- ZBN16** X 1 YAN_Z BENCH 1600/1600/740 (63" x 63" x 29 1/8")
- ZUS16** X 1 SONIC PANEL 1590/38/350 (62 5/8" x 1 1/2" x 13 3/4")
- D1,D2,D3** FUNCTION RAIL ACCESSORIES
- S73** X 2 CPU STAND
- SAVA** X 1 CHAIR 660/610/1050-1150 (26" x 24" x 38 5/8" - 42 4/8")

BASIC PEDESTALS



STANDARD storage cabinets represent a group of multi-purpose cabinets for various applications. The modular build and a wide range of finishes make it possible to adapt the storage units to the space and function. **STANDARD** line includes storages and upper sections with open fronts, wing doors, tambour doors, sliding doors or glass doors. If you need to store large quantities of documents, we recommend cabinets with metal shelves or suspension files cabinets. The **STANDARD** line also has managerial cabinets designed for setting up personalised work stations, and also mobile cabinets which can be easily rearranged in a given interior depending on current needs.



A6106 X 2 STORAGE 1200/432/2185 (47 1/4" x 17" x 86")
 A6506 X 1 STORAGE 1200/432/2185 (47 1/4" x 17" x 86")
 A3104 X 3 STORAGE 801/432/1129 (31 1/2" x 17" x 44 1/2")
 PS80 X 2 MEETING TABLE Ø800/1100 (Ø 31 1/2" x 43 1/4")

STANDARD STORAGES



An espagnolette lock is fitted in 50H, 60H storage units in 1000 and 1200 mm widths. Other cabinets are fitted with patent locks



A solid back made of 18 mm MFC, PVC edge trim. The backs of the cabinets are made of MFC of the same colour as the body, offering a possibility of storages being used as partitions separating work areas



Patent lock, handle — aluminium



The cabinets may be levelled from the inside

A5104 X 2 STORAGE 801/432/1833 (31 1/2" x 17" x 72 1/8")
A58P2 X 1 STORAGE 402/432/1833 (15 7/8" x 17" x 72 1/8")
A4506 X 2 STORAGE 1200/432/1129 (47 1/4" x 17" x 58 1/4")
A4104 X 1 STORAGE 801/432/1481 (31 1/2" x 17" x 58 1/4")
A2508 X 1 STORAGE 1600/432/777 (63" x 17" x 30 5/8")
ZBN16 X 1 YAN_Z BENCH 1600/1600/740 (63" x 63" x 29 1/8")
ZUS16 X 1 SONIC PANEL 1590/38/350 (62 5/8" x 1 1/2" x 13 3/4")





STANDARD STORAGES

STANDARD storage cabinets enable user to have quick and easy access to stored documents and the top of the added cabinet expands the work surface playing the role of an extension.

Lockable cabinets have hinges with 110° opening optionally, 170° wide-angle hinges can be fitted





IA6105 X 2 STORAGE 1000/432/2185 (39 3/8" x 17" x 86")
IA6505 X 3 STORAGE 1000/432/2185 (39 3/8" x 17" x 86")
IA5504 X 1 STORAGE 801/432/1833 (31 1/2" x 17" x 72 1/8")
IA5505 X 1 STORAGE 1000/432/1833 (39 3/8" x 17" x 72 1/8")
IA5104 X 1 STORAGE 801/432/1833 (31 1/2" x 17" x 72 1/8")
IA3404 X 6 STORAGE 801/432/1129 (31 1/2" x 17" x 44 1/2")
B0Q34 X 2 OGL_Q BENCH 1600/1610/740 (63" x 63 3/8" x 29 1/8")
ZUS16 X 2 SONIC PANEL 1590/38/350 (62 5/8" x 1 1/2" x 13 3/4")
SAVA X 4 CHAIR 660/610/1050-1150 (26" x 24" x 38 5/8" - 42 4/8")
PLF10 X 2 MEETING TABLE Ø 1000/740 (Ø 39 3/8" x 29 1/8")
GAYA X 5 CHAIR 660/510/825 (19 2/8" x 20 2/8" x 32 7/8")
SNL16 X 4 SUNBEAM LAMP Ø 1440/410 (Ø 56 3/4" x 16 1/8")

PRO STORAGES

PRO line is the high-end solution offering unlimited options for arranging office space. The design of the cabinets and the materials used make it possible to create pleasant and functional spaces. Storage cabinets are available in five widths and four heights. A wide colour palette and the possibility of making diverse colour configurations gives one great freedom in designing the interior. All models can additionally be fitted with metal bases and wide-angle hinges to reinforce the cabinets and facilitate their daily use.



The back of the **PRO** cabinet is made of 18 mm MFC with PVC edge. The cabinets may be levelled from the inside. As an option, the **PRO** cabinets can be fitted with a metal base



IA4104 X 1 STORAGE 801/432/1481 (31 1/2" x 17" x 58 1/4")
IA3404 X 1 STORAGE 801/432/1481 (31 1/2" x 17" x 44 1/2")
IA2104 X 4 STORAGE 801/432/777 (31 1/2" x 17" x 30 5/8")
IA2902 X 2 STORAGE 402/432/777 (15 7/8" x 17" x 30 5/8")
IA5902 X 2 STORAGE 402/432/1833 (15 7/8" x 17" x 72 1/8")
IA56P2 X 1 STORAGE 402/432/1833 (15 7/8" x 17" x 72 1/8")
IA58P2 X 1 STORAGE 402/432/1833 (15 7/8" x 17" x 72 1/8")
IA5104 X 1 STORAGE 801/432/1833 (31 1/2" x 17" x 72 1/8")
IA5404 X 1 STORAGE 801/432/1833 (31 1/2" x 17" x 72 1/8")
B0Q04 X 1 DGI_Q DESK 1600/800/740 (63" x 31 1/2" x 29 1/8")



PRO STORAGES

PRO line enables one to design solutions dedicated for a specific work style. The colour schemes and details make it possible to arrange the interior to the user's taste and expectations. **PRO** cabinets are fitted with quick-fit hinges which are easy to adjust. By default, cabinets have hinges with 110° opening; optionally, 170° wide-angle hinges can be fitted. All types of **PRO** cabinets have espagnolette locks.



A54B4 X 1 FILING DRAWERS CABINET 801/432/1833 (31 1/2" x 17" x 72 1/8")
A54C4 X 1 FILING DRAWERS CABINET 801/432/1833 (31 1/2" x 17" x 72 1/8")
IA3F04 X 1 FILING DRAWERS CABINET 801/432/1129 (31 1/2" x 17" x 44 1/2")
IA3506TM X 1 STORAGE AND FILING CABINET WITH METAL SHELVES 1200/432/1129 (47 1/4" x 17" x 44 1/2")

IA6F04 X 1 FILING DRAWERS CABINET 1000/432/1129 (39 3/8" x 17" x 44 1/2")
B0Q34 X 2 OG_Q BENCH 1600/1610/740 (63" x 63 3/8" x 29 1/8")
ZUS16 X 2 SONIC PANEL 1590/38/350 (62 5/8" x 1 1/2" x 13 3/4")
D1 FUNCTIONAL RAIL ACCESSORIES
S83 X 1 PC HOLDER
SAVA X 2 CHAIR 660/610/1050-1150 (26" x 24" x 38 5/8"-42 4/8")



FILE/METAL SHELF STORAGE

Cabinets designed to hold large quantities of office documents.

The cabinet system offers two ways to store documents.

The storage cabinets are available in **STANDARD** and **PRO** lines.

Cabinets with metal shelves for binders which can be arranged in rows. In addition, the shelves have edges which work as frames for suspension files.

The metal shelf for hanging files is available in the aluminium colour.
The maximum shelf load is 41 kg



Cabinets with suspension files drawers.
Ball runners , max. load 45kg, 100% extraction



A3L06 X 2 TAMBOUR STORAGE 1200/432/1129 (47 1/4" x 17" x 44 1/2")



A2L06 TAMBOUR STORAGE 1200/432/740 (47 1/4" x 17" x 29 1/8")



TAMBOUR STORAGES



IA4L6 X 2 TAMBOUR STORAGE 1200/432/1481 (47 1/4" x 17" x 58 1/4")
IA2L16 X 1 TAMBOUR STORAGE 1610/432/740 (63 3/8" x 17" x 29 1/8")
BOQ33 X 1 OGI_Q BENCH 1400/1610/740 (55 1/8" x 63 3/8" x 29 1/8")
ZUS14 X 1 SONIC PANEL 1390/38/350 (54 3/4" x 1 1/2" x 13 3/4")
D1 FUNCTIONAL RAIL ACCESSORIES
S73 X 1 CPU STAND
SAVA X 1 CHAIR 660/610/1050-1150 (26" x 24" x 38 5/8"-42 4/8")

TAMBOUR STORAGES are an effective solution wherever tight space is a challenge. They were designed for interiors where it is necessary to effectively use a limited area. The front tambour comes in three colours: black, aluminium and white. It is fitted with a patent lock and a strip handle. In addition, the storage cabinet can be set on a metal base to reinforce its structure. **TAMBOUR STORAGE** cabinets are available in **STANDARD** and **PRO** lines.



SLIDING DOOR STORAGES are used in small spaces. Owing to the self-closing system, the sliding doors are quiet and save space. Storage units are available in four heights and three widths. The doors are fitted with patent locks. The **STANDARD** line cabinet is equipped with a handle whereas in the **PRO** line, handles are optional accessories.



- IA1P06 X 3 SLIDING DOOR STORAGE 1200/432/750 (47 1/4" x 17" x 29 1/2")
- IA5P06 X 2 SLIDING DOOR STORAGE 1200/432/1833 (47 1/4" x 17" x 72 1/8")
- IA3P06 X 1 SLIDING DOOR STORAGE 1200/432/1129 (47 1/4" x 17" x 44 1/2")
- IA2P16 X 1 SLIDING DOOR STORAGE 1610/432/740 (63 3/8" x 17" x 29 1/8")
- BOU33 X 1 OGI_U BENCH 1400/1610/740 (55 1/8" x 63 3/8" x 29 1/8")
- ZUT34 X 1 TWIN FABRIC PANEL FOR BENCH 1390/30/360 (54 3/4" x 1 1/8" x 14 1/8")
- SAVA X 2 CHAIR 660/610/1050-1150 (26" x 24" x 38 5/8" - 42 4/8")
- CAN11 X 1 CANOE LAMP 1105/360/360 (43 1/2" x 14 1/8" x 14 1/8")

SLIDING DOOR STORAGES





ZS02 X 1 MANAGERIAL STORAGE 2000/434/1129 (78 3/4" x 17 1/8" x 44 1/2")
ZS01 X 1 ADDITIONAL DRAWER 428/385/403 (16 7/8" x 15 1/8" x 15 7/8")

ZS01 X 1 MANAGERIAL STORAGE 2000/434/1129 (78 3/4" x 17 1/8" x 44 1/2")
ZS01 X 1 ADDITIONAL DRAWER 428/385/403 (16 7/8" x 15 1/8" x 15 7/8")



SLIDING DOOR STORAGES

SLIDING DOOR STORAGES represent a group of storage units distinguished by their simple form and design, but nevertheless universal and flexible in application. The set consists of a ZS01 cabinet with the front made of metal pattern combined with HPL laminate, a ZS02 cabinet with the front made of MFC covered with glossy HPL laminate available in nine vivid colours, and a ZS03 cabinet with the front made of MFC available in pastel and wood finishes. The interior of a cabinet may be fitted with drawers. The sliding doors have a metal self-closing mechanism facilitating soft closing.

ZS03 X 1 MANAGERIAL STORAGE 2000/434/1129 (78 3/4" x 17 1/8" x 44 1/2")
ZS01 X 1 ADDITIONAL DRAWER 428/385/403 (16 7/8" x 15 1/8" x 15 7/8")



A6204 X 2 WARDROBE 801/600/1833 (31 1/2" x 23 5/8" x 72")
LIN25 X 1 LINEA RECEPTION DESK 2456/824/1105 (96 3/4" x 32 1/2" x 43 1/2")
CAN11 X 1 CANOE LAMP 1105/360/360 (43 1/2" x 14 1/8" x 14 1/8")





WARDROBE

A **WARDROBE** is an essential closet for any office. The **STANDARD** and **PRO** lines include four wardrobe models differing in dimensions and interior arrangement. The finishes and sizes of the wardrobes match the **PRO** and **STANDARD** ranges and make it possible to integrate the wardrobes in every room.



Garment hanger bar



Pull-out hanger

A52P6 X 1 801/3/432/1833 (31 1/2" x 17" x 72 1/8")
A57P3 X 1 602/432/1833 (23 3/4" x 17" x 72 1/8")



A2104HZ X 3 HPL FRONT STORAGE 801/432/777 (31 1/2" x 17" x 30 5/8")
LIN43 X 1 LINEA RECEPTION DESK 2844/850/1105 (112" x 33 1/2" x 43 1/2")
MM-PU X 3 + **MM-ON** X 3 + **MM-PO** X 3 LOUNGE 1950/720/770 (76 6/8" x 28 3/8" x 30 3/8")





GLOSS DOOR STORAGES

GLOSS STORAGE units represent a range of cabinets with high-gloss HPL laminate finish on fronts. There are ten different colours available. They range from low-key grey, graphite to vivid green and pink. The body of the cabinet can be black, aluminium, white or anthracite. Such a colour scheme makes it possible to combine the cabinets with other components of the PRO or STANDARD line. The cabinet doors are fitted with a patent lock and a push-to-open system. Optionally, can be equipped with glass top.

A3104HZ X 2 HPL FRONT STORAGE 801/432/1129 (31 1/2" x 17" x 44 1/2")
A8006T X 2 GLASS TOP 800/432/33 (31 1/2" x 17" x 1 1/4")



A5104HZ X 3 HPL FRONT STORAGE 801/432/1833 (31 1/2" x 17" x 72 1/8")
A5404HZ X 1 HPL FRONT STORAGE 801/432/1833 (31 1/2" x 17" x 72 1/8")





A5504 X 2 STORAGE 800/432/1833 (31 1/2" x 17" x 72 1/8")
AS500 X 2 GLASS DOOR WITH ALUMINIUM FRAME, TRANSPARENT, TEMPORED GLASS 800/20/1754 (31 1/2" x 3/4" x 69")
A5404 X 1 STORAGE 800/432/1833 (31 1/2" x 17" x 72 1/8")
AS300 X 1 GLASS DOOR WITH ALUMINIUM FRAME FROSTED TEMPERED GLASS 800/20/1050 (31 1/2" x 3/4" x 41 3/8")
GAYA X 4 CHAIR 660/510/825 (19 2/8" x 20 2/8" x 32 7/8")

GLASS DOORS complement the range of STANDARD and PRO storages. There are two types of glass available: clear and opaque, with an aluminium frame, or with no frame. Glass elements can be fitted in cabinets and bookcases of 400 mm and 800 mm in width as well as 30H and 50H in height, creating display cabinets which make excellent supplementary equipment of offices or exhibition places.

GLASS DOOR STORAGES

AS300 GLASS DOOR WITH ALUMINIUM FRAME FROSTED TEMPERED GLASS
800/20/1050 (31 1/2" x 3/4" x 41 3/8")



IM300 GLASS DOOR WITH ALUMINIUM FRAME, TRANSPARENT TEMPERED GLASS
800/20/1050 (31 1/2" x 3/4" x 41 3/8")



A3504 X 3 STORAGE 801/432/1129 (31 1/2" x 17" x 44 1/2")
AS31 X 4 GLASS DOOR 397/5/1050 (15 5/8" x 1/4" x 41 3/8")



A12M X 1 MANAGERIAL STORAGE 1600/434/600 (63" x 17 1/8" x 23 5/8")

SPECIAL STORAGES are a group of multi-purpose storages which can be used in any situation: for ad hoc meetings, or individual work. A characteristic feature of these storages is that they can be adapted to various work styles and individual needs of the user. They can be combined with PRO or STANDARD storage units.



A14M X 1 MANAGERIAL STORAGE 1400/432/600 (55 1/8" x 17" x 23 5/8")

A120M X 1 MANAGERIAL STORAGE 1200/432/599 (47 1/4" x 17" x 23 5/8")



S85 X 1 PRINTER STORAGE 710/600/600 (28" x 23 5/8" x 23 5/8")



In energetic teams, there may be a need for a quick rearrangement of the office, and the A3R02 mobile storage unit makes it possible to modify the work space within minutes. It is an ideal solution for meeting rooms and an ergonomic tool for delivering multimedia presentations.

A3R02 X 1 MOBILE STORAGE MULTIFUNCTION 550/550/1188 (21 5/8" x 21 5/8" x 46 3/4")
BUN24L X 1 MEETING TABLE YAN_C 1400/1300/740 (55 1/8" x 51 1/8" x 29 1/8")
BUN24S X 1 MEETING TABLE YAN_C 1400/1300/740 (55 1/8" x 51 1/8" x 29 1/8")
BUN24P X 1 MEETING TABLE YAN_C 1400/1300/740 (55 1/8" x 51 1/8" x 29 1/8")
GAYA X 4 CHAIR 660/510/825 (19 2/8" x 20 2/8" x 32 7/8")

SPECIAL STORAGES





LOK08 X 7 LOCKER TYPE STORAGE 801/432/1619 (31 1/2" x 17" x 63 3/4")



Code lock



Standard digital combination lock

LOCKER STORAGES

LOCKERS are an answer to a growing need for optimising the office space.

Such units often replace pedestals in large offices. The locker is mainly designed for storing personal artefacts. Lockers can be assigned to specific individuals, and correspondence slots are an additional advantage. Apart from the traditional lock, the locker can be fitted with a combination lock or an electronic one. Lockers are available as 40H and 50H modules, 800 mm in width.

LOK10 X 11 LOCKER TYPE STORAGE 801/432/2010 (31 1/2" x 17" x 79 1/8")
CAN11 X1 CANOE LAMP 1105/360/360 (43 1/2" x 14 1/8" x 14 1/8")
MM-PM X 4 LOUNGE 450/450/420 (17 3/4" x 17 3/4" x 16 1/2")



- KCD80L X 4 CARGO 402/800/1129 (15 7/8" x 31 1/2" x 44 1/2")
- KCD80P X 4 CARGO 402/800/1129 (15 7/8" x 31 1/2" x 44 1/2")
- KCD80SL X 2 CARGO 402/800/1129 (15 7/8" x 31 1/2" x 44 1/2")
- IKDT13 X 4 PEDESTAL 402/600/586 (15 7/8" x 23 5/8" x 23 1/8")
- IA3P08 X 2 SLIDING DOOR 1600/432/1129 (63" x 17" x 44 1/2")
- HPR2 X 2 HANDLES
- IA5506 X 3 STORAGE 1200/432/1833 (47 1/4" x 17" x 72 1/8")
- IA2505 X 3 STORAGE 1000/432/740 (39 3/8" x 17" x 30 5/8")
- BLN14L X 4 ELEMENT FOR DESK PAIRING 1400/1600/740 (55 1/8" x 63" x 29 1/8")
- PL180 X 1 EXTENTION 1800/60/2 (63" x 23 5/8" x 1 1/8")
- BZB14 X 1 DOUBLE DESK TOP 1400/1600/83 (55 1/8" x 63" x 3 1/4")
- ZUT34 X 5 TWIN FABRIC PANEL FOR BENCH 1390/30/360 (54 3/4" x 1 1/8" x 14 1/8")
- SNL16 X 4 SUNBEAM LAMP Ø 1440/410 (Ø 56 3/4" x 16 1/8")
- SAVA X 9 CHAIR 660/610/1050-1150 (26" x 24" x 38 5/8" - 42 4/8")

CARGO STORAGES

Apart from serving as a pedestal, **CARGO** storage can also work as a desk pedestal or a side panel. Thanks to various configuration options, it can be combined in systems, eliminating desk legs. **CARGO** enables clear organization of office space and it gives it a clear structure.



The top shelf includes pencil tray. The internal structure of a **CARGO** unit divides the space into two equal parts. The spaces between the shelves allow storage of file binders in rows. The base is equipped with rollers which facilitate opening (pulling out) of the internal part of the unit.

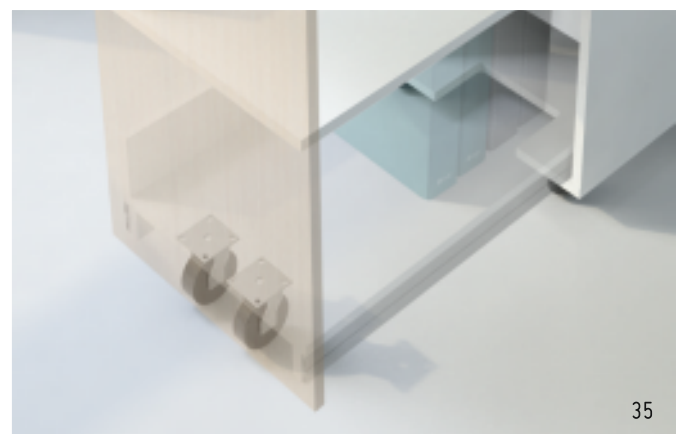



STANDARD PRO AND GLOSS PEDESTALS

A pedestal is a necessary component of any work station. In the **PRO** and **STANDARD** lines, there are groups of fixed pedestals aligned in height with the desk, and mobile pedestals which can additionally be fitted with a cushion, doubling up as a seat. The colour scheme of pedestals perfectly matches **PRO** and **STANDARD** ranges.



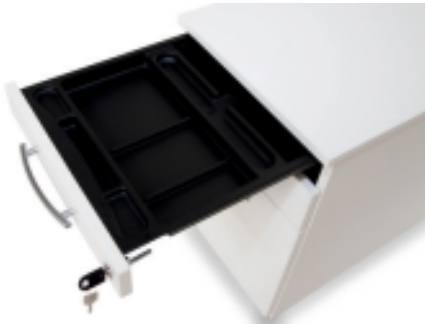

KRT – metal drawers
separate pencil drawer

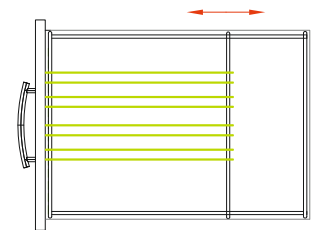
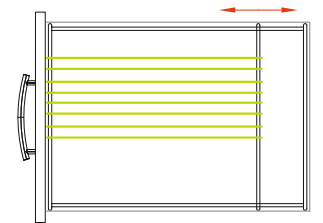
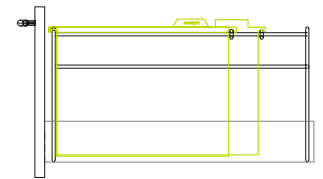

KDT – metal drawer
pencil tray



- To reinforce the structure, an additional roller in the pedestal is designed for versions with a bottom drawer with a file hanger
- KRT pedestals have a separate pencil drawer, and KDT pedestals have a plastic pencil tray in the top drawer
- All pedestals are by default fitted with metal drawers with a central lock and a foldable key, Anti-tilt mechanism and a silent closing system
- Suspension file drawer can be adjusted in width to fit any folder size; 100% extraction
- Castors with breaks
- STANDARD line includes pedestals with an extended top playing a role of a link and expanding the work surface



STANDARD PRO AND GLOSS PEDESTALS

Pedestals come in two basic versions: mobile pedestals of 586 mm height and fixed pedestals of 740 mm in height. Mobile pedestals are available with either 4 or 5 castors. Fixed pedestals have four level adjusters. Pedestals come in two depths: 600 and 800 mm.



KDT74 X 2 PEDESTAL 402/800/740 (15 7/8" x 31 1/2" x 29 1/8")
BAG0218 X 1 OGL_A BENCH 1600/1610/740 (63" x 63 3/8" x 29 1/8")
ZUT16 X 1 TWIN PANEL 1590/30/350 (62 5/8" x 1 1/8" x 13 3/4")

KDT13 X 1 PEDESTAL 402/600/586 (15 7/8" x 23 5/8" x 23 1/8")
SKP13 X 1 PEDESTAL CUSHION 400/600/52 (15 3/4" x 23 5/8" x 2")
BAG048 X 1 OGL_A DESK 1600/800/740 (63" x 31 1/2" x 29 1/8")



SLD13HT PEDESTAL 416/600/587 (16 3/8" x 23 5/8" x 23 1/8")
SLD12HT PEDESTAL 416/600/587 (16 3/8" x 23 5/8" x 23 1/8")



STANDARD pedestals come in two depths: 600 and 800 mm

SLD130 PEDESTAL 416/800/586 (16 3/8" x 31 1/2" x 23 1/8")



SLD - metal drawer

STANDARD AND GLOSS PEDESTALS



SLD – metal drawer
plastic pencil tray



STANDARD and **GLOSS** handle-free pedestals are available in the mobile version in black, aluminium, white and anthracite finish. The front and top of **GLOSS** pedestals is covered with high-gloss HPL.



KD1064 X 2 PEDESTAL 1000/600/740 (39 3/8" x 23 5/8" x 29 1/8")
KD1263 X 2 PEDESTAL 1200/600/740 (47 1/4" x 23 5/8" x 29 1/8")
KRT130 X 1 PEDESTAL 402/800/586 (15 7/8" x 31 1/2" x 23 1/8")
KRT13 X 1 PEDESTAL 402/600/586 (15 7/8" x 23 5/8" x 23 1/8")
IA3104 X 1 STORAGE 801/432/1129 (31 1/2" x 17" x 44 1/2")
IA3404 X 1 STORAGE 801/432/1129 (31 1/2" x 17" x 44 1/2")
IA3504 X 1 STORAGE 801/432/1129 (31 1/2" x 17" x 44 1/2")
A3R02 X 1 MOBILE STORAGE MULTIFUNCTION 550/550/1188 (21 5/8" x 21 5/8" x 46 3/4")
BOQ05 X 4 OG_Q DESK 1800/800/740 (70 7/8" x 31 1/2" x 29 1/8")
CAN11 X 1 CANDE LAMP 1105/360/36 (43 1/2" x 14 1/8" x 14 1/8")
SAVA X 2 CHAIR 660/610/1050-1150 (26" x 24" x 38 5/8" - 42 4/8")



STANDARD PEDESTALS

PEDESTALS offer a multi-purpose solution—always handy. A suitable model from the **STANDARD** range can be selected to meet expectations.





A1L04 X 2 STACK - ON TAMBOUR STORAGE FOR PEDESTAL 800/402/389 (31 1/2" x 15 7/8" x 15 3/8")
PA1L X 2 FABRIC SCREEN FOR STORAGE 461/341/77 (30" x 13 3/8" x 7/8")
IKRT73 X 2 PEDESTALS 402/800/740 (15 7/8" x 31 1/2" x 29 1/8")

Pedestals for various applications offer numerous arrangement options and are useful in daily work, if a cushion is fitted on the top, an extra seat is created.



IKRT13 X 2 PEDESTAL 402/600/586 (15 7/8" x 23 5/8" x 23 1/8")
IA3404 X 2 STORAGE 801/432/1129 (31 1/2" x 17" x 44 1/2")
IA4404 X 2 STORAGE 801/432/1481 (31 1/2" x 17" x 58 1/4")
IAA504 X 1 STORAGE 801/432/1481 (31 1/2" x 17" x 58 1/4")
ZBN18 X 3 YAN_Z BENCH 1800/1600/740 (70 7/8" x 63" x 29 1/8")
ZUS18 X 3 SONIC PANEL 1790/38/350 (70 1/2" x 1 1/2" x 13 3/4")
SAVA X 2 CHAIR 660/610/1050-1150 (26" x 24" x 38 5/8" - 42 4/8")
SNL16 X 2 SUNBEAM LAMP Ø 1440/410 (Ø 56 3/4" x 16 1/8")

PRO PEDESTALS





A **MULTIMEDIA STAND** makes it possible to hold meetings involving multimedia presentations. The base of the table has a space with a door fitted with a push-to-open system. This space may serve as a storage unit to hold various objects.

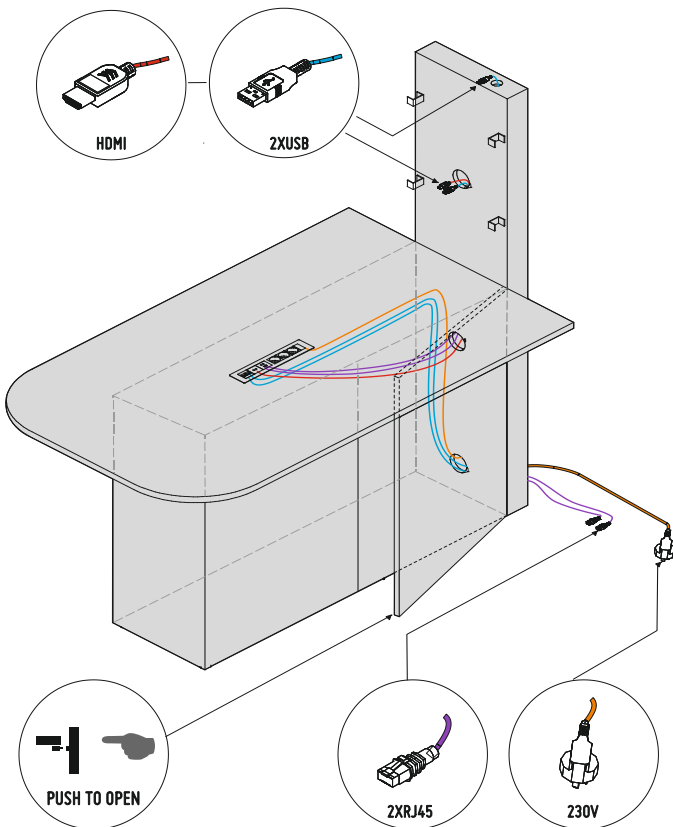
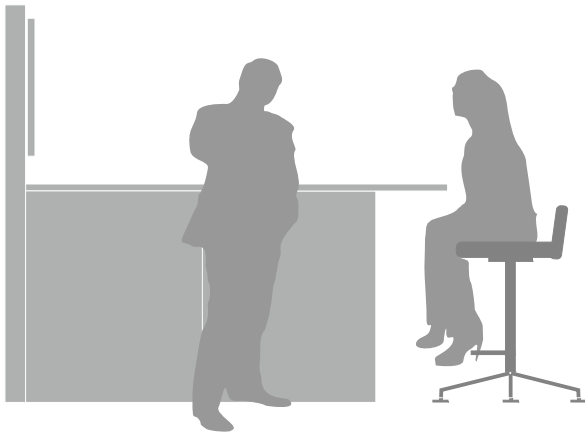

MULTIMEDIA STAND





SNL16 X 1 SUNBEAM Ø 1440/410 (Ø 56 3/4" x 16 1/8")

SSL15 X 2 ELLIPSE 1500/590/300 (59" x 23 1/4" x 11 3/4")



CAN11 X 1 CANOE LAMP 1105/360/360 (43 1/2" x 14 1/8" x 14 1/8")



LAMPS

Office lighting does not always have to be associated with banal forms. Four **LAMP** models demonstrate an unconventional approach to the shape and form, which gives the office a dynamic and modern look.

SNA20 X1 SNAKE LAMP 200/90/150 (78 3/4" x 3 1/2" x 5 7/8")





WS04 X 1 HANGER 800/400/1760 (31 1/2" x 15 3/4" x 69 1/4")
WS05 X 2 HANGER 480/1700 (18 7/8" x 66 7/8")



WS07 X 1 HANGER 1200/60/112 (47 1/4" x 2 3/8" x 4 3/8")

WS02 X 1 HANGER 600/600/1900 (23 5/8" x 23 5/8" x 74 3/4")
WS03 X 1 HANGER 900/600/1900 (35 3/8" x 23 5/8" x 74 3/4")



The **HANGER** with a body made of MFC is a well thought-out model which can be put together with cabinets from the PRO, STANDARD and BASIC lines.

HANGERS

Metal **HANGERS** offer minimalist form and modern design. They have a polished steel rod capable of bearing high loads. They come in two colours: black or white. Complements to their design, they perfectly match any interior.

WS04 X 1 HANGER 800/400/1760 (31 1/2" x 15 3/4" x 69 1/4")
SLD13 X 1 PEDESTAL 416/600/586 (16 3/8" x 23 5/8" x 23 1/8")
BA612 X 1 OGL_A RADIAL DESK 2343/2029/740 (92 1/4" x 79 7/8" x 29 1/8")
ZOS78 X 3 SONIC - VERTICAL ACOUSTIC PANEL FOR BENCH DESK 780/30/350 (30 3/4" x 1 1/8" x 13 3/4")

BASIC

STANDARD

PRO

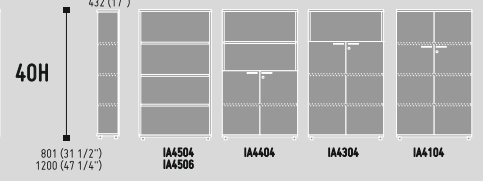
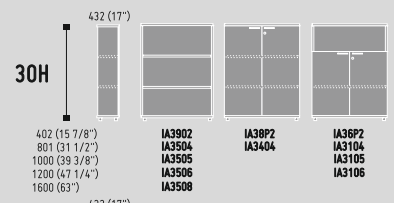
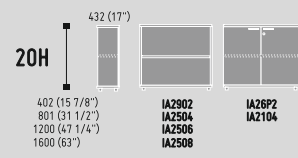
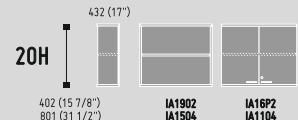
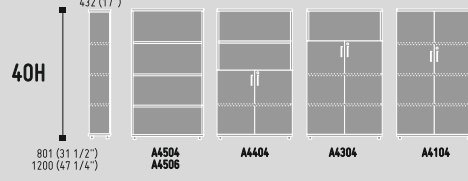
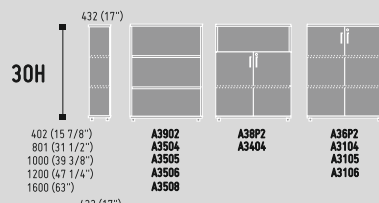
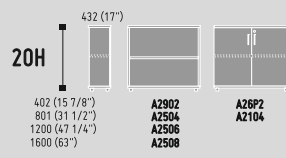
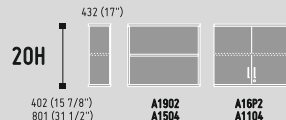
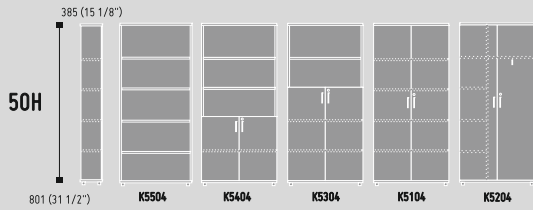
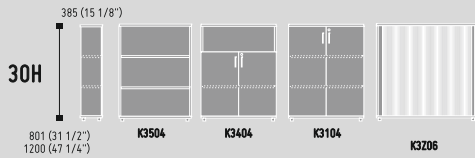
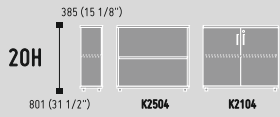
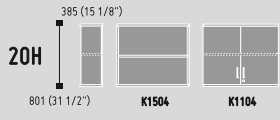

PEDESTALS

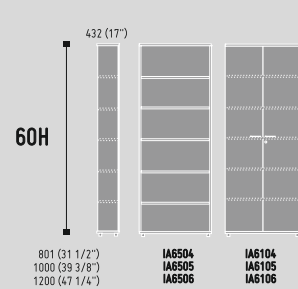
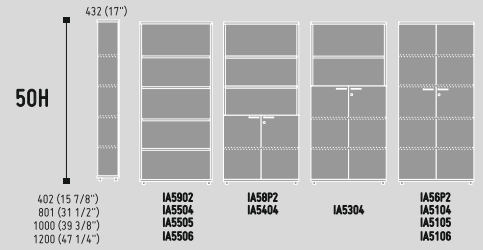
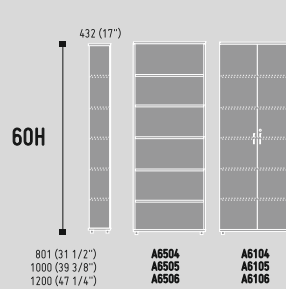
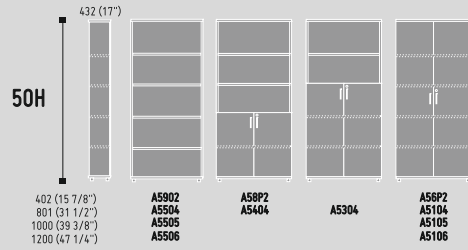
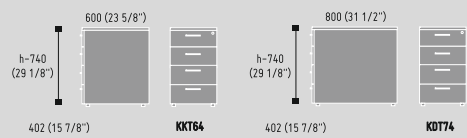
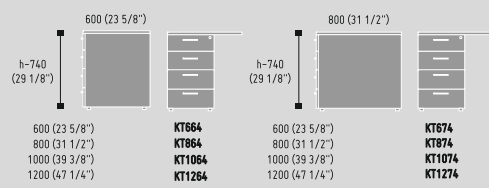

GLASS DOORS

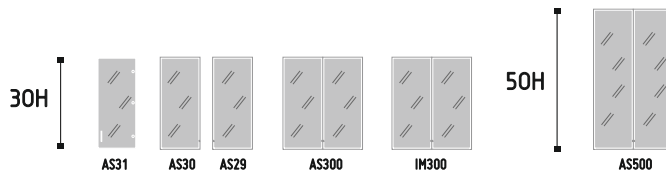

STANDARD / PRO

METAL SHELVES/FILE

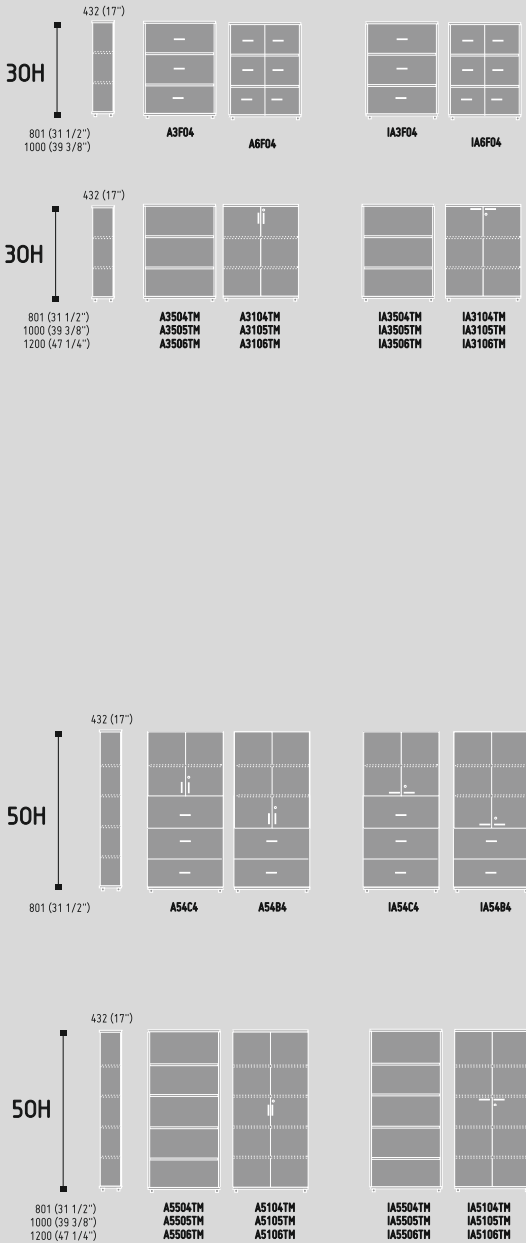

SLIDING DOORS

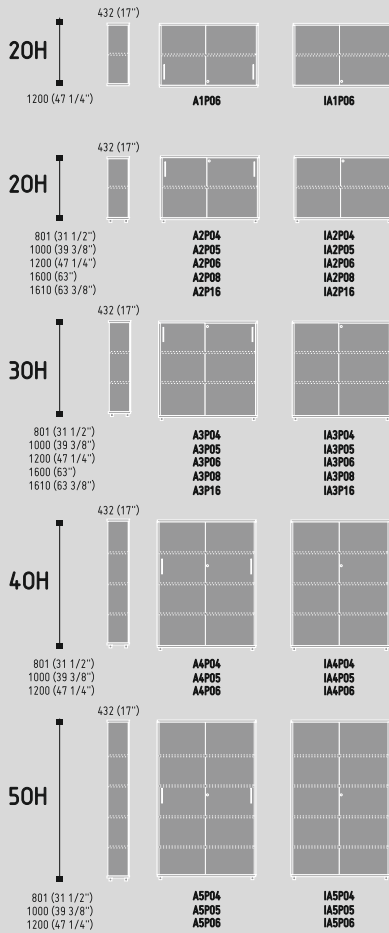

TAMBOURS

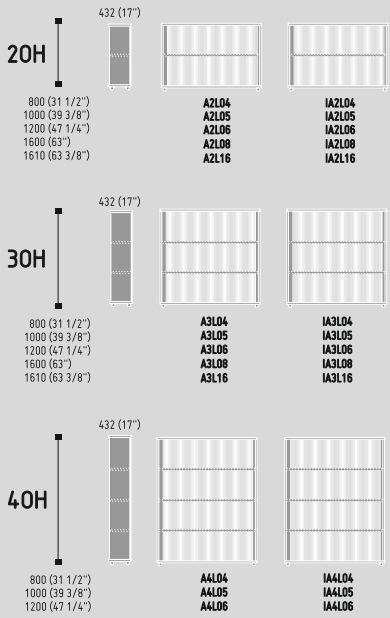

STANDARD / PRO

GLOSS DOORS

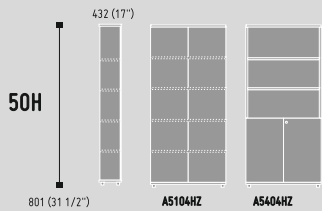
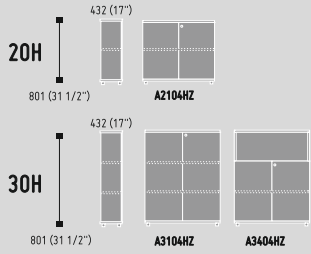

SPECIAL STORAGES

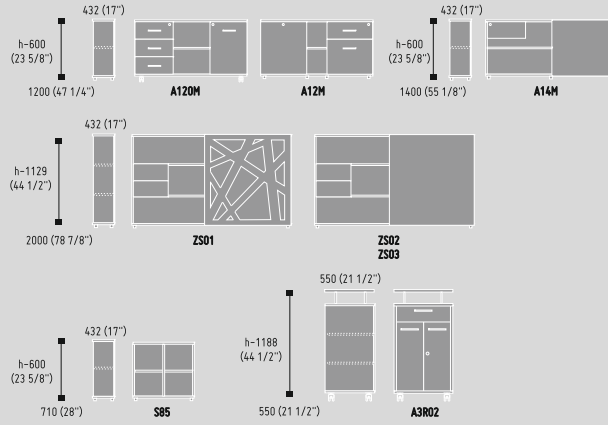

LOCKER STORAGES

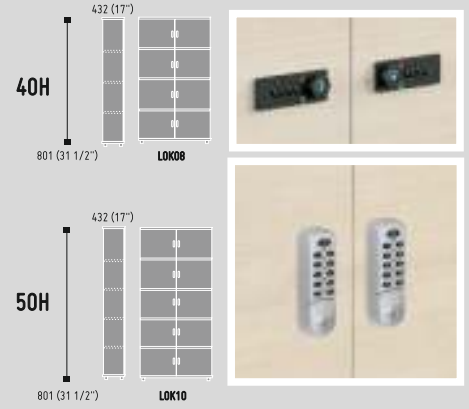

MULTIMEDIA STAND

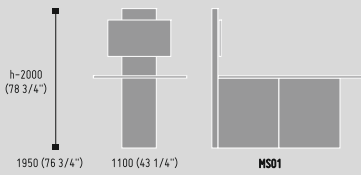

CARGO

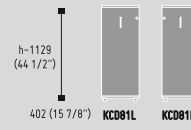

WARDROBE

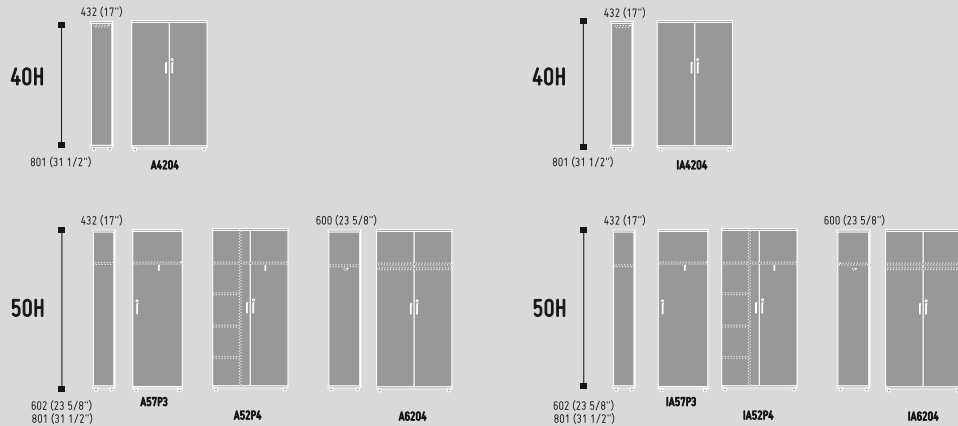

STANDARD

PRO

PEDESTALS

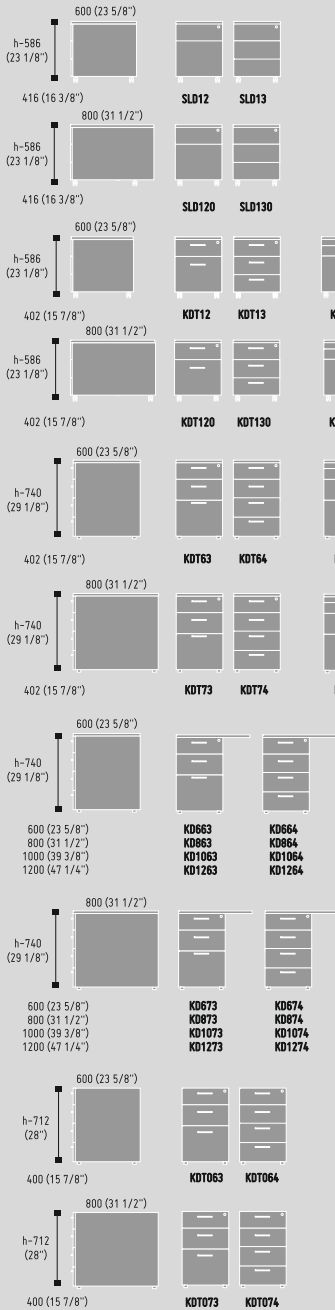

GLOSS PEDESTALS

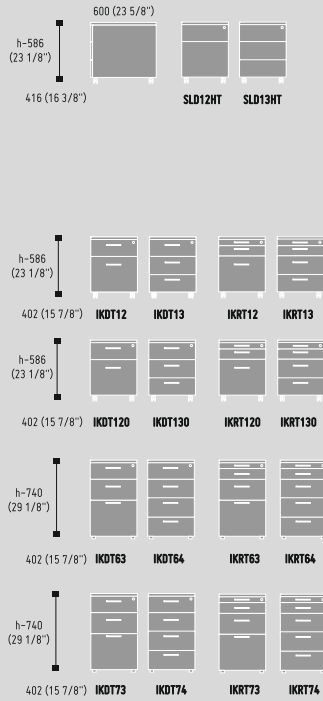

LAMPS

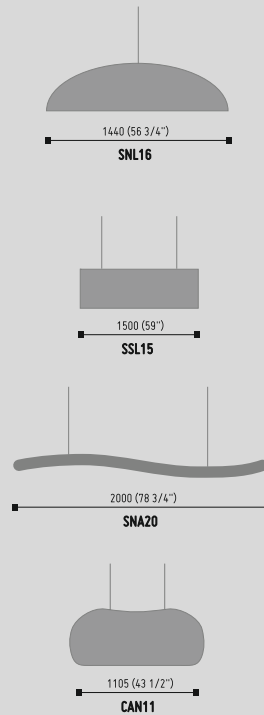

HANGERS

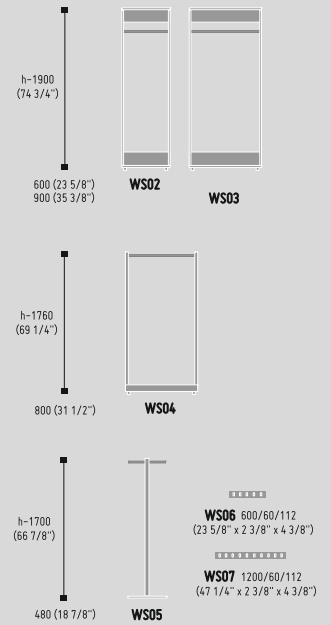

PEDESTAL ELEMENTS

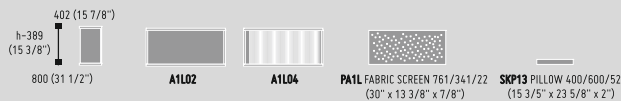

FULL OFFER OF CABINETS, PARTITIONS SCREENS AND PEDESTALS AVAILABLE AT WWW.MDD.EU

Images in the catalogue may show products slightly differently from the original version. Colours of shown materials may differ from the real ones. The producer reserves a right to introduce changes of colours and patterns of the presented products. The manufacturer reserves the right to introduce alterations to the products and their marking without changing the general design. The present catalogue does not constitute a legally binding offer and is published solely for information purposes. Order may be placed only on the basis of the current price lists, available at authorised distributors.

